

Ubuntu Server is a version of the Ubuntu operating system designed and engineered as a backbone for the internet.

Ubuntu Server brings economic and technical scalability to your datacentre, public or private. Whether you want to deploy an OpenStack cloud, a Kubernetes cluster or a 50,000-node render farm, Ubuntu Server delivers the best value scale-out performance available.

In this documentation

Tutorials

Get started - a hands-on introduction to Ubuntu Server for new users

Explanation

Concepts - discussion and clarification of key topics

How-to guides

Step-by-step guides covering key operations and commands

Reference

Technical information - package specifications, APIs, and more

Project and community

Ubuntu Server is a member of the Ubuntu family. It's an open source project that welcomes community projects, contributions, suggestions, fixes and constructive feedback.

If you find any errors or have suggestions for improvements to pages, please use the link at the bottom of each topic titled: "Help improve this document in the forum." This link will take you to the Server Discourse forum for the specific page you are viewing. There you can share your comments or let us know about bugs with any page.

- [Read our Code of Conduct](#)
- [Get support](#)
- [Join the Discourse forum](#)
- [Download](#)

Thinking about using Ubuntu Server for your next project? [Get in touch!](#)

PDFs and previous releases

Below are links to the previous Ubuntu Server release server guides as well as an offline copy of the current version of this site:

Ubuntu 20.04 LTS (Focal Fossa) and later: [PDF](#)

Ubuntu 18.04 LTS (Bionic Beaver): [Web](#) and [PDF](#)

Navigation

Navigation

Level	Path	Navlink
0		Introduction
0		
1	tutorials	Tutorials
2		Core tutorial
3	installation	Basic installation
3	install/general	How to operate the server installer
3	install/step-by-step	Screen-by-screen installer guide
3	install/storage	Configuring storage
2		Next steps
3	install/subscription	Attach your Ubuntu Pro subscription
3	install/reporting-problems	Report a problem with the installer
0		
1	how-to	How-to guides
2		Advanced installation
3	install/netboot-amd64	amd64 netboot install
3	install/netboot-arm64	arm64 netboot install
3	install/netboot-ppc64el	ppc64el netboot install
3	install/ppc64el	Virtual CDROM and Petitboot on ppc64el
3	install/s390x-zvm	s390x install via z/VM

Level	Path	Navlink
3	install/s390x-lpar	s390x install via LPAR
2		Automatic installation
3	install/autoinstall	Introduction
3	install/autoinstall-quickstart	Autoinstall quickstart
3	install/autoinstall-quickstart-s390x	Autoinstall quickstart on s390x
3	install/autoinstall-reference	Autoinstall reference
3	install/autoinstall-schema	Autoinstall schema
3	install/vm-autoinstall-on-s390x	z/VM autoinstall on s390x
3	install/lpar-autoinstall-on-s390x	LPAR autoinstall on s390x
2		ROCK Images
3	rock-images/introduction	Introduction
3	rock-images/container-customization-with-docker	Container customization with Docker
3	rock-images/multi-node-configuration-with-docker-compose	Multi-node configuration with Docker-Compose
2		Software
3	package-management	Package management
3	upgrade-introduction	Upgrade
3	reporting-bugs	Reporting bugs
3	kernel-crash-dump	Kernel crash dump
2		OpenLDAP
3	service-ldap-introduction	Introduction
3	service-ldap	Installation
3	service-ldap-access-control	Access control
3	service-ldap-replication	Replication
3	service-ldap-usage	Simple LDAP user and group management
3	service-ldap-with-tls	SSL/TLS
3	service-ldap-backup-restore	Backup and restore
2		Samba
3	samba-active-directory	Joining Active Directory
3	samba-file-server	File server
3	samba-print-server	Print server
3	samba-share-access-control	Share access controls
3	samba-apparmor-profile	AppArmor profile
3		Legacy pages
4	samba-domain-controller	NT4 domain controller
4	samba-openldap-backend	OpenLDAP backend
2		Kerberos
3	kerberos-introduction	Introduction
3	service-kerberos	Kerberos server
3	service-kerberos-principals	Service principals
3	kerberos-encryption-types	Kerberos encryption types
3	service-kerberos-secondary-kdc	Secondary KDC
3	service-kerberos-workstation-auth	Basic workstation authentication
3	service-kerberos-with-openldap-backend	Kerberos with OpenLDAP backend
2		Network user authentication with SSSD
3	service-sssd	Introduction
3	service-sssd-ad	Active Directory
3	service-sssd-ldap	LDAP
3	service-sssd-ldap-krb	LDAP and Kerberos
3	service-sssd-troubleshooting	Troubleshooting
2		WireGuard VPN
3	wireguard-vpn-introduction	Introduction
3		Peer-to-site
4	wireguard-vpn-peer2site-introduction	Introduction
4	wireguard-vpn-peer2site-router	On router
4	wireguard-vpn-peer2site-inside	Inside device
3	wireguard-vpn-site2site	Site-to-site
3	wireguard-vpn-defaultgw	Default gateway
3	wireguard-vpn-other-tasks	Other tasks
3	wireguard-vpn-security	Security tips
3	wireguard-vpn-troubleshooting	Troubleshooting
0		

Level	Path	Navlink
1	explanation	Explanation
2		Software
3	about-apt-upgrade-and-phased-updates	About apt upgrade and phased updates
3	changing-package-files	Changing package files
2		Network
3	network-introduction	Introduction
3	network-configuration	Configuration
3	network-dhcp	DHCP
3	network-ntp	NTP
3	network-dpdk	DPDK
3	openvswitch-dpdk	OpenVswitch-DPDK
2		Cryptography
3	introduction-to-crypto-libraries	Introduction to crypto libraries
3	openssl	OpenSSL
3	gnutls	GnuTLS
3	network-security-services-nss	Network Security Services (NSS)
3	java-cryptography-configuration	Java cryptography configuration
3	bind-9-dnssec-cryptography-selection	BIND 9 DNSSEC cryptography selection
3	openssh-crypto-configuration	OpenSSH crypto configuration
3	troubleshooting-tls-ssl	Troubleshooting TLS/SSL
2		Introduction to...
3	samba-introduction	Samba
0		
1	reference	Reference
2		Cloud Images
3	cloud-images/introduction	Introduction
3	cloud-images/amazon-ec2	Amazon EC2
3	cloud-images/google-cloud-engine	Google Compute Engine (GCE)
3	find-ubuntu-images-on-azure	Microsoft Azure
2		Multipath
3	device-mapper-multipathing-introduction	Introduction
3	device-mapper-multipathing-configuration	Configuration
3	device-mapper-multipathing-setup	Setup
3	device-mapper-multipathing-usage-debug	Usage and debug
2		Security
3	security-introduction	Introduction
3	security-users	Users
3	security-smart-cards	Smart cards
4	security-smart-cards-ssh	SSH
3	security-apparmor	AppArmor
3	security-firewall	Firewall
3	security-certificates	Certificates
3	security-trust-store	CA trust store
3	security-console	Console
2		Virtualisation
3	virtualization-introduction	Introduction
3	virtualization-qemu	QEMU
3	virtualization-libvirt	libvirt
3	virtualization-openstack	OpenStack
3	virtualization-multipass	Multipass
3	virtualization-uvtool	uvtools
3	virtualization-virt-tools	Virtualisation tools
2		Containers
3	containers-lxd	LXD
3	containers-lxc	LXC
2		High Availability
3	ubuntu-ha-introduction	Introduction
3	ubuntu-ha-pacemaker-resource-agents	Pacemaker - resource agents
3	ubuntu-ha-pacemaker-fence-agents	Pacemaker - fence agents
3	ubuntu-ha-drbd	Distributed Replicated Block Device (DRBD)
3	ubuntu-ha-migrate-from-crmsch-to-pcs	Ubuntu HA - Migrate from crmsch to pcs

Level	Path	Navlink
2		Databases
3	databases-introduction	Introduction
3	databases-mysql	MySQL
3	databases-postgresql	PostgreSQL
2		Monitoring
3	logging-monitoring-alerting	Logging, Monitoring and Alerting (LMA)
3	monitoring-nagios-munin	Nagios and Munin
3	logwatch	Tools - Logwatch
2		Backups
3	backups-introduction	Introduction
3	backups-archive-rotation	Archive rotation
3	backups-bacula	Bacula
3	backups-shell-scripts	Shell scripts
3	tools-rsnapshot	Rsnapshot
2		Mail Services
3	mail-introduction	Introduction
3	mail-dovecot	Dovecot
3	mail-exim4	Exim4
3	mail-postfix	Postfix
2		Web Services
3	web-servers-introduction	Introduction
3	web-servers-apache	Apache
3	proxy-servers-squid	Squid proxy servers
3	lamp-applications	LAMP applications
3	programming-php	PHP programming
3	programming-ruby-on-rails	Ruby on Rails programming
2		Other Services
3	service-cups	CUPS
3	service-debuginfod	Debuginfod
4	service-debuginfod-faq	Debuginfod FAQ
3	service-domain-name-service-dns	Domain Name Service (DNS)
3	service-ftp	FTP
3	service-iscsi	iSCSI
3	service-nfs	NFS
3	service-openssh	OpenSSH
3	service-openvpn	OpenVPN
3	service-gitolite	gitolite
3	vpn-clients	VPN clients
2		Tools
3	tools-byobu	byobu
3	tools-etckeeper	etckeeper
3	tools-munin	munin
3	tools-nagios	nagios
3	pam-motd	pam_motd
3	tools-puppet	Puppet

Redirects

Mapping table

Path	Location
/server/docs/introduction	Ubuntu Server documentation
/server/docs/installation-advanced	Advanced Installation
/server/docs/installation-iscsi	Installation - iSCSI
/server/docs/security-ecryptfs	eCryptfs is deprecated

This section of our documentation contains step-by-step tutorials to help outline what Ubuntu Server is capable of while helping you achieve specific aims.

We hope our tutorials make as few assumptions as possible and are broadly accessible to anyone with an interest in Ubuntu Server. They should also be a good place to start learning about Ubuntu Server in general, how it works, and what it's capable of.

Core tutorial

In our **core tutorial**, you will learn how to set up an Ubuntu Server; from installing using a bootable USB device, to navigating the Server installer menu.

Getting started	Basic installation
The Server installer	How to operate the Server installer Screen-by-screen installer guide Configuring storage

Next steps

Once your Ubuntu Server is up and running, you may be interested in this collection of related tutorials and topics that will help you learn more about how it works and what's available to you. These pages can be viewed in any order.

Ubuntu Pro	Attach your Ubuntu Pro subscription
The Server installer	Report a problem with the installer

If you have a specific goal, but are already familiar with Ubuntu Server, take a look at our *How-to* guides. These have more in-depth detail and can be applied to a broader set of applications.

Take a look at our *Reference* section when you need to determine what commands are available, and how to interact with various tools.

Finally, for a better understanding of how Ubuntu Server works and how it can be used and configured, our *Explanation* section enables you to expand your knowledge of the operating system and additional software.

This chapter provides an overview of how to install Ubuntu Server Edition. You can also refer to this guide on [how to operate the installer](#) for more information on using the installer, and to this [screen-by-screen reference guide](#) for more information about each of the installer screens.

Preparing to install

This section explains various aspects to consider before starting the installation.

System requirements

Ubuntu Server Edition provides a common, minimalist base for a variety of server applications, such as file/print services, web hosting, email hosting, etc. This version supports four 64-bit architectures:

- amd64 (Intel/AMD 64-bit)
- arm64 (64-bit ARM)
- ppc64el (POWER8 and POWER9)
- s390x (IBM Z and LinuxONE)

The recommended system requirements are:

- CPU: 1 gigahertz or better
- RAM: 1 gigabyte or more
- Disk: a minimum of 2.5 gigabytes

Perform a system back up

Before installing Ubuntu Server Edition you should make sure all data on the system is backed up.

If this is not the first time an operating system has been installed on your computer, it is likely you will need to re-partition your disk to make room for Ubuntu.

Any time you partition your disk, you should be prepared to lose everything on the disk should you make a mistake or something goes wrong during partitioning. The programs used in installation are quite reliable, most have seen years of use, but they also perform destructive actions.

Download the server ISO

You can obtain the amd64 server download from <https://releases.ubuntu.com/>. Select the version you wish to install and select the “server install image” download. Note that the server download includes the installer.

There are platform specific how-to guides for installations on:

- [s390x LPAR](#)
- [z/VM](#)
- [ppc64el](#)

Create a bootable USB

There are many ways to boot the installer but the simplest and most common way is to [create a bootable USB stick](#) to boot the system to be installed with ([tutorials for other operating systems](#) are also available).

Boot the installer

Plug the USB stick into the system to be installed and start it.

Most computers will automatically boot from USB or DVD, though in some cases this is disabled to improve boot times. If you don't see the boot message and the “Welcome” screen which should appear after it, you will need to set your computer to boot from the install media.

There should be an on-screen message when the computer starts telling you what key to press for settings or a boot menu. Depending on the manufacturer, this could be Escape, F2, F10 or F12. Simply restart your computer and hold down this key until the boot menu appears, then select the drive with the Ubuntu install media.

If you are still having problems, check out the [Ubuntu Community documentation on booting from CD/DVD](#).

After a few moments, the installer will start in its language selection screen.

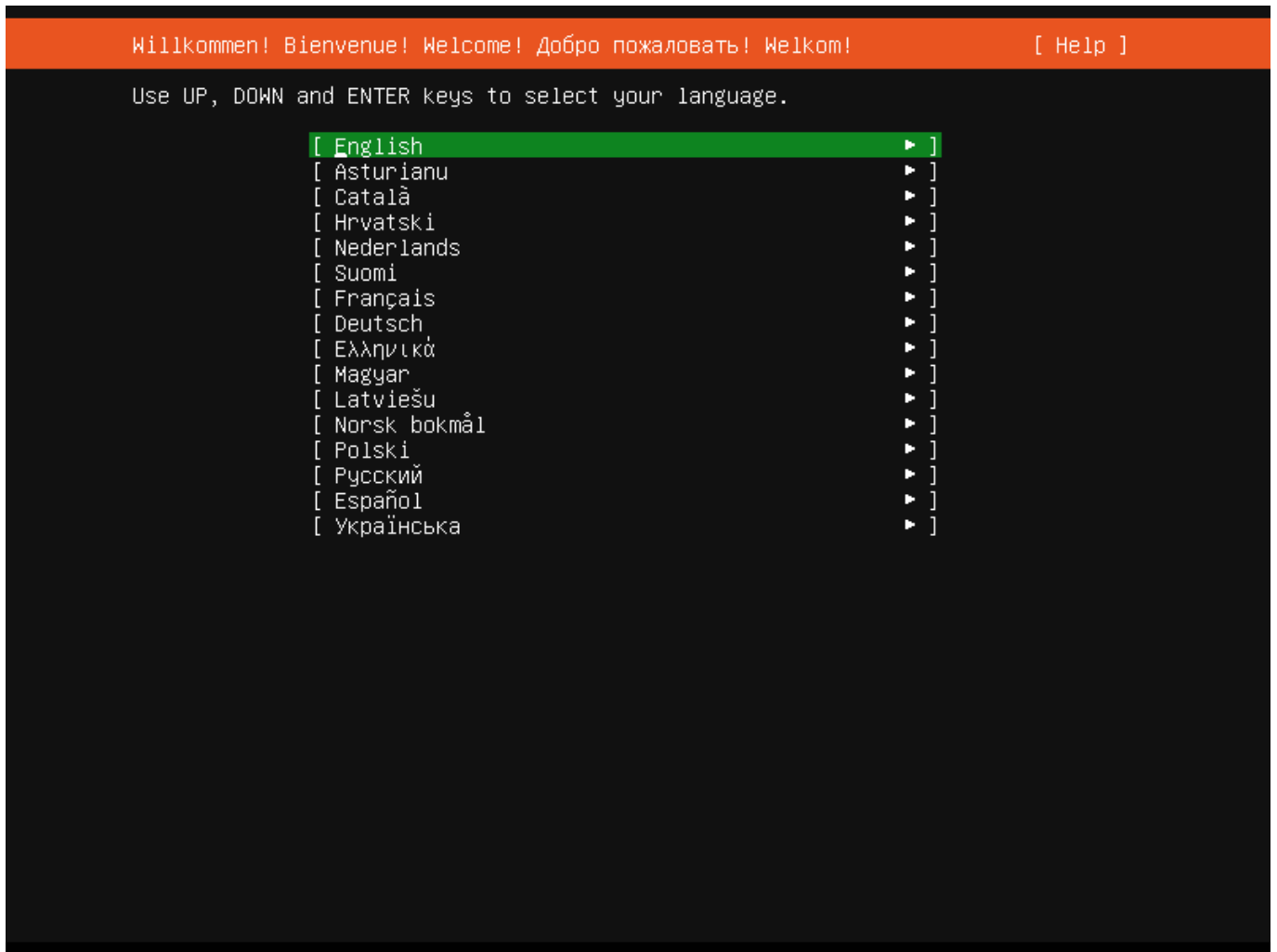

Using the installer

The installer is designed to be easy to use and have sensible defaults so for a first install you can mostly just accept the defaults for the most straightforward install:

- Choose your language
- Update the installer (if offered)
- Select your keyboard layout
- Do not configure networking (the installer attempts to configure wired network interfaces via DHCP, but you can continue without networking if this fails)
- Do not configure a proxy or custom mirror unless you have to in your network
- For storage, leave “use an entire disk” checked, and choose a disk to install to, then select “Done” on the configuration screen and confirm the install
- Enter a username, hostname and password
- On the SSH and snap screens, select “Done”
- You will now see log messages as the install is completed
- Select restart when this is complete, and log in using the username and password provided

This document explains how to use the installer in general terms. For a step-by-step guide through the screens of the installer, you can use our [screen-by-screen reference guide](#).

Get the installer

Installer images are made (approximately) daily and are available from <https://cdimage.ubuntu.com/ubuntu-server/daily-live/current/>. These are not tested as extensively as the images from release day, but they contain the latest packages and installer, so fewer updates will be required during or after installation.

You can download the server installer for amd64 from <https://ubuntu.com/download/server> and other architectures from <http://cdimage.ubuntu.com/releases/20.04/release/>.

Installer UI navigation

In general, the installer can be used with the up and down arrows and space or Enter keys and a little typing.

Tab and Shift + Tab move the focus down and up respectively. Home / End / Page Up / Page Down can be used to navigate through long lists more quickly in the usual way.

Running the installer over serial

By default, the installer runs on the first virtual terminal, `tty1`. This is what is displayed on any connected monitor by default. However, servers do not always have a monitor. Some out-of-band management systems provide a remote virtual terminal, but some times it is necessary to run the installer on the serial port. To do this, the kernel command line needs to [have an appropriate console](#) specified on it – a common value is `console=ttyS0` but this is not something that can be generically documented.

When running on serial, the installer starts in a basic mode that does using only the ASCII character set and black and white colours. If you are connecting from a terminal emulator such as `gnome-terminal` that supports Unicode and rich colours you can switch to “rich mode” which uses Unicode, colours and supports many languages.

Connecting to the installer over SSH

If the only available terminal is very basic, an alternative is to connect via SSH. If the network is up by the time the installer starts, instructions are offered on the initial screen in basic mode. Otherwise, instructions are available from the help menu once networking is configured.

In addition, connecting via SSH is assumed to be capable of displaying all Unicode characters, enabling more translations to be used than can be displayed on a virtual terminal.

Help menu

The help menu is always in the top right of the screen. It contains help – both general and for the currently displayed screen – and some general actions.

Switching to a shell prompt

You can switch to a shell at any time by selecting “Enter shell” from the help menu, or pressing Control + Z or F2.

If you are accessing the installer via `tty1`, you can also access a shell by switching to a different virtual terminal (Control + Alt + arrow, or Control + Alt + number keys, move between virtual terminals).

Global keys

There are some global keys you can press at any time:

Key	Action
ESC	Go back
F1	Open help menu
Control + Z, F2	Switch to shell
Control + L, F3	Redraw screen
Control + T, F4	Toggle rich mode (colour, Unicode) on and off

The installer is designed to be easy to use without the need to refer to documentation. However, this reference guide provides more information for each of the screens of the installer.

Language selection

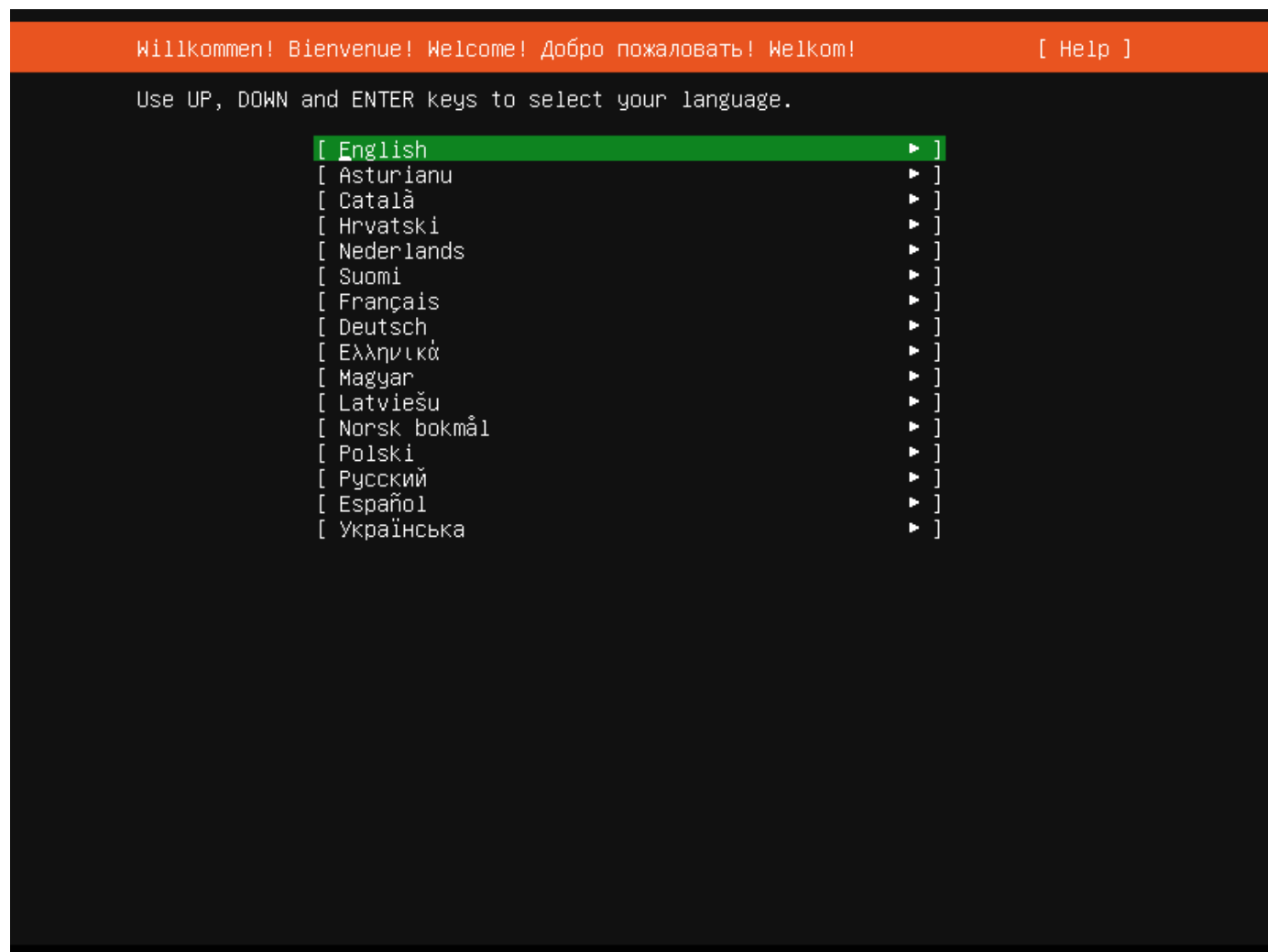

This screen selects the language for the installer and the default language for the installed system.

More languages can be displayed if you [connect via SSH](#).

Refresh

```
Installer update available [ Help ]

Version 20.05.2 of the installer is now available (20.04.3 is currently
running).

You can read the release notes for each version at:

    https://github.com/CanonicalLtd/subiquity/releases

If you choose to update, the update will be downloaded and the installation
will continue from here.

[ Update to the new installer ]
[ Continue without updating ]
[ Back ]
```

This screen is shown if there is an update for the installer available. This allows you to get any improvements and bug fixes made since release.

If you choose to update, the new version will be downloaded and the installer will restart at the same point of the installation.

Keyboard

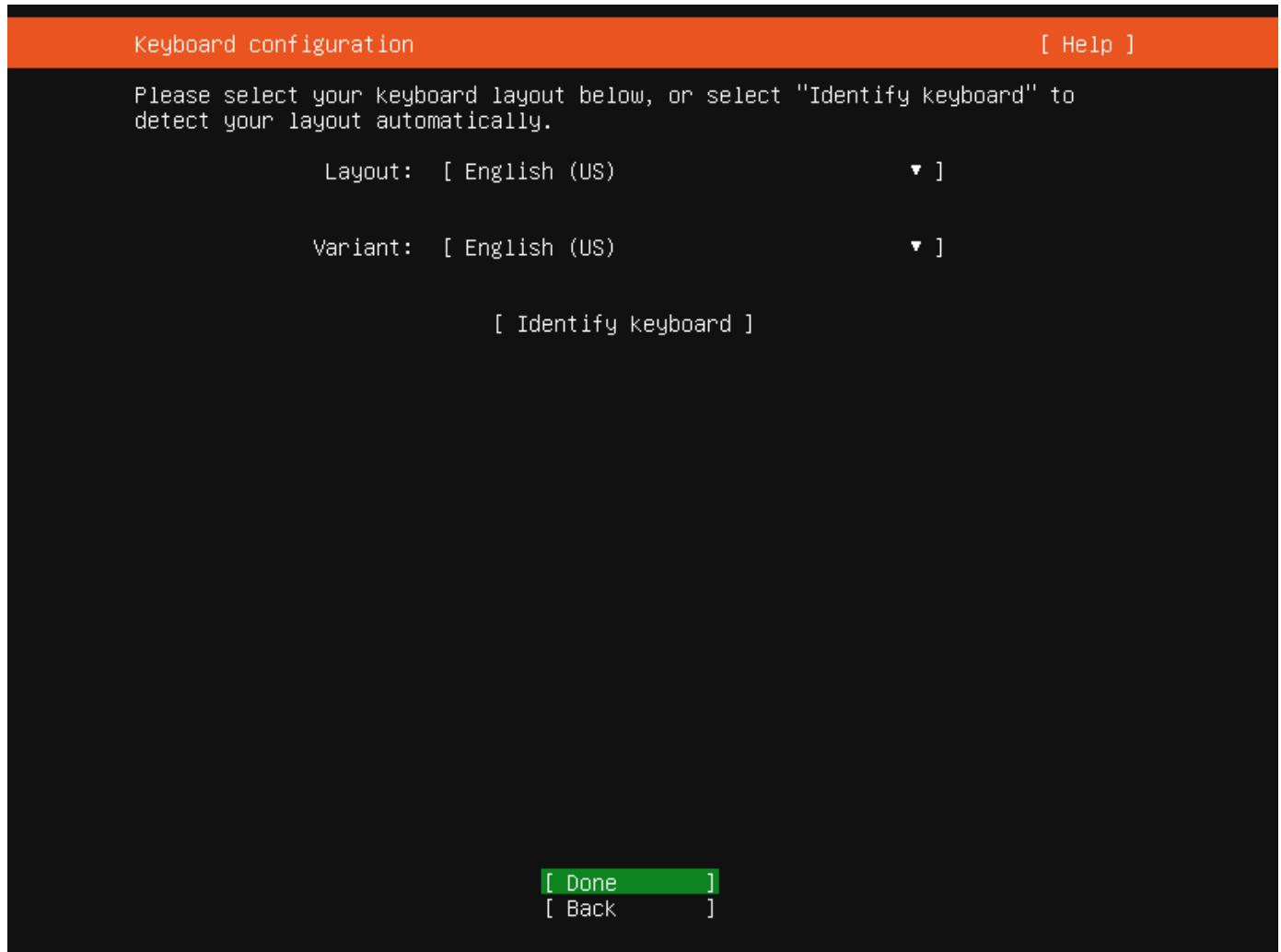

Choose the layout and variant of keyboard attached to the system, if any. When running in a virtual terminal, it is possible to guess the layout and variant by answering questions about the keyboard.

Zdev (s390x only)

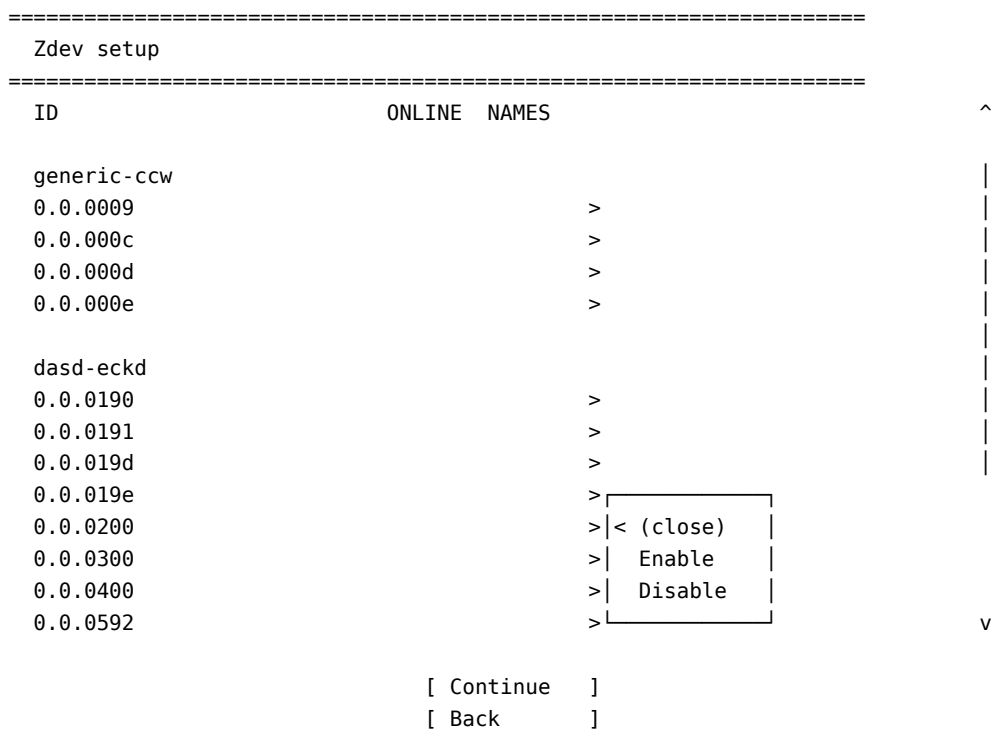

This screen is only shown on s390x and allows z-specific configuration of devices.

The list of devices can be long. Home / End / Page Up / Page Down can be used to navigate through the list more quickly.

Network

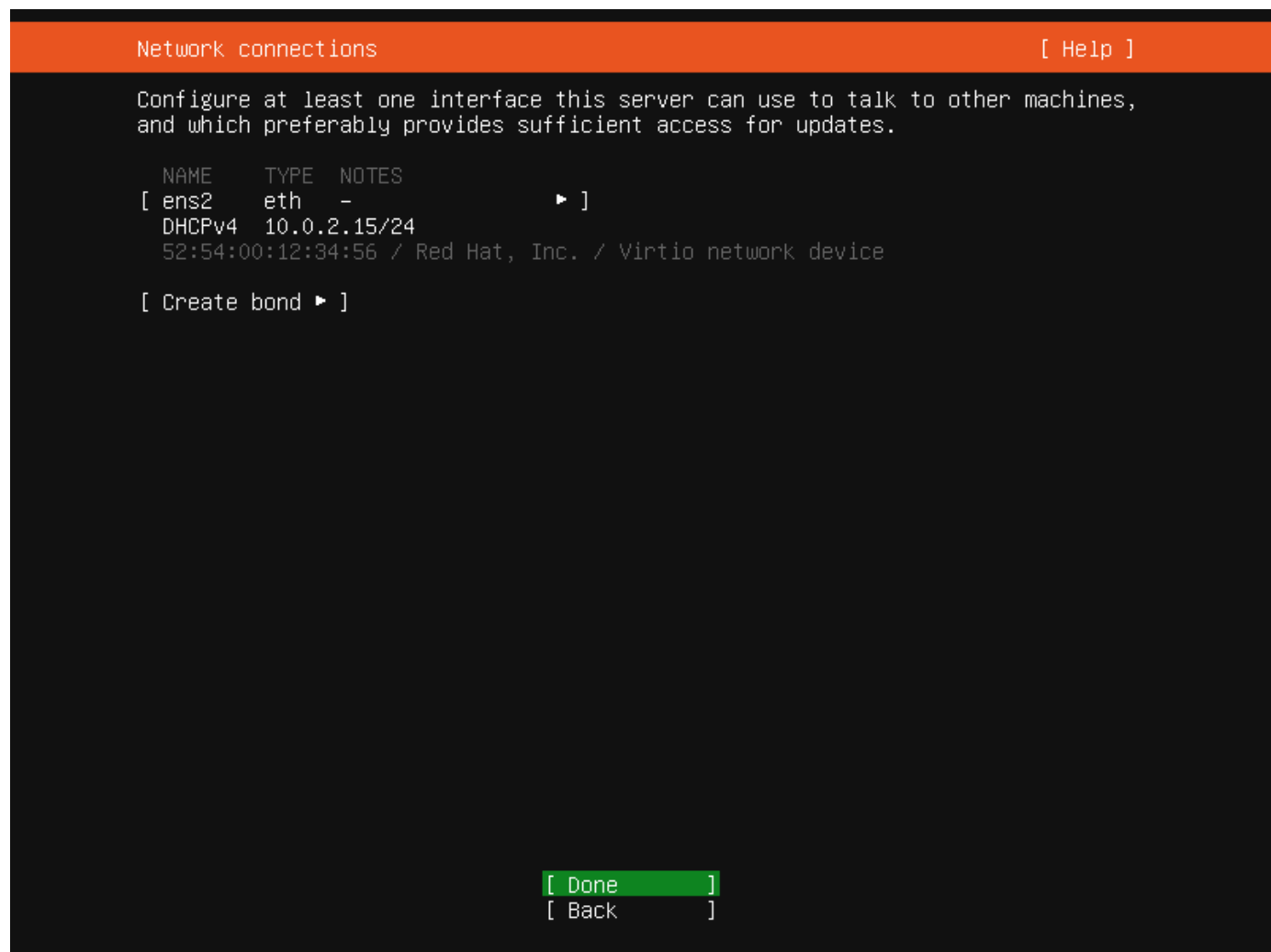

network800×600 2.99 KB

This screen allows the configuration of the network. Ubuntu Server uses NetPlan to configure networking and the UI of the installer can configure a subset of NetPlan’s capabilities. In particular it can configure DHCP or static addressing, VLANs and bonds.

If networking is present (defined as “at least one interface has a default route”) then the installer will install updates from the archive at the end of installation.

Proxy

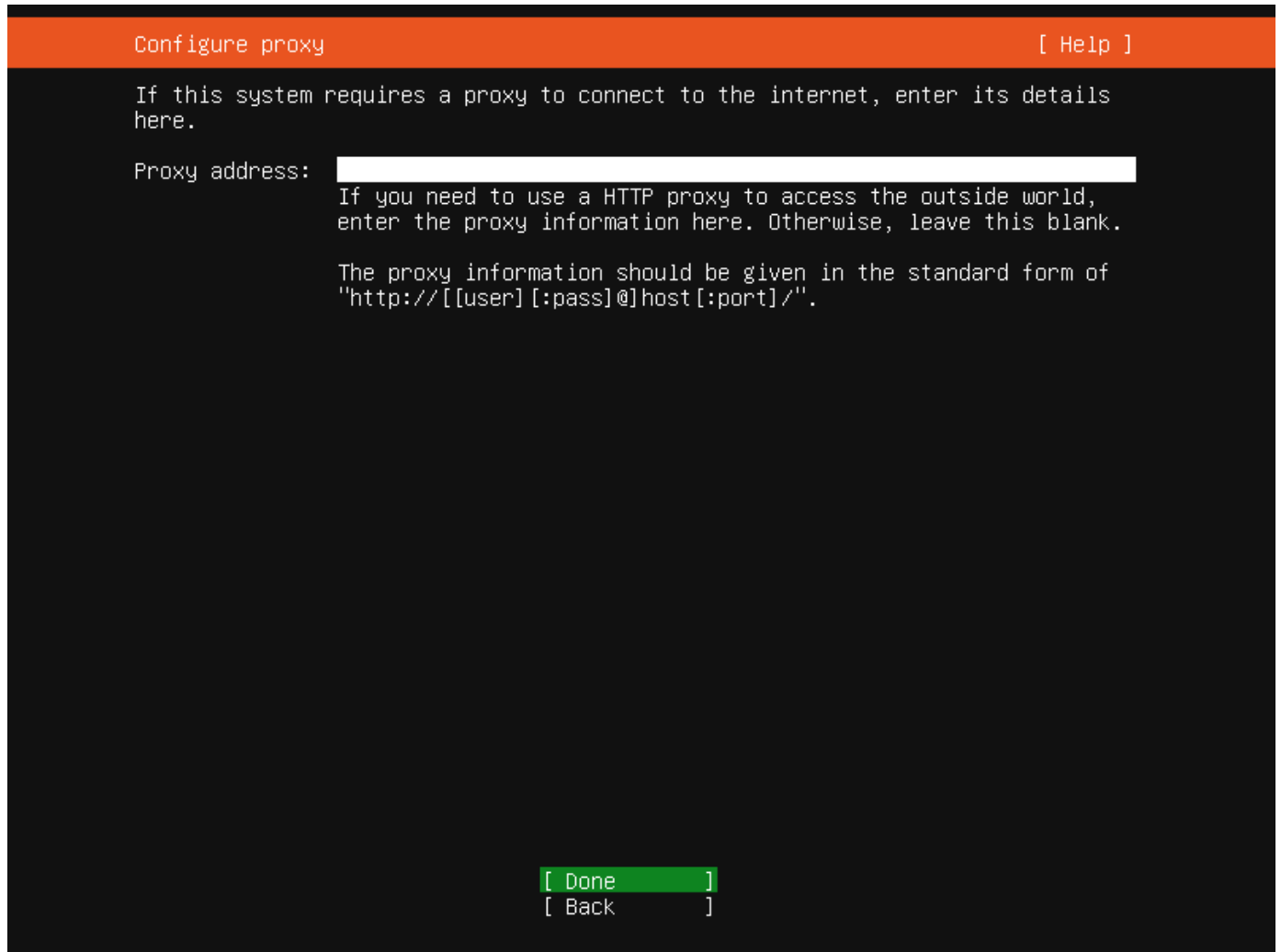

proxy800×600 2.69 KB

The proxy configured on this screen is used for accessing the package repository and the snap store both in the installer environment and in the installed system.

Mirror

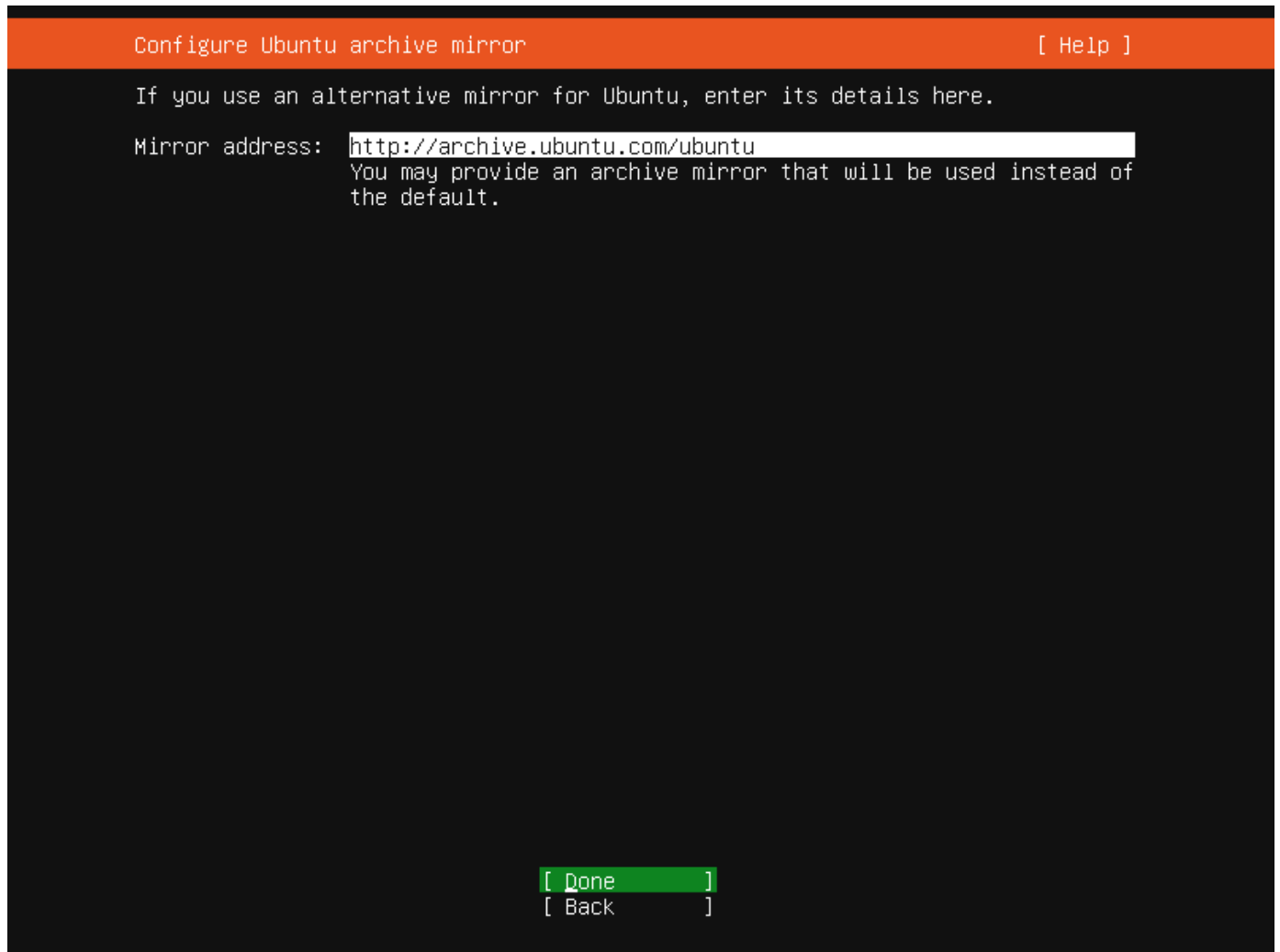

mirror800×600 1.99 KB

The installer will attempt to use `geoip` to look up an appropriate default package mirror for your location. If you want or need to use a different mirror, enter its URL here.

Storage

```
Storage configuration [ Help ]

FILE SYSTEM SUMMARY

MOUNT POINT      SIZE      TYPE      DEVICE TYPE
[ /              9.997G   new ext4  new partition of local disk ▶ ]

AVAILABLE DEVICES

No available devices

[ Create software RAID (md) ▶ ]
[ Create volume group (LVM) ▶ ]

USED DEVICES

DEVICE           TYPE      SIZE
[ /dev/vda       local disk 10.000G ▶ ]
partition 1     new, bios_grub 1.000M ▶ ]
partition 2     new, to be formatted as ext4, mounted at / 9.997G ▶ ]

[ Done ]
[ Reset ]
[ Back ]
```

storage_config800×600 3.89 KB

Storage configuration is a complicated topic and [has its own page for documentation](#).

FILE SYSTEM SUMMARY

MOUNT POINT	SIZE	TYPE	DEVICE TYPE
[/	9.997G	new ext4	new partition of local disk ▶]

AVAILABLE DEVICES

No available devices

Confirm destructive action

Selecting Continue below will begin the installation process and result in the loss of data on the disks selected to be formatted.

You will not be able to return to this or a previous screen once the installation has started.

Are you sure you want to continue?

[No]
[Continue]

[Done]
[Reset]
[Back]

storage_confirm800×600 3.71 KB

Once the storage configuration is confirmed, the install begins in the background.

Identity

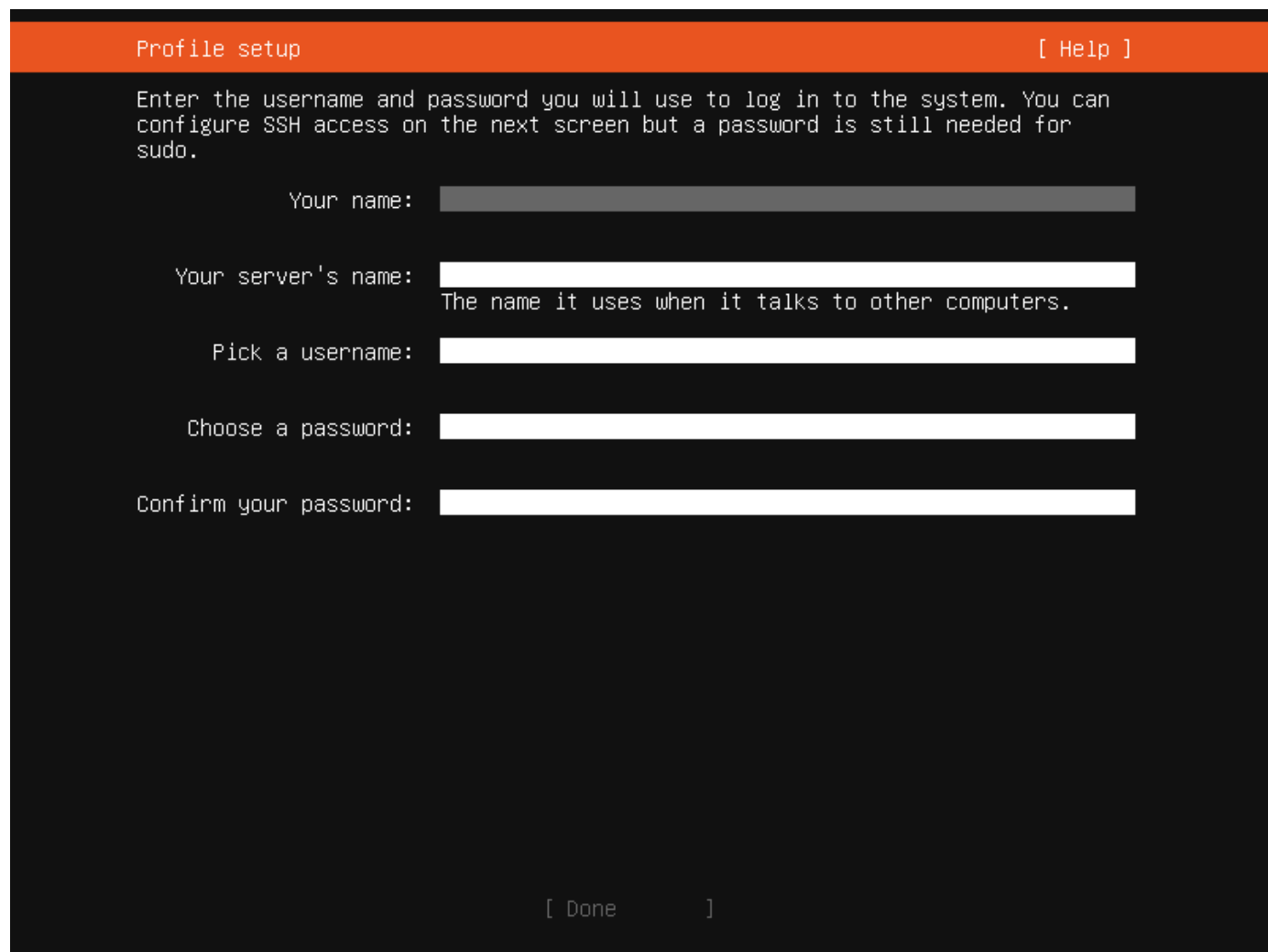

The screenshot shows a terminal window titled "Profile setup" with a "[Help]" link in the top right corner. The main text reads: "Enter the username and password you will use to log in to the system. You can configure SSH access on the next screen but a password is still needed for sudo." Below this are five input fields: "Your name:" (with a greyed-out field), "Your server's name:" (with a white field and a sub-note "The name it uses when it talks to other computers."), "Pick a username:" (with a white field), "Choose a password:" (with a white field), and "Confirm your password:" (with a white field). At the bottom center, there is a "[Done]" button.

identity800×600 2.43 KB

The default user will be an administrator, able to use `sudo` (this is why a password is needed, even if SSH public key access is enabled on the next screen).

SSH

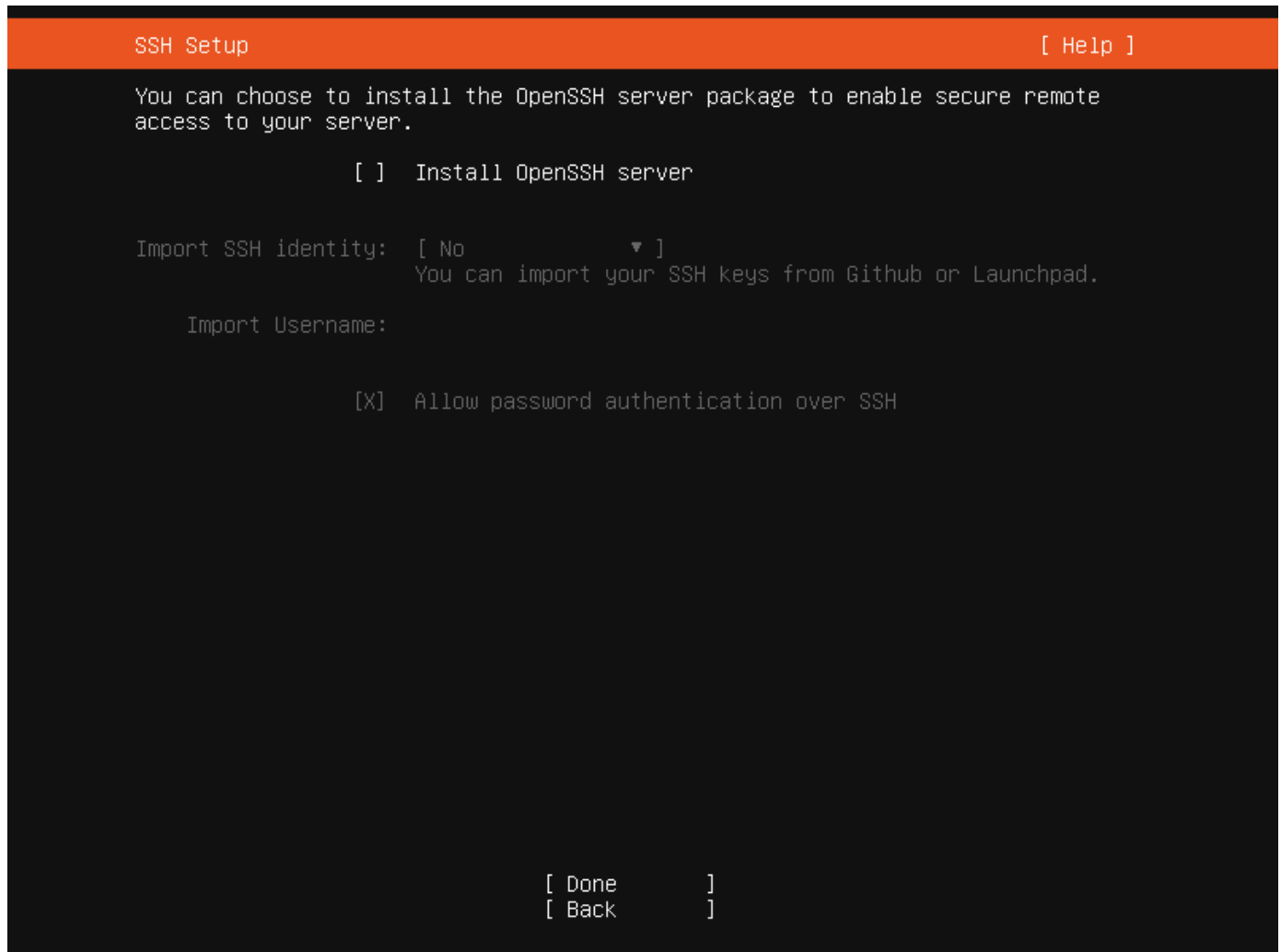

ssh800×600 2.27 KB

A default Ubuntu install has no open ports. It is very common to administer servers via SSH so the installer allows it to be installed with the click of a button.

You can import keys for the default user from GitHub or Launchpad.

If you import a key, then password authentication is disabled by default but it can be re-enabled again if you wish.

Snaps

```
Featured Server Snaps [ Help ]

These are popular snaps in server environments. Select or deselect with SPACE,
press ENTER to see more details of the package, publisher and versions
available.

[ ] microk8s          Kubernetes for workstations and appliances ▶
[ ] nextcloud        Nextcloud Server - A safe home for all your data ▶
[ ] wekan            Open-Source kanban ▶
[ ] kata-containers  Lightweight virtual machines that seamlessly plug int ▶
[ ] docker           Docker container runtime ▶
[ ] canonical-livepatch Canonical Livepatch Client ▶
[ ] rocketchat-server Group chat server for 100s, installed in seconds. ▶
[ ] mosquito        Eclipse Mosquitto MQTT broker ▶
[ ] etcd            Resilient key-value store by CoreOS ▶
[ ] powershell     PowerShell for every system! ▶
[ ] stress-ng       A tool to load, stress test and benchmark a computer ▶
[ ] sabnzbd         SABnzbd ▶
[ ] wormhole        get things from one computer to another, safely ▶
[ ] aws-cli         Universal Command Line Interface for Amazon Web Servi ▶
[ ] google-cloud-sdk Command-line interface for Google Cloud Platform prod ▶
[ ] slcli           Python based SoftLayer API Tool. ▶
[ ] doctl          DigitalOcean command line tool ▶
[ ] conjure-up      Package runtime for conjure-up spells ▶
[ ] minidlna-escoand server software with the aim of being fully compliant ▶
[ ] postgresql10   PostgreSQL is a powerful, open source object-relation ▶
[ ] heroku         CLI client for Heroku ▶
[ ] keepalived     High availability VRRP/BFD and load-balancing for Lin ▶
[ ] prometheus     The Prometheus monitoring system and time series data ▶
[ ] juju           Simple, secure and stable devops. Juju keeps complexi ▶

[ Done      ]
[ Back     ]
```

snaps800×600 9.09 KB

If a network connection is enabled, a selection of snaps that are useful in a server environment are presented and can be selected for installation.

Installation logs

```
Installing system [ Help ]

installing system
  curtin command install
    preparing for installation
    configuring storage
      running 'curtin block-meta simple'
      curtin command block-meta
        removing previous storage devices
        configuring disk: disk-vda
        configuring partition: partition-0
        configuring partition: partition-1
        configuring format: format-0
        configuring mount: mount-0
    configuring network
      running 'curtin net-meta auto'
      curtin command net-meta
    writing install sources to disk
      running 'curtin extract'
      curtin command extract
        acquiring and extracting image from cp:///media/filesystem
    configuring installed system
      running '/snap/bin/subiquity.subiquity-configure-run'
      running '/snap/bin/subiquity.subiquity-configure-apt
/snap/subiquity/1772/usr/bin/python3 true'
      curtin command apt-config
      curtin command in-target -

[ View full log ]
```

install_progress800×600 4.62 KB

The final screen of the installer shows the progress of the installer and allows viewing of the full log file. Once the install has completed and security updates installed, the installer waits for confirmation before restarting.

```
----- Finished install! -----
  running '/snap/bin/subiquity.subiquity-configure-run'
  running '/snap/bin/subiquity.subiquity-configure-apt
/snap/subiquity/1772/usr/bin/python3 true'
  curtin command apt-config
  curtin command in-target
  running 'curtin curthooks'
  curtin command curthooks
    configuring apt configuring apt
    installing missing packages
    configuring iscsi service
    configuring raid (mdadm) service
    installing kernel
    setting up swap
    apply networking config
    writing etc/fstab
    configuring multipath
    updating packages on target system
    configuring pollinate user-agent on target
    updating initramfs configuration
  finalizing installation
    running 'curtin hook'
    curtin command hook
  executing late commands
final system configuration
  configuring cloud-init
  restoring apt configuration
  downloading and installing security updates
  copying logs to installed system
```

[View full log]

[Reboot]

install_done800×600 6.64 KB

Guided options

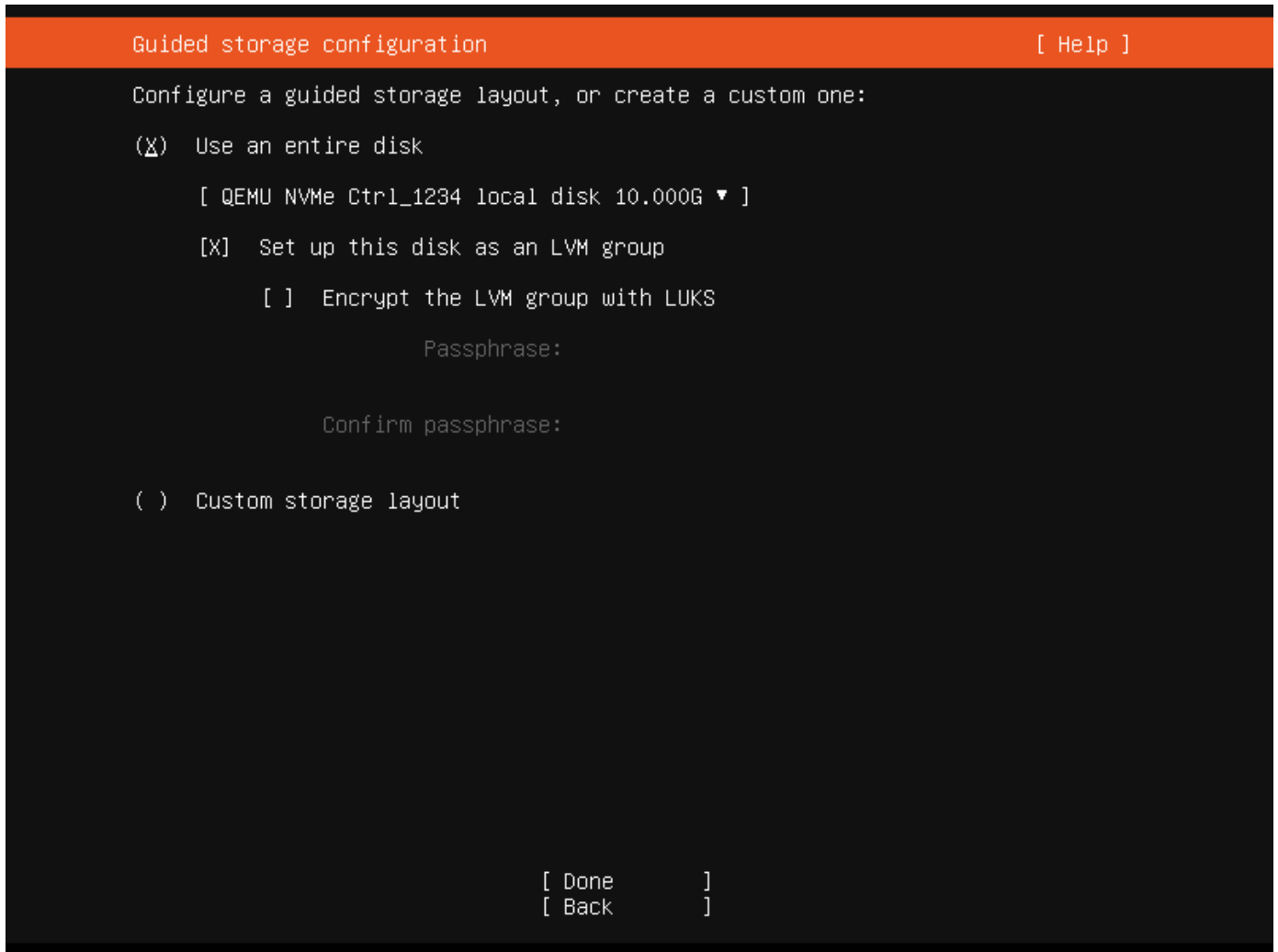

Selecting “Use an entire disk” on the Guided storage configuration screen will install Ubuntu onto the selected disk, replacing any partitions or data already there.

You can choose whether or not to set up LVM, and if you do, whether or not to encrypt the volume with LUKS. If you encrypt the volume, you need to choose a passphrase that will need to be entered each time the system boots.

If you select “Custom storage layout”, no configuration will be applied to the disks.

In either case, the installer moves onto the main storage customisation screen.

The main storage screen

```
Storage configuration [ Help ]

FILE SYSTEM SUMMARY

MOUNT POINT      SIZE      TYPE      DEVICE TYPE
[ /               8.996G   new ext4  new LVM logical volume ▶ ]
[ /boot          1.000G   new ext4  new partition of local disk ▶ ]

AVAILABLE DEVICES

DEVICE                                TYPE                                SIZE
[ QEMU NVMe Ctrl_5678                  local disk                           10.000G ▶ ]
  unused

[ Create software RAID (md) ▶ ]
[ Create volume group (LVM) ▶ ]

USED DEVICES

DEVICE                                TYPE                                SIZE
[ ubuntu-vg (new)                       LVM volume group                     8.996G ▶ ]
  ubuntu-lv    new, to be formatted as ext4, mounted at / 8.996G ▶ ]

[ QEMU NVMe Ctrl_1234                    local disk                           10.000G ▶ ]
  partition 1  new, bios_grub                                     1.000M ▶ ]
  partition 2  new, to be formatted as ext4, mounted at /boot 1.000G ▶ ]
  partition 3  new, PV of LVM volume group ubuntu-vg                8.997G ▶ ]

[ Done      ]
[ Reset     ]
[ Back      ]
```

This screen presents a summary of the current storage configuration. Each device or partition of a device corresponds to a different row (which can be selected), and pressing Enter or space while a device is selected opens a menu of actions that apply to that device.

Partitions

```
DEVICE      TYPE      SIZE
[ QEMU NVMe Ctrl_1234  local disk  10.000G ▶ ]
  unused

[ QEMU NVMe Ctrl_5678  local disk  10.000G ▶ ]
  unused

[ Create software RAID (md) ▶ ]
[ Create volume group (LVM) ▶ ]

◀ (close)
Info ▶
Reformat ▶
Add GPT Partition ▶
Format ▶
Remove from RAID/LVM
Use As Boot Device
```

To add a partition to a device, select “Add GPT Partition” for that device.

FILE SYSTEM SUMMARY

MOUNT POINT	SIZE	TYPE	DEVICE TYPE
[/	8.996G	new ext4	new LVM logical volume ▶]
[/boot	1.000G	new ext4	new partition of local disk ▶]

AVAILABLE DEVICES

Adding GPT partition to QEMU NVMe Ctrl1_5678

Size (max 9.998G):

Format: [ext4 ▼]

Mount: [/home ▼]

[Create]

[Cancel]

partition 2	new, to be formatted as ext4, mounted at /boot	1.000G ▶
partition 3	new, PV of LVM volume group ubuntu-vg	8.997G ▶

[Done]

[Reset]

[Back]

You can leave “Size” blank to use all the remaining space on the device.

RAID

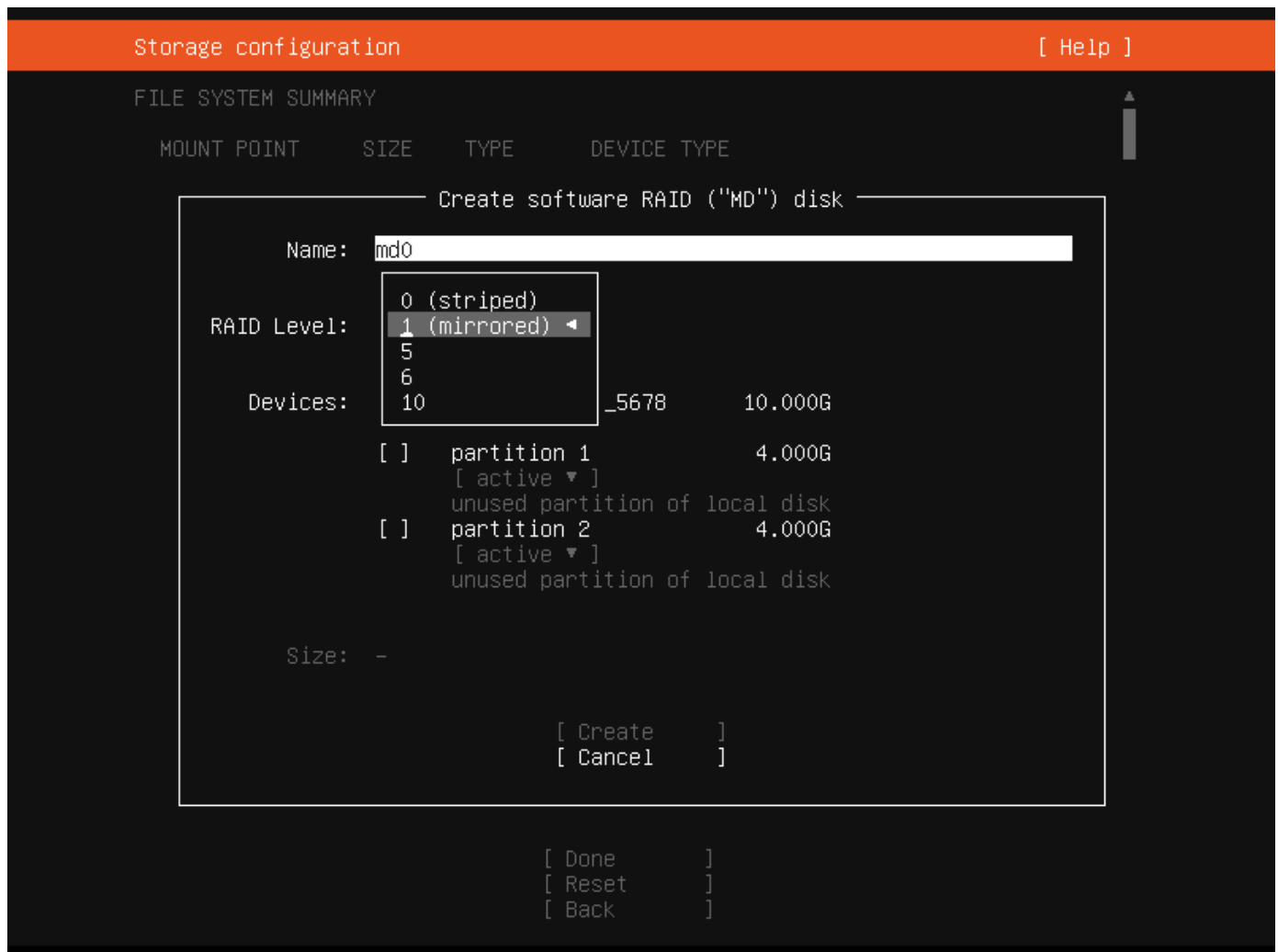

[Linux software RAID](#) (RAID stands for “Redundant Array of Inexpensive Disks”) can be used to combine several disks into a single device that is (usually) tolerant to any one disk failure.

A software RAID device can be created out of entire disks or unformatted partitions. Select the “Create software RAID (“MD”)” button to open the creation dialog.

The server installer supports creating devices with RAID level 0, 1, 5, 6 or 10. It does not allow customising other options such as metadata format or RAID10 layout at this time. See the [Linux RAID documentation](#) for more details.

A software RAID device can be formatted and mounted directly, can be partitioned into several partitions, or even be used as part of another RAID device or LVM volume group.

Logical Volume Manager (LVM)

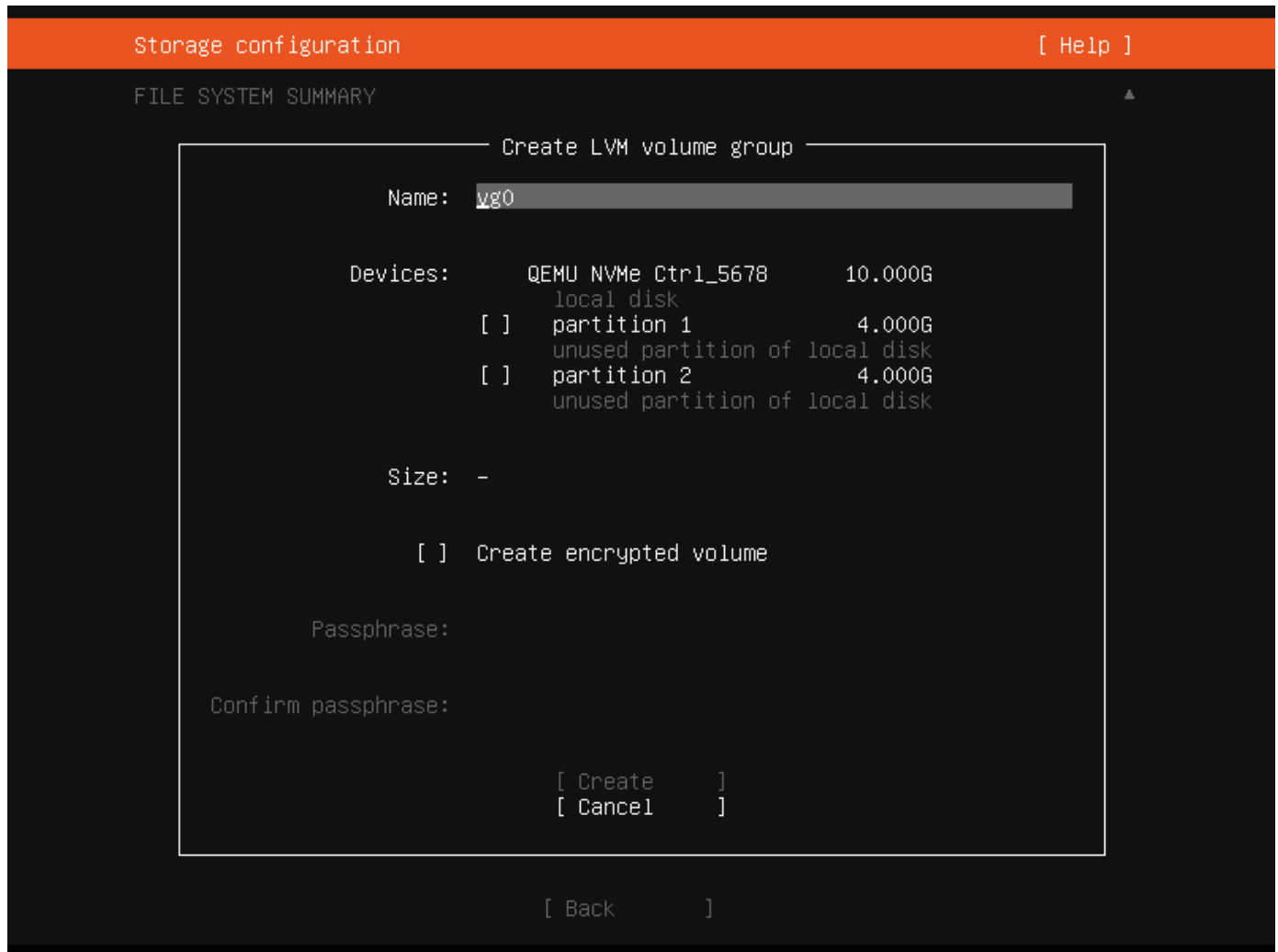

The LVM is a system of managing logical volumes, or filesystems, that is much more advanced and flexible than the traditional method of partitioning a disk into one or more segments and formatting that partition with a filesystem. It can be used to combine several disks into one larger pool of storage but it offers advantages even in a single disk system, such as snapshots and easy resizing of logical volumes.

As with RAID, a LVM volume group can be created out of entire disks or unformatted partitions. Select the “Create LVM volume group” button to open the creation dialog.

Once a volume group has been created, it can be divided into named logical volumes which can then be formatted and mounted. It generally makes sense to leave some space in the volume group for storage of snapshots and creation of more logical volumes as needed.

The server installer does not supported configuring any of the many, many options that LVM supports when creating volume groups and logical volumes.

Selecting boot devices



On all architectures other than s390x, the bootloader needs to be installed to a disk in such a way that the system firmware can find it on boot. By default, the first device to have a partition created on it is selected as a boot device

but this can be changed later.

On amd64 and arm64 systems, multiple disks can be selected as boot devices, which means a system can be configured so that it will continue to boot after a failure of any one drive (assuming the root filesystem is placed on a RAID). The bootloader will be installed to each of these drives, and the operating system configured to install new versions of GRUB to each drive as it is updated.

amd64 systems use GRUB as the bootloader. amd64 systems can boot in either UEFI or legacy (sometimes called “BIOS”) mode (many systems can be configured to boot in either mode) and the bootloader is located completely differently in the two modes.

In legacy mode, the bootloader is read from the first “sector” of a hard drive (exactly which hard drive is up to the system firmware, which can usually be configured in a vendor-specific way). The installer will write GRUB to the start of all disks selected as a boot devices. As GRUB does not entirely fit in one sector, a small unformatted partition is needed at the start of the disk, which will automatically be created when a disk is selected as a boot device (a disk with an existing GPT partition table can only be used as a boot device if it has this partition).

In UEFI mode, the bootloader loaded from a “EFI System Partition” (ESP), which is a partition with a particular type GUID. The installer automatically creates a 512MiB ESP on a disk when it is selected as a boot device and will install GRUB there (a disk with an existing partition table can only be used as a boot device if it has an ESP – bootloaders for multiple operating systems can be installed into a single ESP). UEFI defines a standard way to configure the way in which the operating system is chosen on boot, and the installer uses this to configure the system to boot the just-installed operating system. One of the ESPs must be mounted at `/boot/efi`.

Supported arm64 servers boot using UEFI, and are configured the same way as an UEFI-booting amd64 system.

ppc64el systems also load their bootloader (Petitboot, a small linux kernel) from a “PREP” partition with a special flag, so in most ways they are similar to a UEFI system. The installer only supports one PREP partition at this time.

Limitations and workarounds

Currently, the installer cannot *edit* partition tables. You can use existing partitions or reformat a drive entirely but you cannot, for example, remove a large partition and replace it with two smaller ones.

The installer allows the creation of LVM volume groups and logical volumes and MD raid devices, but does not allow tweaking of the parameters – for example, all logical volumes are linear and all MD raid devices use the default metadata format (1.2).

These limits can both be worked around in the same way: drop to a shell and use the usual shell commands to edit the partition table or create the LV or RAID with desired parameters, and then select these partitions or devices as mount points in the installer. Any changes you make while the installer is running but before altering the storage configuration will be reflected in the installer.

The installer cannot yet configure iSCSI mounts, ZFS at all, or btrfs subvolumes.

Attaching the [Ubuntu Pro](#) subscription to Ubuntu brings you the [enterprise lifecycle](#), including [Linux kernel livepatching](#), access to [FIPS-validated packages](#), and [compliance with security profiles](#) such as CIS. This is not required for [Ubuntu Pro](#) instances through public clouds such as [AWS](#), [Azure](#) or [GCP](#), since these are automatically attached from launch.

Note:

Subscriptions are not just for enterprise customers. Anyone can get a [personal subscription](#) for free on up to 5 machines, or 50 if you are an [official Ubuntu Community member](#).

The following instructions explain how to attach your subscription to your Ubuntu systems.

Step 1: Install the Ubuntu Pro Client

This step is necessary for Ubuntu Pro users or holders of personal subscriptions. If you are an Ubuntu Pro user through a public cloud offering, your subscription is already attached and you may skip these instructions.

We first need to make sure that we have the latest version of the Ubuntu Pro Client running. The package used to access the Pro Client (`pro`) is `ubuntu-advantage-tools`:

```
sudo apt update
sudo apt install ubuntu-advantage-tools
```

If you already have `ubuntu-advantage-tools` installed, this install command will upgrade the package to the latest version.

Step 2: Attach your subscription

Once you have the latest version of the Pro Client installed, you need to attach the Ubuntu Pro token to your Pro Client to gain access to the services provided under Ubuntu Pro.

First you need to retrieve your Ubuntu Pro token from the [Ubuntu Pro dashboard](#). To access your dashboard, you need an [Ubuntu One account](#). If you still need to create one, be sure to sign up using the email address used to create your subscription.

The Ubuntu One account functions as a single-sign-on (SSO), so once logged in we can go straight to the Ubuntu Pro dashboard at ubuntu.com/pro. Then click on the ‘Machines’ column in the ‘Your Paid Subscriptions’ table to reveal your token.

Now we’re ready to attach our Ubuntu Pro token to the Pro Client:

```
sudo pro attach <your_pro_token>
```

You will know that the token has been successfully attached when you see the list of services, descriptions and their enabled/disabled status in a table similar to this:

SERVICE	ENTITLED	STATUS	DESCRIPTION
esm-apps	yes	enabled	Expanded Security Maintenance for Applications
esm-infra	yes	enabled	Expanded Security Maintenance for Infrastructure
livepatch	yes	enabled	Canonical Livepatch service
realtime-kernel	yes	disabled	Ubuntu kernel with PREEMPT_RT patches integrated

Note that Extended Security Maintenance (ESM) and Livepatch will auto-enable once your token has been attached to your machine.

After attaching the Pro Client with your token you can also use the Pro Client to activate most of the Ubuntu Pro services, including Livepatch, FIPS, and the CIS Benchmark tool.

Further reading

- For more information about the Ubuntu Pro Client, you can [read our documentation](#).
- For a guided tour through the most commonly-used commands available through the Ubuntu Pro Client, [check out this tutorial](#).

We always hope, of course, that every install with the server installer succeeds. But reality doesn’t always work that way and there will sometimes be failures of various kinds. This section explains the most useful way to report any failures so that we can fix the bugs causing them, and we’ll keep the topic up to date as the installer changes.

The first thing to do is to update your Subiquity snap. Not only because we fix issues that cause failures over time but also because we’ve been working on features to make failure reporting easier.

A failure will result in a crash report being generated which bundles up all the information we need to fully diagnose a failure. These live in `/var/crash` in the installer environment, and for Ubuntu 19.10 and newer this is persisted to the install media by default (if there is space).

When an error occurs you are presented with a dialog that allows you to upload the report to the error tracker and offers options for continuing. Uploads to the error tracker are non-interactive and anonymous, so they are useful for tracking which kinds of errors are affecting most users, but they do not give us a way to ask you to help diagnose the failure.

You can create a Launchpad bug report, which does let us establish this kind of two way communication, based on the contents of a crash report by using the standard `apport-cli` tool that is part of Ubuntu. Copy the crash report to another system, run:

```
apport-cli /path/to/report.crash
```

and follow the prompts.

You can also run `apport-cli` in the installer environment by switching to a shell but `apport` won’t be able to open a browser to allow you to complete the report so you’ll have to type the URL by hand on another machine.

If you have a specific goal, but are already familiar with Ubuntu Server, our *how-to* guides have more in-depth detail than our tutorials and can be applied to a broader set of applications. They’ll help you achieve an end result but may require you to understand and adapt the steps to fit your specific requirements.

	<ul style="list-style-type: none">amd64 netboot installarm64 netboot installppc64el netboot installVirtual CDROM and Petitboot on ppc64els390x install via z/VMs390x install via LPAR
Automatic installation	<ul style="list-style-type: none">Introduction to Automated Server installerAutoinstall quickstartAutoinstall quickstart on s390xAutoinstall config file referenceAutoinstall JSON schemaIBM z/VM autoinstall on s390xIBM LPAR autoinstall on s390x
ROCK Images	<ul style="list-style-type: none">IntroductionContainer customization with DockerMulti-node configuration with Docker-Compose
Software	<ul style="list-style-type: none">Package managementUpgradeReporting bugsKernel crash dump
OpenLDAP	<ul style="list-style-type: none">IntroductionInstallationAccess controlReplicationSimple LDAP user and group managementSSL/TLSBackup and restore
Samba	<ul style="list-style-type: none">IntroductionJoining Active DirectoryNT4 domain controllerFile serverPrint serverShare access controlAppArmor profileOpenLDAP backend
Kerberos	<ul style="list-style-type: none">IntroductionKerberos serverService principalsKerberos encryption typesSecondary KDCBasic workstation authenticationKerberos with OpenLDAP backend
Network user authentication with SSSD	<ul style="list-style-type: none">IntroductionActive directoryLDAPLDAP and KerberosTroubleshooting
WireGuard VPN	<ul style="list-style-type: none">IntroductionPeer to siteIntroductionOn routerInside deviceSite to site

Alternatively, our *Tutorial* section contains step-by-step directions to help outline what Ubuntu Server is capable of while helping you achieve specific aims, such as installing the operating system or customizing software.

Take a look at our *Reference* section when you need to determine what commands are available, and how to interact with various tools.

Finally, for a better understanding of how Ubuntu Server works and how it can be used and configured, our *Explanation* section enables you to expand your knowledge of the operating system and additional software.

amd64 systems boot in either UEFI or legacy (“BIOS”) mode (many systems can be configured to boot in either mode). The precise details depend on the system firmware, but both modes usually support the “Preboot eXecution Environment” (PXE) specification, which allows the provisioning of a bootloader over the network.

The process for network booting the live server installer is similar for both modes and goes like this:

1. The to-be-installed machine boots, and is directed to network boot.
2. The DHCP/BOOTP server tells the machine its network configuration and where to get the bootloader.
3. The machine’s firmware downloads the bootloader over TFTP and executes it.
4. The bootloader downloads configuration, also over TFTP, telling it where to download the kernel, RAM Disk and kernel command line to use.
5. The RAM Disk looks at the kernel command line to learn how to configure the network and where to download the server ISO from.
6. The RAM Disk downloads the ISO and mounts it as a loop device.
7. From this point on the install follows the same path as if the ISO was on a local block device.

The difference between UEFI and legacy modes is that in UEFI mode the bootloader is an EFI executable, signed so that is accepted by Secure Boot, and in legacy mode it is `PXELINUX`. Most DHCP/BOOTP servers can be configured to serve the right bootloader to a particular machine.

Configuring DHCP/BOOTP and TFTP

There are several implementations of the DHCP/BOOTP and TFTP protocols available. This document will briefly describe how to configure `dnsmasq` to perform both of these roles.

1. Install `dnsmasq` with:

```
sudo apt install dnsmasq
```

2. Put something like this in `/etc/dnsmasq.conf.d/pxe.conf`:

```
interface=<your interface>,lo
bind-interfaces
dhcp-range=<your interface>,192.168.0.100,192.168.0.200
dhcp-boot=pxelinux.0
dhcp-match=set:efi-x86_64,option:client-arch,7
dhcp-boot=tag:efi-x86_64,bootx64.efi
enable-tftp
tftp-root=/srv/tftp
```

Note

This assumes several things about your network; read `man dnsmasq` or the default `/etc/dnsmasq.conf` for lots more options.

3. Restart `dnsmasq` with:

```
sudo systemctl restart dnsmasq.service
```

Serving the bootloaders and configuration.

We need to make this section possible to write sanely

Ideally this would be something like:

```
apt install cd-boot-images-amd64
ln -s /usr/share/cd-boot-images-amd64 /srv/tftp/boot-amd64
```

Mode-independent set up

1. Download the latest live server ISO for the release you want to install:

```
wget http://cdimage.ubuntu.com/ubuntu-server/daily-live/current/focal-live-server-amd64.iso
```

2. Mount it.

```
mount ubuntu-19.10-live-server-amd64.iso /mnt
```

3. Copy the kernel and initrd from it to where the dnsmasq serves TFTP from:

```
cp /mnt/casper/{vmlinuz,initrd} /srv/tftp/
```

Set up the files for UEFI booting

1. Copy the signed shim binary into place:

```
apt download shim-signed
dpkg-deb --fsys-tarfile shim-signed*deb | tar x ./usr/lib/shim/shimx64.efi.signed -0 > /srv/tftp/bootx64.efi
```

2. Copy the signed GRUB binary into place:

```
apt download grub-efi-amd64-signed
dpkg-deb --fsys-tarfile grub-efi-amd64-signed*deb | tar x ./usr/lib/grub/x86_64-efi-signed/grubnetx64.efi.signed -0 > /srv/tftp/grubx64.efi
```

3. GRUB also needs a font to be available over TFTP:

```
apt download grub-common
dpkg-deb --fsys-tarfile grub-common*deb | tar x ./usr/share/grub/unicode.pf2 -0 > /srv/tftp/unicode.pf2
```

4. Create /srv/tftp/grub/grub.cfg that contains:

```
set default="0"
set timeout=-1

if loadfont unicode ; then
    set gfxmode=auto
    set locale_dir=$prefix/locale
    set lang=en_US
fi
terminal_output gfxterm

set menu_color_normal=white/black
set menu_color_highlight=black/light-gray
if background_color 44,0,30; then
    clear
fi

function gfxmode {
    set gfxpayload="${1}"
    if [ "${1}" = "keep" ]; then
        set vt_handoff=vt.handoff=7
    else
        set vt_handoff=
    fi
}

set linux_gfx_mode=keep

export linux_gfx_mode

menuentry 'Ubuntu 20.04' {
    gfxmode $linux_gfx_mode
    linux /vmlinuz $vt_handoff quiet splash
    initrd /initrd
```

```
}
```

Set up the files for legacy boot

1. Download pxelinux.0 and put it into place:

```
wget http://archive.ubuntu.com/ubuntu/dists/eoan/main/installer-amd64/current/images/netboot/ubuntu-installer/amd64/pxelinux.0
mkdir -p /srv/tftp
mv pxelinux.0 /srv/tftp/
```

5. Make sure to have installed package syslinux-common and then:

```
cp /usr/lib/syslinux/modules/bios/ldlinux.c32 /srv/tftp/
```

6. Create /srv/tftp/pxelinux.cfg/default containing:

```
DEFAULT install
LABEL install
    KERNEL vmlinuz
    INITRD initrd
APPEND root=/dev/ram0 ramdisk_size=1500000 ip=dhcp url=http://cdimage.ubuntu.com/ubuntu-server/daily-live/current/focal-live-server-amd64.iso
```

As you can see, this downloads the ISO from Ubuntu's servers. You may well want to host it somewhere on your infrastructure and change the URL to match.

This configuration is obviously very simple. PXELINUX has many, many options, and you can consult its documentation at <https://wiki.syslinux.org/wiki/index.php?title=PXELINUX> for more.

This document provides the steps needed to install an system via netbooting and subiquity in UEFI mode with Ubuntu 20.04 (or later). The process is applicable to both of the architectures, arm64 and amd64. This process is inspired by [this Ubuntu Discourse post](#) for *legacy mode*, which is UEFI's predecessor. Focal (20.04, 20.04.5) and Groovy (20.10) have been tested with the following method.

Configuring TFTP

This article assumes that you have setup your tftp (and/or DHCP/bootp if necessary, depending on your LAN configuration) by following [this Ubuntu Discourse post](#), or you could also consider build your own tftp in this way if your DNS and DHCP is already well configured:

```
$ sudo apt install tftpd-hpa
```

If the installation is successful, check the corresponding TFTP service is active by this command:

```
$ systemctl status tftpd-hpa.service
```

It is expected to show *active (running)* from the output messages. We will also assume your tftp root path is /var/lib/tftpboot in the remaining of this article.

Serving Files

You can skip the whole section of the following manual setup instruction by using [this non-official tool](#). The tool will setup your TFTP server to serve necessary files for netbooting.

Necessary Files

There are several files needed for this process. The following files are needed:

- Ubuntu live server image
 - For arm64 architecture, its image name has a *-arm64* suffix. For example, *ubuntu-20.04.5-live-server-arm64.iso*.
 - For amd64 architecture, its image name has a *-amd64* suffix. For example, *ubuntu-20.04.5-live-server-amd64.iso*.
- grub efi binary (and the corresponding grub.cfg, which is a txt file)
 - For arm64 architecture, it is *grubnetaa64.efi.signed*.
 - For amd64 architecture, it is *grubnetx64.efi.signed*.
- initrd extracted from your target Ubuntu live server image (use *hwe-initrd* instead if you want to boot with HWE kernel)

- `vmlinuz` extracted from your target Ubuntu live server image (use `hwe-vmlinuz` instead if you want to boot with HWE kernel)

Examples

In the following sections, we will take arm64 image as an example. This means the following files are used:

- Ubuntu 20.04.5 live server image `ubuntu-20.04.5-live-server-arm64.iso` from <https://cdimage.ubuntu.com/ubuntu/releases/20.04.5/release/ubuntu-20.04.5-live-server-arm64.iso>
- grub efi binary `grubnetaa64.efi.signed` from <http://ports.ubuntu.com/ubuntu-ports/dists/focal/main/uefi/grub2-arm64/current/grubnetaa64.efi.signed>
- `initrd` extracted from `ubuntu-20.04.5-live-server-arm64.iso`
- `vmlinuz` extracted from `ubuntu-20.04.5-live-server-arm64.iso`

Please replace the corresponding files when you want to work on amd64 image. For example, your files may be:

- Ubuntu 20.04.5 live server image `ubuntu-20.04.5-live-server-amd64.iso` from <https://releases.ubuntu.com/20.04.5/ubuntu-20.04.5-live-server-amd64.iso>
- grub efi binary `grubnetx64.efi.signed` from <http://archive.ubuntu.com/ubuntu/dists/focal/main/uefi/grub2-amd64/current/grubnetx64.efi.signed>
- `initrd` extracted from `ubuntu-20.04.5-live-server-amd64.iso`
- `vmlinuz` extracted from `ubuntu-20.04.5-live-server-amd64.iso`

Download and Serve Grub EFI Binary

The grub binary helps us redirect the downloading path to the target files via `grub.cfg`. You may refer to [this discourse post](#) to get more information about the PXE process and why we need this binary.

```
$ sudo wget http://ports.ubuntu.com/ubuntu-ports/dists/focal/main/uefi/grub2-arm64/current/grubnetaa64.efi.signed -O /var/lib/tftpboot/grubnetaa64.efi.signed
```

Please note you may need to change **the archive dists name** from `focal` to your target distribution name.

Download and Serve More Files

Fetch the installer by downloading a Ubuntu arm server iso, e.g. [20.04.5 live server arm64 iso](#). Please note the prefix `live` is significant. We will need the files available only in the live version.

Mount the iso and copy the target files we need to the TFTP folder

```
$ sudo mount ./ubuntu-20.04.5-live-server-arm64.iso /mnt
$ sudo mkdir /var/lib/tftpboot/grub /var/lib/tftpboot/casper
$ sudo cp /mnt/boot/grub/grub.cfg /var/lib/tftpboot/grub/
$ sudo cp /mnt/casper/initrd /var/lib/tftpboot/casper/
$ sudo cp /mnt/casper/vmlinuz /var/lib/tftpboot/casper/
```

So, the TFTP root folder should look like this now:

```
$ find /var/lib/tftpboot/
/var/lib/tftpboot/
/var/lib/tftpboot/grub
/var/lib/tftpboot/grub/grub.cfg
/var/lib/tftpboot/grubnetaa64.efi.signed
/var/lib/tftpboot/casper
/var/lib/tftpboot/casper/initrd
/var/lib/tftpboot/casper/vmlinuz
```

Finally, let's customize the grub menu so we could install our target image by fetching it directly over the internet.

```
$ sudo chmod +w /var/lib/tftpboot/grub/grub.cfg
$ sudo vi /var/lib/tftpboot/grub/grub.cfg
```

Add an new entry

```
menuentry "Install Ubuntu Server (Focal 20.04.5) (Pull the iso from web)" {
    set gfxpayload=keep
    linux /casper/vmlinuz url=http://cdimage.ubuntu.com/ubuntu/releases/20.04.5/release/ubuntu-20.04.5-live-server-arm64.iso only-ubiquity ip=dhcp ---
    initrd /casper/initrd
}
```

ip=dhcp is for the dhcp management setup in the lab. *url* is used to point to your target image download url. Remember to change them according to your scenario.

If everything goes well, you should get into the expected grub menu of the ephemeral live prompt. Select the entry you just put in *grub.cfg*, which is *Install Ubuntu Server (Focal 20.04.5) (Pull the iso from web)* in our example. Waiting a bit for downloading the iso and then you will see the subiquity welcome message. Enjoy the installation!

Appendix

Always Make Sure of the Serving File Names

For example, please make sure the target file name for *linux* and *initrd* is correct. For example, the default *initrd* binary file name of 20.04.5 is *initrd*, and it is *initrd.lz* for 20.10. Always make sure you serve the right file names. This is a frequent troubleshooting issue. Pay attention on this detail could save a lot of your time.

Booting Screenshots

If your setup is correct, your *grub.cfg* should redirect the process to an ephemeral environment to download your target image assigned in the grub entry of *grub.cfg*. You will see a screen like this if you are able to access console or monitor device of your target machine:

```
Listening on LPF/ens3/02:56:e6:08:2d:e3
Sending on LPF/ens3/02:56:e6:08:2d:e3
Sending on Socket/fallback
DHCPDISCOVER on ens3 to 255.255.255.255 port 67 interval 3 (xid=0x83e74430)
DHCPOFFER of 10.228.68.73 from 10.228.68.5
DHCPREQUEST for 10.228.68.73 on ens3 to 255.255.255.255 port 67 (xid=0x3044e783)
DHCPOACK of 10.228.68.73 from 10.228.68.5 (xid=0x83e74430)
bound to 10.228.68.73 -- renewal in 286 seconds.
Connecting to 10.228.68.91 (10.228.68.91:80)
ubuntu-20.04.1-live- 0% | 462k 0:34:48 ETA
ubuntu-20.04.1-live- 2% | 22.2M 0:01:20 ETA
ubuntu-20.04.1-live- 4% * | 39.7M 0:01:05 ETA
ubuntu-20.04.1-live- 6% ** | 59.6M 0:00:57 ETA
ubuntu-20.04.1-live- 8% *** | 77.7M 0:00:53 ETA
ubuntu-20.04.1-live- 10% **** | 97.7M 0:00:50 ETA
ubuntu-20.04.1-live- 12% ***** | 114M 0:00:49 ETA
ubuntu-20.04.1-live- 14% **** | 132M 0:00:47 ETA
ubuntu-20.04.1-live- 16% ***** | 149M 0:00:45 ETA
ubuntu-20.04.1-live- 18% ***** | 166M 0:00:45 ETA
ubuntu-20.04.1-live- 20% ***** | 183M 0:00:43 ETA
ubuntu-20.04.1-live- 21% ***** | 200M 0:00:42 ETA
ubuntu-20.04.1-live- 23% ***** | 214M 0:00:42 ETA
```

Wait a bit to complete downloading. If you see this subiquity welcome page, the installer is successfully launched via your UEFI PXE setup. Configurations!!

```
Willkommen! Bienvenue! Welcome! Добро пожаловать! Welkom! [ Help ]
Use UP, DOWN and ENTER keys to select your language.
[ Asturianu ]
[ Bahasa Indonesia ]
[ Català ]
[ Deutsch ]
[ English ]
[ English (UK) ]
[ Español ]
[ Français ]
[ Hrvatski ]
[ Latviski ]
[ Lietuviškai ]
[ Magyar ]
[ Nederlands ]
[ Norsk bokmål ]
[ Polski ]
[ Suomi ]
[ Svenska ]
[ Čeština ]
[ Ελληνικά ]
[ Беларуская ]
[ Русский ]
[ Српски ]
[ Українська ]
```

- Open a terminal window on your workstation and make sure the 'ipmitool' package is installed.

- Verify if you can reach the BMC of the IBM Power system via ipmitool with a simple ipmitool call like:

```
$ ipmitool -I lanplus -H Power9Box -U <user> -P <password> power status
Chassis Power is off
```

or:

```
$ ipmitool -I lanplus -H Power9Box -U <user> -P <password> fru print 47
Product Name      : OpenPOWER Firmware
Product Version   : open-power-SUPERMICRO-P9DSU-V2.12-20190404-prod
Product Extra     : op-build-lb9269e
Product Extra     : buildroot-2018.11.3-12-g222837a
Product Extra     : skiboot-v6.0.19
Product Extra     : hostboot-c00d44a-pb1307d7
Product Extra     : occ-8fa3854
Product Extra     : linux-4.19.30-openpower1-p22d1df8
Product Extra     : petitboot-v1.7.5-p8f5fc86
```

or:

```
$ ipmitool -I lanplus -H Power9Box -U <user> -P <password> sol info
Set in progress   : set-complete
Enabled           : true
Force Encryption  : false
Force Authentication : false
Privilege Level   : OPERATOR
Character Accumulate Level (ms) : 0
Character Send Threshold : 0
Retry Count       : 0
Retry Interval (ms) : 0
Volatile Bit Rate (kbps) : 115.2
Non-Volatile Bit Rate (kbps) : 115.2
Payload Channel   : 1 (0x01)
Payload Port      : 623
```

- Open a second terminal and activate serial-over-LAN (sol), so that you have two terminal windows open:
 1. to control the BMC via IPMI
 2. for the serial-over-LAN console

- Activate serial-over-LAN:

```
$ ipmitool -I lanplus -H Power9Box -U <user> -P <password> sol activate
...
```

- And power the system on in the 'control terminal' and watch the sol console:

```
$ ipmitool -I lanplus -H Power9Box -U <user> -P <password> power on
...
```

It takes some time to see the first lines in the sol console:

```
[SOL Session operational. Use ~? for help]
---= Welcome to Hostboot ==--
```

```
2.77131|secure|SecureROM valid - enabling functionality
3.15860|secure|Booting in secure mode.
5.59684|Booting from SBE side 0 on master proc=00050000
5.60502|ISTEP 6. 5 - host_init_fsi
5.87228|ISTEP 6. 6 - host_set_ipl_parms
6.11032|ISTEP 6. 7 - host_discover_targets
6.67868|HWAS|PRESENT> DIMM[03]=A0A0000000000000
6.67870|HWAS|PRESENT> Proc[05]=8800000000000000
6.67871|HWAS|PRESENT> Core[07]=3FFF0C33FFC30000
6.98988|ISTEP 6. 8 - host_update_master_tpm
7.22711|SECURE|Security Access Bit> 0xC000000000000000
7.22711|SECURE|Secure Mode Disable (via Jumper)> 0x0000000000000000
7.22731|ISTEP 6. 9 - host_gard
7.43353|HWAS|FUNCTIONAL> DIMM[03]=A0A0000000000000
```

```
7.43354|HWAS|FUNCTIONAL> Proc[05]=8800000000000000
7.43356|HWAS|FUNCTIONAL> Core[07]=3FFF0C33FFC30000
7.44509|ISTEP 6.10 - host_revert_sbe_mcs_setup
```

...

- After a moment the system reaches the Petitboot screen:

```
Petitboot (v1.7.5-p8f5fc86) 9006-12P 1302NXA
```

```
[Network: enP2p1s0f0 / 0c:c4:7a:87:04:d8]
  Execute
  netboot enP2p1s0f0 (pxelinux.0)
[CD/DVD: sr0 / 2019-10-17-13-35-12-00]
  Install Ubuntu Server
[Disk: sda2 / 295f571b-b731-4ebb-b752-60aad80fc1b]
  Ubuntu, with Linux 5.4.0-14-generic (recovery mode)
  Ubuntu, with Linux 5.4.0-14-generic
  Ubuntu
```

```
System information
System configuration
System status log
Language
Rescan devices
Retrieve config from URL
Plugins (0)
```

```
*Exit to shell
```

Enter=accept, e=edit, n=new, x=exit, l=language, g=log, h=help

Select '*Exit to shell'

Notice:

Make sure you really watch the sol, since the petitboot screen (above) has a time out (usually 10 or 30 seconds) and afterwards it automatically proceeds and it tries to boot from the configured devices (usually disk). This can be prevented by just navigating in petitboot.

The petitboot shell is small Linux based OS:

...

Exiting petitboot. Type 'exit' to return.
You may run 'pb-sos' to gather diagnostic data

Notice:

In case one needs to gather system details and diagnostic data for IBM support, this can be done here by running 'pb-sos' (see msg).

- Now download the 'live-server' ISO image (notice that 'focal-live-server-ppc64el.iso' uses subiquity, 'focal-server-s390x.iso' uses d-i):

Again for certain web locations a proxy needs to be used:

```
/ # export http_proxy=http://squid.proxy:3128 # in case a proxy is required
/ #
/ # wget http://cdimage.ubuntu.com/ubuntu-server/daily-live/current/focal-live-server-ppc64el.iso
Connecting to <proxy-ip>:3128 (<proxy-ip>:3128)
focal-live-server-pp 100% |.....| 922M 0:00:00 ETA
```

- Next is to loop-back mount the ISO:

```
/ # mkdir iso
/ # mount -o loop focal-live-server-ppc64el.iso iso
```

Or in case autodetect of type iso9660 is not supported or not working, explicitly specify the 'iso9660' type:

```
/ # mount -t iso9660 -o loop focal-live-server-ppc64el.iso iso
```

- Now load kernel and initrd from the loop-back mount, specify any needed kernel parameters and get it going:

```
/ # kexec -l ./iso/casper/vmlinuz --initrd=./iso/casper/initrd.gz --append="ip=dhcp url=http://cdimage.ubuntu.com/server/daily-live/current/focal-live-server-ppc64el.iso http_proxy=http://squid.proxy:3128 --- quiet"
```

```

/ # kexec -e
The system is going down NOW!
Sent SIGTERM to all processes
Sent SIGKILL to all processes
...

```

Note that in order to boot with and install the hwe kernel (if available), just substitute vmlinux with vmlinux-hwe in the first kexec line.

- The system now performs the initial boot of the installer:

```

[ 1200.687004] kexec_core: Starting new kernel
[ 1277.493883374,5] OPAL: Switch to big-endian OS
[ 1280.465061219,5] OPAL: Switch to little-endian OS
ln: /tmp/mountroot-fail-hooks.d//scripts/init-premount/lvm2: No such file or directory
Internet Systems Consortium DHCP Client 4.4.1
Copyright 2004-2018 Internet Systems Consortium.
All rights reserved.
For info, please visit https://www.isc.org/software/dhcp/
Listening on LPF/enP2p1s0f3/0c:c4:7a:87:04:db
Sending on LPF/enP2p1s0f3/0c:c4:7a:87:04:db
Listening on LPF/enP2p1s0f2/0c:c4:7a:87:04:da
Sending on LPF/enP2p1s0f2/0c:c4:7a:87:04:da
Listening on LPF/enP2p1s0f1/0c:c4:7a:87:04:d9
Sending on LPF/enP2p1s0f1/0c:c4:7a:87:04:d9
Listening on LPF/enP2p1s0f0/0c:c4:7a:87:04:d8
Sending on LPF/enP2p1s0f0/0c:c4:7a:87:04:d8
Sending on Socket/fallback
DHCPDISCOVER on enP2p1s0f3 to 255.255.255.255 port 67 interval 3
(xid=0x8d5704c)
DHCPDISCOVER on enP2p1s0f2 to 255.255.255.255 port 67 interval 3
(xid=0x94b25b28)
DHCPDISCOVER on enP2p1s0f1 to 255.255.255.255 port 67 interval 3
(xid=0x4edd0558)
DHCPDISCOVER on enP2p1s0f0 to 255.255.255.255 port 67 interval 3
(xid=0x61c90d28)
DHCPOFFER of 10.245.71.102 from 10.245.71.3
DHCPREQUEST for 10.245.71.102 on enP2p1s0f0 to 255.255.255.255 port 67
(xid=0x280dc961)
DHCPACK of 10.245.71.102 from 10.245.71.3 (xid=0x61c90d28)
bound to 10.245.71.102 -- renewal in 236 seconds.
Connecting to 91.189.89.11:3128 (91.189.89.11:3128)
focal-live-server-pp 1% | | 14.0M 0:01:04 ETA
focal-live-server-pp 4% |* | 45.1M 0:00:38 ETA
focal-live-server-pp 8% |** | 76.7M 0:00:33 ETA
focal-live-server-pp 11% |*** | 105M 0:00:31 ETA
focal-live-server-pp 14% |**** | 133M 0:00:29 ETA
focal-live-server-pp 17% |***** | 163M 0:00:27 ETA
focal-live-server-pp 20% |***** | 190M 0:00:26 ETA
focal-live-server-pp 24% |***** | 222M 0:00:25 ETA
focal-live-server-pp 27% |***** | 253M 0:00:23 ETA
focal-live-server-pp 30% |***** | 283M 0:00:22 ETA
focal-live-server-pp 34% |***** | 315M 0:00:21 ETA
focal-live-server-pp 37% |***** | 343M 0:00:20 ETA
focal-live-server-pp 39% |***** | 367M 0:00:19 ETA
focal-live-server-pp 42% |***** | 392M 0:00:18 ETA
focal-live-server-pp 45% |***** | 420M 0:00:17 ETA
focal-live-server-pp 48% |***** | 451M 0:00:16 ETA
focal-live-server-pp 52% |***** | 482M 0:00:15 ETA
focal-live-server-pp 55% |***** | 514M 0:00:14 ETA
focal-live-server-pp 59% |***** | 546M 0:00:13 ETA
focal-live-server-pp 62% |***** | 578M 0:00:11 ETA
focal-live-server-pp 65% |***** | 607M 0:00:10 ETA
focal-live-server-pp 69% |***** | 637M 0:00:09 ETA

```

```

focal-live-server-pp 72% |*****| 669M 0:00:08 ETA
focal-live-server-pp 75% |*****| 700M 0:00:07 ETA
focal-live-server-pp 79% |*****| 729M 0:00:06 ETA
focal-live-server-pp 82% |*****| 758M 0:00:05 ETA
focal-live-server-pp 85% |*****| 789M 0:00:04 ETA
focal-live-server-pp 88% |*****| 817M 0:00:03 ETA
focal-live-server-pp 91% |*****| 842M 0:00:02 ETA
focal-live-server-pp 93% |*****| 867M 0:00:01 ETA
focal-live-server-pp 97% |*****| 897M 0:00:00 ETA
focal-live-server-pp 100% |*****| 922M 0:00:00 ETA
mount: mounting /cow on /root/cow failed: No such file or directory
Connecting to plymouth: Connection refused
passwd: password expiry information changed.
[ 47.202736] /dev/loop3: Can't open blockdev
[ 52.672550] cloud-init[3759]: Cloud-init v. 20.1-10-g71af48df-0ubuntu1 running
'init-local' at Wed, 18 Mar 2020 15:18:07 +0000. Up 51.87 seconds.
...

```

- And you will eventually reach the initial subiquity installer screen:

```

Willkommen! Bienvenue! Welcome! Добро пожаловать! Welkom

```

```

Use UP, DOWN and ENTER keys to select your language.

```

```

[ English > ]
[ Asturianu > ]
[ Català > ]
[ Hrvatski > ]
[ Nederlands > ]
[ Suomi > ]
[ Français > ]
[ Deutsch > ]
[ Ελληνικά > ]
[ Magyar > ]
[ Latviešu > ]
[ Norsk bokmål > ]
[ Polski > ]
[ Русский > ]
[ Español > ]
[ Українська > ]

```

* The rest is (subiquity-) installation as usual...

There is also documentation on [booting the installer over the network](#).

- *Notice:*

Not all IBM Power machines come with the capability to install via a virtual CDROM !

- A separate system (ideally in the same network, because of ipmitool) is needed to host the ppc64el ISO Image file, that is later used as virtual CDROM.
- Login to this separate host and make sure that the ipmitool package is installed:

```
$ sudo apt install ipmitool
```

as well as Samba:

```
$ sudo apt install samba
```

- Next is to setup and configure Samba:

```

$ sudo touch /etc/samba/smb.conf && sudo tee -a /etc/samba/smb.conf <<EOF
[winshare]
  path=/var/winshare
  browseable = yes
  read only = no
  guest ok = yes

```

EOF

And do a quick verification that the required lines are in:

```
$ tail -n 5 /etc/samba/smb.conf
[winshare]
  path=/var/winshare
  browseable = yes
  read only = no
  guest ok = yes
```

- (Optional)

For downloading the image you may have to use a proxy server:

```
$ sudo touch ~/.wgetrc && sudo tee -a ~/.wgetrc <<EOF
use_proxy=yes
http_proxy=squid.proxy:3128
https_proxy=squid.proxy:3128
EOF
```

- The ISO image needs to be downloaded now:

```
$ wget http://cdimage.ubuntu.com/ubuntu/releases/focal/release/ubuntu-20.04-live-server-ppc64el.iso --
directory-prefix=/var/winshare
```

The proxy can also be passed over as wget argument, like this:

```
$ wget -e use_proxy=yes -e http_proxy=squid.proxy:3128 http://cdimage.ubuntu.com/ubuntu/releases/focal/release/ubu
20.04-live-server-ppc64el.iso --directory-prefix=/var/winshare
```

- Change file mode of the ISO image file:

```
$ sudo chmod -R 755 /var/winshare/
$ ls -l /var/winshare/
-rwxr-xr-x 1 ubuntu ubuntu 972500992 Mar 23 08:02 focal-live-server-ppc64el.iso
```

- Restart and check the Samba service:

```
$ sudo service smbd restart
$ sudo service smbd status
● smbd.service - Samba SMB Daemon
   Loaded: loaded (/lib/systemd/system/smbd.service; enabled; vendor
   preset: ena
   Active: active (running) since Tue 2020-02-04 15:17:12 UTC; 4s ago
     Docs: man:smbd(8)
           man:samba(7)
           man:smb.conf(5)
  Main PID: 6198 (smbd)
   Status: "smbd: ready to serve connections..."
     Tasks: 4 (limit: 19660)
    CGroup: /system.slice/smbd.service
            └─6198 /usr/sbin/smbd --foreground --no-process-group
            └─6214 /usr/sbin/smbd --foreground --no-process-group
            └─6215 /usr/sbin/smbd --foreground --no-process-group
            └─6220 /usr/sbin/smbd --foreground --no-process-group
Feb 04 15:17:12 host systemd[1]: Starting Samba SMB Daemon...
Feb 04 15:17:12 host systemd[1]: Started Samba SMB Daemon.
```

- Test Samba share:

```
ubuntu@host:~$ smbclient -L localhost
WARNING: The "syslog" option is deprecated
Enter WORKGROUP\ubuntu's password:
  Sharename      Type            Comment
  -----
  print$         Disk            Printer Drivers
  winshare       Disk
  IPC$           IPC             IPC Service (host server (Samba, Ubuntu))
Reconnecting with SMB1 for workgroup listing.
Server           Comment
```

```

-----
Workgroup          Master
-----
WORKGROUP         host

```

- Get the IP address of the Samba host:

```

$ ip -4 -brief address show
lo                UNKNOWN        127.0.0.1/8
ibmveth2          UNKNOWN        10.245.246.42/24

```

- (Optional)

Even more testing if the Samba share is accessible from remote:

```

user@workstation:~$ mkdir -p /tmp/test
user@workstation:~$ sudo mount -t cifs -o
username=guest,password=guest //10.245.246.42/winshare /tmp/test/
user@workstation:~$ ls -la /tmp/test/
total 1014784
drwxr-xr-x  2 root root          0 May  4 15:46 .
drwxrwxrwt 18 root root        420 May  4 19:25 ..
-rwxr-xr-x  1 root root 1038249984 May  3 19:37 ubuntu-20.04-live-server-ppc64el.iso

```

- Now use a browser and navigate to the BMC of the Power system that should be installed (let's assume the BMC's IP address is 10.245.246.247):

```
firefox http://10.245.246.247/
```

- Login to the BMC and find and select:

```
Virtual Media --> CDROM
```

- Enter the IP address of the Samba share:

```
10.245.246.42
```

and the path to the Samba share:

```
\winshare\focal-live-server-ppc64el.iso
```

- Click Save and Mount

(make sure that the virtual CDROM is really properly mounted !)

CD-ROM Image:

This option allows you to share a CD-ROM image over a Windows Share with a maximum size of 4.7GB. This image will be emulated to the host as USB device.

```

Device 1  There is an iso file mounted.
Device 2  No disk emulation set.
Device 3  No disk emulation set.
<Refresh Status>

```

```

Share host: 10.245.246.42
Path to image: \winshare\focal-live-server-ppc64el.iso
User (optional):
Password (optional):
<Save> <Mount> <Unmount>

```

- *Notice:*

It's important that you see a status like:

```
Device 1 There is an iso file mounted
```

Only in this case the virtual CDROM is properly mounted and you will see the boot / install from CDROM entry in petitboot:

```

[CD/DVD: sr0 / 2020-03-23-08-02-42-00]
  Install Ubuntu Server

```

- Now use the ipmitool to boot the system into the petitboot loader:

```

$ ipmitool -I lanplus -H 10.245.246.247 -U ADMIN -P <password> power status
$ ipmitool -I lanplus -H 10.245.246.247 -U ADMIN -P <password> sol activate
$ ipmitool -I lanplus -H 10.245.246.247 -U ADMIN -P <password> power on

```

Chassis Power Control: Up/On

- And reach the Petitboot screen:

Petitboot (v1.7.5-p8f5fc86)

9006-12C B0S0026

```
[Network: enP2p1s0f0 / ac:1f:6b:09:c0:52]
execute
netboot enP2p1s0f0 (pxelinux.0)
```

```
System information
System configuration
System status log
Language
Rescan devices
Retrieve config from URL
*Plugins (0)
Exit to shell
```

```
Enter=accept, e=edit, n=new, x=exit, l=language, g=log, h=help
Default boot cancelled
```

- And make sure that booting from CDROM is enabled:

Petitboot (v1.7.5-p8f5fc86)

9006-12C B0S0026

```
[Network: enP2p1s0f0 / ac:1f:6b:09:c0:52]
Execute
netboot enP2p1s0f0 (pxelinux.0)
[Disk: sda2 / ebdb022b-96b2-4f4f-ae63-69300ded13f4]
Ubuntu, with Linux 5.4.0-12-generic (recovery mode)
Ubuntu, with Linux 5.4.0-12-generic
Ubuntu
```

```
System information
System configuration
System status log
Language
Rescan devices
Retrieve config from URL
*Plugins (0)
Exit to shell
```

```
Enter=accept, e=edit, n=new, x=exit, l=language, g=log, h=help
[sda3] Processing new Disk device
```

Petitboot System Configuration

```
Autoboot:      ( ) Disabled
               (*) Enabled
```

```
Boot Order:   (0) Any CD/DVD device
               (1) disk: sda2 [uuid: ebdb022b-96b2-4f4f-ae63-69300ded13f4]
               (2) net:  enP2p1s0f0 [mac: ac:1f:6b:09:c0:52]
```

```
[   Add Device   ]
[ Clear & Boot Any ]
[       Clear    ]
```

```
Timeout:      30    seconds
```

Doing a manual live installation as described here - meaning without specifying a parmfile - is supported since Ubuntu Server LTS 20.04.5 ('Focal') and any newer release, like 20.10 ('Groovy').

The following guide assumes that a z/VM guest has been defined, and that it is able to either reach the public `cdimage.ubuntu.com` server or an internal FTP or HTTP server that hosts an Ubuntu Server 20.04 installer image, like this 20.04 (a.k.a. Focal) daily live image here: <http://cdimage.ubuntu.com/ubuntu/releases/20.04.5/release/ubuntu-20.04.5-live-server-s390x.iso>

- Find a place to download the installer image:

```
user@workstation:~$ wget
http://cdimage.ubuntu.com/ubuntu/releases/20.04.5/release/ubuntu-20.04.5-live-server-s390x.iso
--2020-08-08 16:01:52--
http://cdimage.ubuntu.com/ubuntu/releases/20.04.5/release/ubuntu-20.04.5-live-server-s390x.iso
Resolving cdimage.ubuntu.com (cdimage.ubuntu.com)... 2001:67c:1560:8001::1d, 2001:67c:1360:8001::27, 2001:67c:1360:8001::1
Connecting to cdimage.ubuntu.com
(cdimage.ubuntu.com)|2001:67c:1560:8001::1d|:80... connected.
HTTP request sent, awaiting response... 200 OK
Length: 705628160 (673M) [application/x-iso9660-image]
Saving to: 'ubuntu-20.04.5-live-server-s390x.iso'

ubuntu-20.04.5-live 100%[=====] 672.94M  37.1MB/s   in
17s

2020-08-08 16:02:10 (38.8 MB/s) - 'ubuntu-20.04.5-live-server-s390x.iso' saved
[705628160/705628160]
```

- Now loop-back mount the ISO to extract four files that are needed for a z/VM guest installation:

```
user@workstation:~$ mkdir iso
user@workstation:~$ sudo mount -o loop ubuntu-20.04.5-live-server-s390x.iso iso
user@workstation:~$

user@workstation:~$ ls -l ./iso/boot/{ubuntu.exec,parmfile.*,kernel.u*,initrd.u*}
./iso/boot/initrd.ubuntu
./iso/boot/kernel.ubuntu
./iso/boot/parmfile.ubuntu
./iso/boot/ubuntu.exec
```

- Now transfer these four files to your z/VM guest (for example to its 'A' file mode), using either the 3270 terminal emulator or ftp.
- Then log on to your z/VM guest that you want to use for the installation. In this example it will be guest '10.222.111.24'.
- Execute the ubuntu REXX script to kick-off the installation:

```
ubuntu
00: 0000004 FILES PURGED
00: RDR FILE 0125 SENT FROM 10.222.111.24 PUN WAS 0125 RECS 101K CPY 001 A NOHOLD NO
KEEP
00: RDR FILE 0129 SENT FROM 10.222.111.24 PUN WAS 0129 RECS 0001 CPY 001 A NOHOLD NO
KEEP
00: RDR FILE 0133 SENT FROM 10.222.111.24 PUN WAS 0133 RECS 334K CPY 001 A NOHOLD NO
KEEP
00: 0000003 FILES CHANGED
00: 0000003 FILES CHANGED
01: HCPGSP2627I The virtual machine is placed in CP mode due to a SIGP initial CPU reset from CPU 00.
02: HCPGSP2627I The virtual machine is placed in CP mode due to a SIGP initial CPU reset from CPU 00.
03: HCPGSP2627I The virtual machine is placed in CP mode due to a SIGP initial CPU reset from CPU 00.
~ 0.390935] Initsramfs unpacking failed: Decoding failed
Unable to find a medium container a live file system
```

- In the usual case that no parmfile was configured, the installation system now offers to interactively configure the basic network:

```
Attempt interactive netboot from a URL?
yes no (default yes): yes
```

```

Available qeth devices:
0.0.0600 0.0.0603
zdev to activate (comma separated, optional): 0600
QETH device 0.0.0600:0.0.0601:0.0.0602 configured
Two methods available for IP configuration:
 * static: for static IP configuration
 * dhcp: for automatic IP configuration
static dhcp (default 'dhcp'): static
ip: 10.222.111.24
gateway (default 10.222.111.1): .
dns (default .):
vlan id (optional):
 http://cdimage.ubuntu.com/ubuntu/releases/20.04.5/release/ubuntu-20.04.5-live-server-s390x.iso (default)
url: ftp://10.11.12.2:21/ubuntu-live-server-20.04.5/ubuntu-20.04.5-live-server-s390x.iso
http_proxy (optional):

```

- Make sure that the same version of the ISO image that was used to extract the installer files – kernel and initrd – is referenced at the ‘url:’ setting. It can be at a different location, for example directly referencing the public cdimage.ubuntu.com server: <http://cdimage.ubuntu.com/ubuntu/releases/20.04.5/release/ubuntu-20.04.5-live-server-s390x.iso>
- The boot-up of the live-server installation now completes:

```

Configuring networking...
QETH device 0.0.0600:0.0.0601:0.0.0602 already configured
IP-Config: enc600 hardware address 02:28:0a:00:00:39 mtu 1500
IP-Config: enc600 guessed broadcast address 10.222.111255
IP-Config: enc600 complete:
 address: 10.222.111.24    broadcast: 10.222.111255    netmask: 255.255.255.0

gateway: 10.222.111.1    dns0      : 10.222.111.1    dns1     : 0.0.0.0

rootserver: 0.0.0.0 rootpath:
filename :
Connecting to 10.11.12.2:21 (10.11.12.2:21)
focal-live-server-s  5% !*                ! 35.9M  0:00:17 ETA
focal-live-server-s 19% !*****          ! 129M  0:00:08 ETA
focal-live-server-s 33% !*****          ! 225M  0:00:05 ETA
focal-live-server-s 49% !*****          ! 330M  0:00:04 ETA
focal-live-server-s 60% !*****          ! 403M  0:00:03 ETA
focal-live-server-s 76% !*****          ! 506M  0:00:01 ETA
focal-live-server-s 89% !*****          ! 594M  0:00:00 ETA
focal-live-server-s 100% !*****          ! 663M  0:00:00 ETA
passwd: password expiry information changed.
QETH device 0.0.0600:0.0.0601:0.0.0602 already configured
no search or nameservers found in /run/net-enc600.conf /run/net-*.conf /run/net6
-*.conf
- 594.766372| /dev/loop3: Can't open blockdev
- 595.610434| systemd-1|: multi-user.target: Job getty.target/start deleted to
break ordering cycle starting with multi-user.target/start
- -0;1;31m SKIP -0m| Ordering cycle found, skipping -0;1;39mLogin Prompts -0m
- 595.623027| systemd-1|: Failed unmounting /cdrom.
- -0;1;31mFAILED -0m| Failed unmounting -0;1;39m/cdrom -0m.

- 598.973538| cloud-init-1256|: Cloud-init v. 20.2-45-g5f7825e2-0ubuntu1 runnin
g 'init-local' at Thu, 04 Jun 2020 12:06:46 +0000. Up 598.72 seconds.
- 599.829069| cloud-init-1288|: Cloud-init v. 20.2-45-g5f7825e2-0ubuntu1 runnin
g 'init' at Thu, 04 Jun 2020 12:06:47 +0000. Up 599.64 seconds.
- 599.829182| cloud-init-1288|: ci-info: ++++++Net device info+++++
- 599.829218| cloud-init-1288|: ci-info: +-----+-----+-----+-----+
-----+-----+-----+-----+
- 599.829255| cloud-init-1288|: ci-info: ! Device ! Up !           Address
!      Mask      ! Scope !      Hw-Address      !

```

```

- 599.829292| cloud-init-1288|: ci-info: +-----+-----+-----+-----+
-----+-----+-----+-----+
- 599.829333| cloud-init-1288|: ci-info: ! enc600 ! True !      10.222.111.24
! 255.255.255.0 ! global ! 02:28:0a:00:00:39 !
- 599.829376| cloud-init-1288|: ci-info: ! enc600 ! True ! fe80::28:aff:fe00:3
/64 !      .      ! link ! 02:28:0a:00:00:39 !
- 599.829416| cloud-init-1288|: ci-info: ! lo ! True !      127.0.0.1
! 255.0.0.0 ! host !      .      !
- 599.829606| cloud-init-1288|: ci-info: ! lo ! True !      ::1/128
!      .      ! host !      .      !
- 599.829684| cloud-init-1288|: ci-info: +-----+-----+-----+-----+
-----+-----+-----+-----+
- 599.829721| cloud-init-1288|: ci-info: ++++++Route IP
v4 info+++++
- 599.829754| cloud-init-1288|: ci-info: +-----+-----+-----+-----+
+-----+-----+-----+-----+
- 599.829789| cloud-init-1288|: ci-info: ! Route ! Destination ! Gateway
! Genmask ! Interface ! Flags !
- 599.829822| cloud-init-1288|: ci-info: +-----+-----+-----+-----+
+-----+-----+-----+-----+
- 599.829858| cloud-init-1288|: ci-info: ! 0 ! 0.0.0.0 ! 10.222.111.1
! 0.0.0.0 ! enc600 ! UG !
- 599.829896| cloud-init-1288|: ci-info: ! 1 ! 10.222.1110 ! 0.0.0.0
! 255.255.255.0 ! enc600 ! U !
- 599.829930| cloud-init-1288|: ci-info: +-----+-----+-----+-----+
+-----+-----+-----+-----+
- 599.829962| cloud-init-1288|: ci-info: ++++++Route IPv6 info++++
+++++
- 599.829998| cloud-init-1288|: ci-info: +-----+-----+-----+-----+
-----+-----+-----+-----+
- 599.830031| cloud-init-1288|: ci-info: ! Route ! Destination ! Gateway ! Inte
rface ! Flags !
- 599.830064| cloud-init-1288|: ci-info: +-----+-----+-----+-----+
-----+-----+-----+-----+
- 599.830096| cloud-init-1288|: ci-info: ! 1 ! fe80::/64 ! :: ! en
c600 ! U !
- 599.830131| cloud-init-1288|: ci-info: ! 3 ! local ! :: ! en
c600 ! U !
- 599.830164| cloud-init-1288|: ci-info: ! 4 ! ff00::/8 ! :: ! en
c600 ! U !
- 599.830212| cloud-init-1288|: ci-info: +-----+-----+-----+-----+
-----+-----+-----+-----+
- 601.077953| cloud-init-1288|: Generating public/private rsa key pair.
- 601.078101| cloud-init-1288|: Your identification has been saved in /etc/ssh/
ssh_host_rsa_key
- 601.078136| cloud-init-1288|: Your public key has been saved in /etc/ssh/ssh
host_rsa_key.pub
- 601.078170| cloud-init-1288|: The key fingerprint is:
- 601.078203| cloud-init-1288|: SHA256:kHtkABZwk8AE80fy0KPzTRcYpht4iXdZmJ37Cgi3
fJ0 root@ubuntu-server
- 601.078236| cloud-init-1288|: The key's randomart image is:
- 601.078274| cloud-init-1288|: +---RSA 3072|----+
- 601.078307| cloud-init-1288|: !o+*+B++*.. !
- 601.078340| cloud-init-1288|: ! o.X+==+ !
- 601.078373| cloud-init-1288|: ! +.0.= oo !
- 601.078406| cloud-init-1288|: ! ++.+.=o !
- 601.078439| cloud-init-1288|: ! *.=.oSo !
- 601.078471| cloud-init-1288|: ! = +.E . !
- 601.078503| cloud-init-1288|: ! . . . !
- 601.078537| cloud-init-1288|: ! . !
- 601.078570| cloud-init-1288|: ! !
- 601.078602| cloud-init-1288|: +-----SHA256|-----+
- 601.078635| cloud-init-1288|: Generating public/private dsa key pair.

```

```

- 601.078671| cloud-init-1288|: Your identification has been saved in /etc/ssh/
ssh_host_dsa_key
- 601.078704| cloud-init-1288|: Your public key has been saved in /etc/ssh/ssh_
host_dsa_key.pub
- 601.078736| cloud-init-1288|: The key fingerprint is:
- 601.078767| cloud-init-1288|: SHA256:ZBNyksVYVZVhKJeL+PWKpsdUcn2lyiceX/DboXQd
Pq0 root@ubuntu-server
- 601.078800| cloud-init-1288|: The key's randomart image is:
- 601.078835| cloud-init-1288|: +----DSA 1024|----+
- 601.078867| cloud-init-1288|: !      o++...+=+o !
- 601.078899| cloud-init-1288|: !      .+....+.. !
- 601.078932| cloud-init-1288|: !      +. + o o!
- 601.078964| cloud-init-1288|: !      o..o = oo.!
- 601.078996| cloud-init-1288|: !      S. =..o++!
- 601.079029| cloud-init-1288|: !      o *,*=!
- 601.079061| cloud-init-1288|: !      o .o.B.*!
- 601.079094| cloud-init-1288|: !      = .oEo.!
- 601.079135| cloud-init-1288|: !      .+      !
- 601.079167| cloud-init-1288|: +-----SHA256|-----+
- 601.079199| cloud-init-1288|: Generating public/private ecdsa key pair.
- 601.079231| cloud-init-1288|: Your identification has been saved in /etc/ssh/
ssh_host_ecdsa_key
- 601.079263| cloud-init-1288|: Your public key has been saved in /etc/ssh/ssh_
host_ecdsa_key.pub
- 601.079295| cloud-init-1288|: The key fingerprint is:
- 601.079327| cloud-init-1288|: SHA256:Bitar9fVHUH2FnYVSJJnldprdAcM5Est0dmRWFTU
i8k root@ubuntu-server
- 601.079362| cloud-init-1288|: The key's randomart image is:
- 601.079394| cloud-init-1288|: +----ECDSA 256|---+
- 601.079426| cloud-init-1288|: !      o**0%&!
- 601.079458| cloud-init-1288|: !      o.OB+=!
- 601.079491| cloud-init-1288|: !      .      B *o+!
- 601.079525| cloud-init-1288|: !      o      . E.=o!
- 601.079557| cloud-init-1288|: !      o . S .....+!
- 601.079589| cloud-init-1288|: !      o o . . . .o !
- 601.079621| cloud-init-1288|: !      . . . . . !
- 601.079653| cloud-init-1288|: !      .. .      !
- 601.079685| cloud-init-1288|: !      ..      !
- 601.079717| cloud-init-1288|: +-----SHA256|-----+
- 601.079748| cloud-init-1288|: Generating public/private ed25519 key pair.
- 601.079782| cloud-init-1288|: Your identification has been saved in /etc/ssh/
ssh_host_ed25519_key
- 601.079814| cloud-init-1288|: Your public key has been saved in /etc/ssh/ssh_
host_ed25519_key.pub
- 601.079847| cloud-init-1288|: The key fingerprint is:
- 601.079879| cloud-init-1288|: SHA256:yWsZ/5+7u7D3SIcd7HYnyajXyewnt5nQ+ZI3So3b
eN8 root@ubuntu-server
- 601.079911| cloud-init-1288|: The key's randomart image is:
- 601.079942| cloud-init-1288|: +---ED25519 256|---+
- 601.079974| cloud-init-1288|: !      !
- 601.080010| cloud-init-1288|: !      !
- 601.080042| cloud-init-1288|: !      !
- 601.080076| cloud-init-1288|: !      . . .      !
- 601.080107| cloud-init-1288|: !      S      o !
- 601.080139| cloud-init-1288|: !      =      o+++!
- 601.080179| cloud-init-1288|: !      + . o**$=!
- 601.080210| cloud-init-1288|: !      . oo+&B%!
- 601.080244| cloud-init-1288|: !      ..o*/E!
- 601.080289| cloud-init-1288|: +-----SHA256|-----+
- 612.293731| cloud-init-2027|: Cloud-init v. 20.2-45-g5f7825e2-0ubuntu1 runnin
g 'modules:config' at Thu, 04 Jun 2020 12:06:59 +0000. Up 612.11 seconds.
- 612.293866| cloud-init-2027|: Set the following 'random' passwords
- 612.293940| cloud-init-2027|: installer:wgYsAPzYQbFYqu2X2hYm

```

```

ci-info: no authorized SSH keys fingerprints found for user installer.
<14>Jun  4 12:07:00 ec2:
<14>Jun  4 12:07:00 ec2: #####
#####
<14>Jun  4 12:07:00 ec2: -----BEGIN SSH HOST KEY FINGERPRINTS-----
<14>Jun  4 12:07:00 ec2: 1024 SHA256:ZBNyKsVVYzVhKJeL+PWKpsdUcn21yiceX/DboXQdPq0
root@ubuntu-server (DSA)
<14>Jun  4 12:07:00 ec2: 256 SHA256:Bitar9fVHUH2FnYVSJJnldprdAcM5Est0dmRWFTUi8k
root@ubuntu-server (ECDSA)
<14>Jun  4 12:07:00 ec2: 256 SHA256:yWsZ/5+7u7D3SIcd7HYnyajXyeWnt5nQ+ZI3So3beN8
root@ubuntu-server (ED25519)
<14>Jun  4 12:07:00 ec2: 3072 SHA256:kHtkABZwk8AE80fy0KPzTRcYpht4iXdZmJ37Cgi3fJ0
root@ubuntu-server (RSA)
<14>Jun  4 12:07:00 ec2: -----END SSH HOST KEY FINGERPRINTS-----
<14>Jun  4 12:07:00 ec2: #####
#####
-----BEGIN SSH HOST KEY KEYS-----
ecdsa-sha2-nistp256 AAAAE2VjZHNhLXNoYTItbmlzdHAyNTYAAAAIbmlzdHAyNTYAAABBBIXM6t1/
35ot/aPI59ThIJBzg+qGJJ17+1ZVHfzMEDbsTwpM7e9pstPZUM7W1IHwqDvLQDBm/hGg4u8ZGEqmIMI=
root@ubuntu-server
ssh-ed25519 AAAAC3NzaC1lZDI1NTE5AAAAIN7QtU+en+RGruj2zuxWgkMqLmh+35/GR/OE0D16k4nA
root@ubuntu-server
ssh-rsa AAAAB3NzaC1yc2EAAAADAQABAAQGDJdKT7iUAvSjkUqI1l3fHysE+Gj7ulwGgGjYh639px
kcHEbbS3V48eR0Y9BmDISEHfjYXGY2wEH0tGJJNRR0GJhZJVNR+qAqJBioj9d/TwXEgWLP8eAy9aVtJB
K1rIylnMQltx/SIHgiymjHLCtKlVoIS4l0frT9FiF54Qi/JeJlwGJIW3W2XgcY90DT0Q5g3PSmlZ8KTR
imTf9Fy7WJEPa08b3fimYwsz9enuS/gECEUGV3M1MvrzpaQju27NUE0pSMZHR62IMxGvIjYIu3dUKAzM
MBdwxHdLMQ8rI8PehyHdiFr6g2Ixfxoy5QLmb3hISKlq/R6pLLeXbb748gN2i8WcVk0AEGfa/kJDW3RNU
VYd+ACBBzyhVbiv7WlCQW/ohik3wyosUyi9nJq2Iq0A7kkGH+1XoYq/e4/MoqxhIK/oaiudYAKaCwmp1
r/fBa3hlf0f7mVHvxA3tWZc2wYUxFTmePvpydP2PSctHMHgboaHrGIY2CdSqq8SUDPKr0E= root@ub
untu-server
-----END SSH HOST KEY KEYS-----
- 612.877357| cloud-init-2045|: Cloud-init v. 20.2-45-g5f7825e2-0ubuntu1 runnin
g 'modules:final' at Thu, 04 Jun 2020 12:07:00 +0000. Up 612.79 seconds.
- 612.877426| cloud-init-2045|: ci-info: no authorized SSH keys fingerprints fo
und for user installer.
- 612.877468| cloud-init-2045|: Cloud-init v. 20.2-45-g5f7825e2-0ubuntu1 finish
ed at Thu, 04 Jun 2020 12:07:00 +0000. Datasource DataSourceNoCloud -seed=/var/l
ib/cloud/seed/nocloud|-dsmode=net|. Up 612.87 seconds
- 612.877509| cloud-init-2045|: Welcome to Ubuntu Server InstallerÜ
- 612.877551| cloud-init-2045|: Above you will find SSH host keys and a random
password set for the `installer` user. You can use these credentials to ssh-in a
nd complete the installation. If you provided SSH keys in the cloud-init datasou
rce, they were also provisioned to the installer user.
- 612.877634| cloud-init-2045|: If you have access to the graphical console, li
ke TTY1 or HMC ASCII terminal you can complete the installation there too.

```

It is possible to connect to the installer over the network, which might allow the use of a more capable terminal.

To connect, SSH to installer@10.222.111.24.

The password you should use is "KRuXtz5dURAYpkjcUvA".

The host key fingerprints are:

```

RSA      SHA256:3IvYmK0U5lQSKBx0VZUJMzdtXpz3RJl3dEQsg3UWc54
ECDSA    SHA256:xd1xnkBpn49DUbuP8uWro2mu1GM4MtnqR2WEWg1fS3o
ED25519  SHA256:Hk3+/4+X7NJBHL6/e/6xFhNXsbHBs0vt6i8YEFUepko

```

Ubuntu Focal Fossa (development branch) ubuntu-server ttyS0

- The next step is to remotely connect to the install system and to proceed with the Subiquity installer.
- Please notice that at the end of the installer boot-up process, all necessary data is provided to proceed with

running the installer in a remote SSH shell. The command to execute locally is:

```
user@workstation:~$ ssh installer@10.222.111.24
```

- A temporary random password for the installation was created and shared as well, which should be used without the leading and trailing double quotes:

```
"KRuXtz5dURAYPkcjcUvA"
```

```
user@workstation:~$ ssh installer@10.222.111.24
```

```
The authenticity of host '10.222.111.24 (10.222.111.24)' can't be established.
```

```
ECDSA key fingerprint is
```

```
SHA256:xd1xnkBpn49DUbuP8uWro2mu1GM4MtnqR2WEWg1fS3o.
```

```
Are you sure you want to continue connecting (yes/no/[fingerprint])? yes
```

```
Warning: Permanently added '10.222.111.24' (ECDSA) to the list of known hosts.
```

```
installer@10.222.111.24's password: KRuXtz5dURAYPkcjcUvA
```

- One may now temporarily see some login messages like these:

```
Welcome to Ubuntu Focal Fossa (development branch) (GNU/Linux 5.4.0-42-generic s390x)
```

```
* Documentation: https://help.ubuntu.com
* Management:   https://landscape.canonical.com
* Support:      https://ubuntu.com/pro
```

```
System information as of Wed Jun 3 17:32:10 UTC 2020
```

```
System load: 0.0      Memory usage: 2%   Processes:      146
Usage of /home: unknown  Swap usage: 0%   Users logged in: 0
```

```
0 updates can be installed immediately.
```

```
0 of these updates are security updates.
```

```
The programs included with the Ubuntu system are free software;
the exact distribution terms for each program are described in the
individual files in /usr/share/doc/*/copyright.
```

```
Ubuntu comes with ABSOLUTELY NO WARRANTY, to the extent permitted by applicable law.
```

- Eventually, the initial Subiquity installer screen appears:

```
=====
Willkommen! Bienvenue! Welcome! ????? ??????????! Welkom!
=====
```

```
Use UP, DOWN and ENTER keys to select your language.
```

```
[ English           > ]
[ Asturianu         > ]
[ Cataln            > ]
[ Hrvatski          > ]
[ Nederlands        > ]
[ Suomi             > ]
[ Francais          > ]
[ Deutsch           > ]
[ Magyar            > ]
[ Latvie?u          > ]
[ Norsk bokm?l      > ]
[ Polski            > ]
[ Espanol           > ]
```

- From here just proceed with the installation as usual ...
(I'm leaving some pretty standard screenshots here just to give an example for a basic installation ...)

```
=====
Keyboard configuration
```

```
Please select your keyboard layout below, or select "Identify keyboard" to
detect your layout automatically.
```

Layout: [English (US) v]

Variant: [English (US) v]

[Identify keyboard]

[Done]
[Back]

=====

Zdev setup

=====

ID	ONLINE	NAMES	
generic-ccw			^
0.0.0009		>	
0.0.000c		>	
0.0.000d		>	
0.0.000e		>	
dasd-eckd			
0.0.0190		>	
0.0.0191		>	
0.0.019d		>	
0.0.019e		>	
0.0.0200		>	
0.0.0300		>	
0.0.0400		>	
0.0.0592		>	v

[Continue]
[Back]

- If the list is long, hit the End key that will automatically scroll you down to the bottom of the Z devices list and screen.

=====

Zdev setup

=====

ID	ONLINE	NAMES	
generic-ccw			^
0.0.0009		>	
0.0.000c		>	
0.0.000d		>	
0.0.000e		>	
dasd-eckd			
0.0.0190		>	
0.0.0191		>	
0.0.019d		>	
0.0.019e		>	
0.0.0200		>	
0.0.0300		>	
0.0.0400		>	

>|< (close) |

>| Enable |

>| Disable |

0.0.0592 > _____ v

[Continue]
[Back]

=====
Zdev setup
=====

ID	ONLINE	NAMES	
generic-ccw			
0.0.0009			>
0.0.000c			>
0.0.000d			>
0.0.000e			>
dasd-eckd			
0.0.0190			>
0.0.0191			>
0.0.019d			>
0.0.019e			>
0.0.0200	online	dasda	>
0.0.0300			>
0.0.0400			>
0.0.0592			>

[Continue]
[Back]

=====
Zdev setup
=====

dasd-eckd			
0.0.0190			>
0.0.0191			>
0.0.019d			>
0.0.019e			>
0.0.0200	online	dasda	>
0.0.0300			>
0.0.0400			>
0.0.0592			>
qeth			
0.0.0600:0.0.0601:0.0.0602		enc600	>
0.0.0603:0.0.0604:0.0.0605			>
dasd-eckd			
0.0.1607			>

[Continue]
[Back]

=====
Network connections
=====

Configure at least one interface this server can use to talk to other machines, and which preferably provides sufficient access for updates.

NAME	TYPE	NOTES	
[enc600	eth	-	>]
static	10.222.111.24/24		
02:28:0a:00:00:39 / Unknown Vendor / Unknown Model			

[Create bond >]

[Done]
[Back]

=====
Configure proxy
=====

If this system requires a proxy to connect to the internet, enter its details here.

Proxy address:

If you need to use a HTTP proxy to access the outside world, enter the proxy information here. Otherwise, leave this blank.

The proxy information should be given in the standard form of "http://[[user][:pass]@]host[:port]/".

[Done]
[Back]

=====
Configure Ubuntu archive mirror
=====

If you use an alternative mirror for Ubuntu, enter its details here.

Mirror address: <http://ports.ubuntu.com/ubuntu-ports>

You may provide an archive mirror that will be used instead of the default.

[Done]
[Back]

=====
Guided storage configuration
=====

Configure a guided storage layout, or create a custom one:

Use an entire disk

[0X0200 local disk 6.876G v]

[] Set up this disk as an LVM group

[] Encrypt the LVM group with LUKS

Passphrase:

Confirm passphrase:

Custom storage layout

[Done]

[Back]

=====

Storage configuration

=====

FILE SYSTEM SUMMARY

MOUNT POINT	SIZE	TYPE	DEVICE TYPE
[/	6.875G	new ext4	new partition of local disk >]

AVAILABLE DEVICES

No available devices

[Create software RAID (md) >]

[Create volume group (LVM) >]

USED DEVICES

[Done]

[Reset]

[Back]

=====

Storage configuration

=====

FILE SYSTEM SUMMARY

Confirm destructive action

Selecting Continue below will begin the installation process and result in the loss of data on the disks selected to be formatted.

You will not be able to return to this or a previous screen once the installation has started.

Are you sure you want to continue?

[No]

[Continue]

```
[ Reset      ]
[ Back      ]
```

```
=====
Profile setup
=====
```

```
Enter the username and password you will use to log in to the system. You
can configure SSH access on the next screen but a password is still needed
for sudo.
```

```
Your name: Ed Example
```

```
Your server's name: 10.222.111.24
                    The name it uses when it talks to other computers.
```

```
Pick a username: ubuntu
```

```
Choose a password: *****
```

```
Confirm your password: *****
```

```
[ Done      ]
```

```
=====
SSH Setup
=====
```

```
You can choose to install the OpenSSH server package to enable secure remote
access to your server.
```

```
[ ] Install OpenSSH server
```

```
Import SSH identity: [ No          v ]
                    You can import your SSH keys from Github or Launchpad.
```

```
Import Username:
```

```
[X] Allow password authentication over SSH
```

```
[ Done      ]
[ Back      ]
```

- It's a nice and convenient new feature to add the user's SSH keys during the installation to the system, since that makes the system login password-less on the initial login!

```
=====
SSH Setup
=====
```

```
You can choose to install the OpenSSH server package to enable secure remote
access to your server.
```

```
[X] Install OpenSSH server
```

Import SSH identity: [from Launchpad v]
You can import your SSH keys from Github or Launchpad.

Launchpad Username: user
Enter your Launchpad username.

[X] Allow password authentication over SSH

[Done]
[Back]

SSH Setup

You can choose to install the OpenSSH server package to enable secure remote access to your server.

Confirm SSH keys

Keys with the following fingerprints were fetched. Do you want to use them?

2048 SHA256:joGsdFw7NbJRkg17sRyXaegoR0iZEdDwDR9Hpbc2KIw user@W520 |
(RSA)
521 SHA256:T3JzxvB6K1GzXJpP5NFgX4yXvk0jhhgvbw01F7/fZ2c
frank.heimes@canonical.com (ECDSA)

[Yes]
[No]

[Done]
[Back]

Featured Server Snaps

These are popular snaps in server environments. Select or deselect with SPACE, press ENTER to see more details of the package, publisher and versions available.

[] kata-containers Lightweight virtual machines that seamlessly plug into >
[] docker Docker container runtime >
[] mosquito Eclipse Mosquitto MQTT broker >
[] etcd Resilient key-value store by CoreOS >
[] stress-ng A tool to load, stress test and benchmark a computer s >
[] sabnzbd SABnzbd >
[] wormhole get things from one computer to another, safely >
[] slcli Python based SoftLayer API Tool. >
[] doctl DigitalOcean command line tool >
[] keepalived High availability VRRP/BFD and load-balancing for Linu >
[] juju Simple, secure and stable devops. Juju keeps complexit >

[Done]
[Back]

Install complete!

```
=====
configuring raid (mdadm) service ^
installing kernel
setting up swap
apply networking config
writing etc/fstab
configuring multipath
updating packages on target system
configuring pollinate user-agent on target
updating initramfs configuration
finalizing installation
  running 'curtin hook'
  curtin command hook
executing late commands
final system configuration
configuring cloud-init |
installing openssh-server | v
```

[View full log]

Installation complete!

```
=====
----- Finished install! -----
apply networking config ^
writing etc/fstab
configuring multipath
updating packages on target system
configuring pollinate user-agent on target
updating initramfs configuration
finalizing installation
  running 'curtin hook'
  curtin command hook
executing late commands
final system configuration
configuring cloud-init |
installing openssh-server |
restoring apt configuration |
downloading and installing security updates v
```

[View full log]

[Reboot]

Installation complete!

```
=====
----- Finished install! -----
apply networking config ^
writing etc/fstab
configuring multipath
updating packages on target system
configuring pollinate user-agent on target
updating initramfs configuration
finalizing installation
  running 'curtin hook'
  curtin command hook
executing late commands
final system configuration
configuring cloud-init |
installing openssh-server |
restoring apt configuration |
```

```

[ Connection to 10.222.111.24 closed by remote host.
Connection to 10.222.111.24 closed.
user@workstation:~$
    • Type reset to clear the screen and to revert it back to the defaults.
    • Now remove the old host key, since the system got a new one during the installation:
user@workstation:~$ ssh-keygen -f "/home/user/.ssh/known_hosts" -R "10.222.111.24"
# Host 10.222.111.24 found: line 159
/home/user/.ssh/known_hosts updated.
Original contents retained as /home/user/.ssh/known_hosts.old
user@workstation:~$
    • And finally login to the newly installed z/VM guest:
user@workstation:~$ ssh ubuntu@10.222.111.24
Warning: Permanently added the ECDSA host key for IP address
'10.222.111.24' to the list of known hosts.
Welcome to Ubuntu 20.04.5 LTS (GNU/Linux 5.4.0-42-generic s390x)

 * Documentation:  https://help.ubuntu.com
 * Management:    https://landscape.canonical.com
 * Support:       https://ubuntu.com/pro

System information as of Wed 03 Jun 2020 05:50:05 PM UTC

System load: 0.08          Memory usage: 2%   Processes:      157
Usage of /:  18.7% of 6.70GB  Swap usage:  0%   Users logged in: 0

0 updates can be installed immediately.
0 of these updates are security updates.

The programs included with the Ubuntu system are free software;
the exact distribution terms for each program are described in the individual files in /usr/share/doc/*/copyright.

Ubuntu comes with ABSOLUTELY NO WARRANTY, to the extent permitted by applicable law.

To run a command as administrator (user "root"), use "sudo <command>".
See "man sudo_root" for details.

ubuntu@10.222.111.24:~$ uptime
 17:50:09 up 1 min,  1 user,  load average: 0.08, 0.11, 0.05
ubuntu@10.222.111.24:~$ lsb_release -a
No LSB modules are available.
Distributor ID: Ubuntu
Description:  Ubuntu 20.04.5 LTS
Release:     20.04
Codename:    focal
ubuntu@10.222.111.24:~$ uname -a
Linux 10.222.111.24 5.4.0-42-generic #30-Ubuntu SMP Wed Aug 05 16:57:22 UTC 2020 s390x s390x s390x GNU/Linux
ubuntu@10.222.111.24:~$ exit
logout
Connection to 10.222.111.24 closed.
user@workstation:~$

```

Done !

Doing a manual live installation like described here - meaning without specifying a `parmfile` - is supported since Ubuntu Server LTS 20.04.5 ('Focal') and any newer release, like 22.04 ('Jammy').

The following guide assumes that an FTP server to host the installation files is in place, which can be used by the 'Load from Removable Media and Server' task of the Hardware Management Console (HMC).

- Download the ‘focal daily live image’ from here (later 20.04.5 image):
<http://cdimage.ubuntu.com/ubuntu/releases/20.04.5/release/ubuntu-20.04.5-live-server-s390x.iso>

- Now loop-back mount the ISO to extract four files that are needed for the installation:

```
user@workstation:~$ mkdir iso
user@workstation:~$ sudo mount -o loop ubuntu-20.04.5-live-server-s390x.iso iso
user@workstation:~$
```

```
user@workstation:~$ ls -l ./iso/boot/{ubuntu.exec,parmfile.*,kernel.u*,initrd.u*}
./iso/boot/initrd.ubuntu
./iso/boot/kernel.ubuntu
./iso/boot/parmfile.ubuntu
./iso/boot/ubuntu.exec
```

- Now make the files available via your FTP server.
- Open the IBM Z HMC and navigate to ‘Systems Management’ on your machine.
- Select the LPAR that you are going to install Ubuntu Server on. In this example we use LPAR s1lp11.
- Now select menu: ‘Recovery’ --> ‘Load from Removable Media or Server’ task.
- Fill out the ‘Load from Removable Media or Server’ form as follows (adapt the settings to your particular installation environment):

```
Load from Removable Media, or Server - <machine>:s1lp11
Use this task to load operating system software or utility programs
from a CD / DVD-ROM or a server that can be accessed using FTP.
Select the source of the software:
o Hardware Management Console CD / DVD-ROM
o Hardware Management Console CD / DVD-ROM and assign for operating system use
o Hardware Management Console USB flash memory drive
o Hardware Management Console USB flash memory drive and assign for operating system use
* FTP Source
  Host computer:  install-server
  User ID: ftpuser
  Password: *****
  Account (optional):
  File location (optional): ubuntu-live-server-20.04.5/boot
```

You may need to adjust the file’s location according to your install server environment.

- Confirm the entered data:

```
Load from Removable Media or Server - Select Software to Install -
<machine>:s1lp11
Select the software to install.
Select  Name                                     Description
*  ubuntu-live-server-20.04.5/boot/ubuntu.ins    Ubuntu for IBM Z (default kernel)
```

- Confirm again that jobs might be cancelled if proceeding:

```
Load from Removable Media or Server Task Confirmation -
<machine>:s1lp11
Load will cause jobs to be cancelled.
Do you want to continue with this task?
ACT33501
```

- And confirm a last time that it’s understood that the task is disruptive:

```
Disruptive Task Confirmation : Load from Removable Media or Server -
<machine>:s1lp11
```

Attention: The Load from Removable Media or Server task is disruptive.

Executing the Load from Removable Media or Server task may adversely affect the objects listed below. Review the confirmation text for each object before continuing with the Load from Removable Media or Server task.

Objects that will be affected by the Load from Removable Media or Server task

```
System Name      Type      OS Name      Status      Confirmation Text
<machine>:s1lp11 Image              Operating Load from Removable Media
or Server causes operations to be disrupted, since the target is
currently in use and operating normally.
```

Do you want to execute the Load from Removable Media or Server task?

- The 'Load from Removable media or Server' task is now executed:

```
Load from Removable media or Server Progress - P00B8F67:S1LPB
Turn on context sensitive help.
Function duration time: 00:55:00
Elapsed time: 00:00:04
Select      Object Name      Status
*           <machine> s1lp11 Please wait while the image is being loaded.
```

- This may take a moment, but you will soon see:

```
Load from Removable media or Server Progress - <machine>:s1lp11
Function duration time: 00:55:00
Elapsed time: 00:00:21
Select      Object Name      Status
*           <machine> s1lp11 Success
```

- Close the 'Load from Removable media or Server' task and open the console a.k.a. 'Operating System Messages' instead.

If no parmfile was configured or provided, one will find the following lines in the 'Operating System Messages' task:

```
Operating System Messages - <machine>:s1lp11
```

Message

```
Unable to find a medium container a live file system
Attempt interactive netboot from a URL?
yes no (default yes):
```

- By default, one will now see the interactive network configuration menu (again, only if no parmfile was prepared with sufficient network configuration information).
- Proceed with the interactive network configuration – in this case in a VLAN environment:

```
Unable to find a medium container a live file system
Attempt interactive netboot from a URL?
yes no (default yes):
yes
Available qeth devices:
0.0.c000 0.0.c003 0.0.c006 0.0.c009 0.0.c00c 0.0.c00f
zdev to activate (comma separated, optional):
0.0.c000
QETH device 0.0.c000:0.0.c001:0.0.c002 configured
Two methods available for IP configuration:
* static: for static IP configuration
* dhcp: for automatic IP configuration
static dhcp (default 'dhcp'):
static
ip:
10.222.111.11
gateway (default 10.222.111.1):
10.222.111.1
dns (default 10.222.111.1):
10.222.111.1
vlan id (optional):
```



```

+-----+-----+-----+
[ 407.026141] cloud-init[1348]: ci-info: | 0 | 0.0.0.0 | 10.222.111.1
| 0.0.0.0 | encc000.1234 | UG |
[ 407.026176] cloud-init[1348]: ci-info: | 1 | 10.222.111.0 | 0.0.0.0
| 255.255.255.0 | encc000.1234 | U |
[ 407.026212] cloud-init[1348]: ci-info: +-----+-----+-----+
+-----+-----+-----+
[ 407.026246] cloud-init[1348]: ci-info: ++++++Route IPv6 info+++
+++++
[ 407.026280] cloud-init[1348]: ci-info: +-----+-----+-----+
-----+-----+
[ 407.026315] cloud-init[1348]: ci-info: | Route | Destination | Gateway | Int
erface | Flags |
[ 407.026355] cloud-init[1348]: ci-info: +-----+-----+-----+
-----+-----+
[ 407.026390] cloud-init[1348]: ci-info: | 1 | fe80::/64 | :: | en
cc000 | U |
[ 407.026424] cloud-init[1348]: ci-info: | 2 | fe80::/64 | :: | encc
000.1234 | U |
[ 407.026458] cloud-init[1348]: ci-info: | 4 | local | :: | en
cc000 | U |
[ 407.026495] cloud-init[1348]: ci-info: | 5 | local | :: | encc
000.1234 | U |
[ 407.026531] cloud-init[1348]: ci-info: | 6 | ff00::/8 | :: | en
cc000 | U |
[ 407.026566] cloud-init[1348]: ci-info: | 7 | ff00::/8 | :: | encc
000.1234 | U |
[ 407.026600] cloud-init[1348]: ci-info: +-----+-----+-----+
-----+-----+
[ 407.883058] cloud-init[1348]: Generating public/private rsa key pair.
[ 407.883117] cloud-init[1348]: Your identification has been saved in /etc/ssh/
ssh_host_rsa_key
[ 407.883154] cloud-init[1348]: Your public key has been saved in /etc/ssh/ssh_
host_rsa_key.pub
[ 407.883190] cloud-init[1348]: The key fingerprint is:
[ 407.883232] cloud-init[1348]: SHA256:KX5cHC4YL9dXpvhnP6eSfS+J/zmKgg9zdlEzaEb+
RTA root@ubuntu-server
[ 407.883267] cloud-init[1348]: The key's randomart image is:
[ 407.883302] cloud-init[1348]: +---[RSA 3072]----+
[ 407.883338] cloud-init[1348]: | . E.. |
[ 407.883374] cloud-init[1348]: | o . o |
[ 407.883408] cloud-init[1348]: | . . = +o. |
[ 407.883443] cloud-init[1348]: | + =ooo++ |
[ 407.883478] cloud-init[1348]: | + S *.o. |
[ 407.883512] cloud-init[1348]: | . = o o. |
[ 407.883546] cloud-init[1348]: | .o+o ..+o. |
[ 407.883579] cloud-init[1348]: | o=.. =o+++|
[ 407.883613] cloud-init[1348]: | .... ++*0|
[ 407.883648] cloud-init[1348]: +----[SHA256]-----+
[ 407.883682] cloud-init[1348]: Generating public/private dsa key pair.
[ 407.883716] cloud-init[1348]: Your identification has been saved in /etc/ssh/
ssh_host_dsa_key
[ 407.883750] cloud-init[1348]: Your public key has been saved in /etc/ssh/ssh_
host_dsa_key.pub
[ 407.883784] cloud-init[1348]: The key fingerprint is:
[ 407.883817] cloud-init[1348]: SHA256:xu3vlG1BReKdy3DsuMZc/lg5y/+nhzlEmLDk/qFZ
Am0 root@ubuntu-server
[ 407.883851] cloud-init[1348]: The key's randomart image is:
[ 407.883905] cloud-init[1348]: +---[DSA 1024]----+
[ 407.883941] cloud-init[1348]: | ..o|
[ 407.883975] cloud-init[1348]: | o. o o |
[ 407.884008] cloud-init[1348]: | +.o+o+ |
[ 407.884042] cloud-init[1348]: | ...E*oo.. |

```

```

[ 407.884076] cloud-init[1348]: |          S+o =.. |
[ 407.884112] cloud-init[1348]: |          . +o+oo.o |
[ 407.884145] cloud-init[1348]: |          **+o*o |
[ 407.884179] cloud-init[1348]: |          .oo.*+oo|
[ 407.884212] cloud-init[1348]: |          .+ ===|
[ 407.884246] cloud-init[1348]: +----[SHA256]-----+
[ 407.884280] cloud-init[1348]: Generating public/private ecdsa key pair.
[ 407.884315] cloud-init[1348]: Your identification has been saved in /etc/ssh/
ssh_host_ecdsa_key
[ 407.884352] cloud-init[1348]: Your public key has been saved in /etc/ssh/ssh_
host_ecdsa_key.pub
[ 407.884388] cloud-init[1348]: The key fingerprint is:
[ 407.884422] cloud-init[1348]: SHA256:P+hBF3fj/pu6+0KaywUYii3Lyuc09Za9/a2eLCD0
gdE root@ubuntu-server
[ 407.884456] cloud-init[1348]: The key's randomart image is:
[ 407.884490] cloud-init[1348]: +---[ECDSA 256]---+
[ 407.884524] cloud-init[1348]: |          |
[ 407.884558] cloud-init[1348]: |          . |
[ 407.884591] cloud-init[1348]: |          ..E . o |
[ 407.884625] cloud-init[1348]: |          o .ooo o . |
[ 407.884660] cloud-init[1348]: |          o +S.+.. . |
[ 407.884694] cloud-init[1348]: |          . +..*oo.+ . |
[ 407.884728] cloud-init[1348]: |          = o+=.+.+ |
[ 407.884762] cloud-init[1348]: |          . o.....++o oo|
[ 407.884795] cloud-init[1348]: |          oo. . +.*@*+|
[ 407.884829] cloud-init[1348]: +----[SHA256]-----+
[ 407.884862] cloud-init[1348]: Generating public/private ed25519 key pair.
[ 407.884896] cloud-init[1348]: Your identification has been saved in /etc/ssh/
ssh_host_ed25519_key
[ 407.884930] cloud-init[1348]: Your public key has been saved in /etc/ssh/ssh_
host_ed25519_key.pub
[ 407.884966] cloud-init[1348]: The key fingerprint is:
[ 407.884999] cloud-init[1348]: SHA256:CbZpKR9eFHuB1sCDZwSdSdwJzy9FpsIWRIyc9ers
hZ0 root@ubuntu-server
[ 407.885033] cloud-init[1348]: The key's randomart image is:
[ 407.885066] cloud-init[1348]: +---[ED25519 256]--+
[ 407.885100] cloud-init[1348]: |          ../%X..o |
[ 407.885133] cloud-init[1348]: |          .o&*+= |
[ 407.885167] cloud-init[1348]: |          = .+*. * . |
[ 407.885200] cloud-init[1348]: |          . B = + o |
[ 407.885238] cloud-init[1348]: |          + S . . . |
[ 407.885274] cloud-init[1348]: |          . o o o |
[ 407.885308] cloud-init[1348]: |          + E |
[ 407.885345] cloud-init[1348]: |          . . |
[ 407.885378] cloud-init[1348]: |          . |
[ 407.885420] cloud-init[1348]: +----[SHA256]-----+
[ 418.521933] cloud-init[2185]: Cloud-init v. 20.2-45-g5f7825e2-0ubuntu1 runnin
g 'modules:config' at Wed, 03 Jun 2020 17:07:52 +0000. Up 418.40 seconds.
[ 418.522012] cloud-init[2185]: Set the following 'random' passwords
[ 418.522053] cloud-init[2185]: installer:C7BZrW76s4mJzmpf4eUy
ci-info: no authorized SSH keys fingerprints found for user installer.
<14>Jun  3 17:07:52 ec2:
<14>Jun  3 17:07:52 ec2: #####
#####
<14>Jun  3 17:07:52 ec2: -----BEGIN SSH HOST KEY FINGERPRINTS-----
<14>Jun  3 17:07:52 ec2: 1024 SHA256:xu3vLG1BRReKdy3DsuMZC/lG5y/+nhzLEmLDk/qFZAm0
root@ubuntu-server (DSA)
<14>Jun  3 17:07:52 ec2: 256 SHA256:P+hBF3fj/pu6+0KaywUYii3Lyuc09Za9/a2eLCD0gdE
root@ubuntu-server (ECDSA)
<14>Jun  3 17:07:52 ec2: 256 SHA256:CbZpKR9eFHuB1sCDZwSdSdwJzy9FpsIWRIyc9ershZ0
root@ubuntu-server (ED25519)
<14>Jun  3 17:07:52 ec2: 3072 SHA256:KX5cHC4YL9dXpvhnP6eSfS+J/zmKgg9zdLEzaEb+RTA
root@ubuntu-server (RSA)

```

```

<14>Jun  3 17:07:52 ec2: -----END SSH HOST KEY FINGERPRINTS-----
<14>Jun  3 17:07:52 ec2: #####
#####
-----BEGIN SSH HOST KEY KEYS-----
ecdsa-sha2-nistp256 AAAAE2VjZHNhLXNoYTItbmlzdHAyNTYAAAAIbmlzdHAyNTYAAABBC2zp4Fqr1+NJOIEQIISbX+EzeJ6ucXSLi2xEvurgwq8iMYT6yY0XB0Pc/XzeFa6vBCDZk3SSSW6Lq83y7VmdRQ=
root@ubuntu-server
ssh-ed25519 AAAAC3NzaC1lZDI1NTE5AAAAIJFzGips94nJNoR4QumiyqlJoSlZ48P+NVrd7zgD5k4T
root@ubuntu-server
ssh-rsa AAAAB3NzaC1yc2EAAAADAQABAAQChKo060715FAjd6ImK7qZbWnL/cpgQ2A2gQEeqFN0+1
joF/41ygxuw5aG0IQ0bWfPv9jDsMF5z4qHKzX8tFCpKC0s4uR8QBxh1dDm4wcwgcgTafVLqh7S4/R9Sqa
IFnkCzxThhNeMarcRrutY0mIzspmCg/QvfE1wrXJzL+Rt0J7GiuHHqpm76fX+6ZF1BYhkA87dXQiID2R
yUubSXKGg0NtzlgSzPqD3GB+HxRHHHLT5/Xq+njPq8jIUUpqSoHtkBupsyVmcD9gDbz6vng2PuBHwZP9X
17Qy0wxdxk4xIXaTup4g8bH1oF/czswqVxNdfB7XqzROFU0D9rMIB+DwBiHsmH1kRik4wwLi6IH4hu
xrykKvfb1xcZe65kR42oDI7JbBwvxGr0Kx8DrEXnBp0WozS0IDm2ZPh3ci/0uCJ4LTItByyCfAe/gyR
5si4SkmXrIXf5BnErZRgyJnfxKXmsFaSh7wf15w6GmsgzyD9sI2jES9+4By32ZzY0LDpi0s= root@ub
untu-server
-----END SSH HOST KEY KEYS-----
[ 418.872320] cloud-init[2203]: Cloud-init v. 20.2-45-g5f7825e2-0ubuntu1 runnin
g 'modules:final' at Wed, 03 Jun 2020 17:07:52 +0000. Up 418.79 seconds.
[ 418.872385] cloud-init[2203]: ci-info: no authorized SSH keys fingerprints fo
und for user installer.
[ 418.872433] cloud-init[2203]: Cloud-init v. 20.2-45-g5f7825e2-0ubuntu1 finish
ed at Wed, 03 Jun 2020 17:07:52 +0000. Datasource DataSourceNoCloud [seed=/var/l
ib/cloud/seed/nocloud][dsmode=net]. Up 418.86 seconds
[ 418.872484] cloud-init[2203]: Welcome to Ubuntu Server Installer!
[ 418.872529] cloud-init[2203]: Above you will find SSH host keys and a random
password set for the `installer` user. You can use these credentials to ssh-in a
nd complete the installation. If you provided SSH keys in the cloud-init datasou
rce, they were also provisioned to the installer user.
[ 418.872578] cloud-init[2203]: If you have access to the graphical console, li
ke TTY1 or HMC ASCII terminal you can complete the installation there too.

```

It is possible to connect to the installer over the network, which might allow the use of a more capable terminal.

To connect, SSH to installer@10.222.111.11.

The password you should use is "C7BZrW76s4mJzmpf4eUy".

The host key fingerprints are:

```

RSA      SHA256:KX5cHC4YL9dXpvhnP6eSfS+J/zmKgg9zdlEzaEb+RTA
ECDSA    SHA256:P+hBF3fj/pu6+0KaywUYii3Lyuc09Za9/a2eLCD0gdE
ED25519  SHA256:CbZpkR9eFHuB1sCDZwSdSdwJzy9FpsIWRiYc9ershZ0

```

Ubuntu Focal Fossa (development branch) ubuntu-server scli_line0
ubuntu-server login:

- At this point you can proceed with the regular installation either by using 'Recovery' --> 'Integrated ASCII Console' or with a remote SSH session.
- If the 'Integrated ASCII Console' was opened (you can hit F3 to refresh the task), the initial Subiquity installation screen is presented, which looks like this:

```

=====
Willkommen! Bienvenue! Welcome! ????? ?????????? Welkom!           [ Help ]
=====
Use UP, DOWN and ENTER keys to select your language.
[ English                > ]
[ Asturianu              > ]
[ Cataln                 > ]
[ Hrvatski               > ]
[ Nederlands             > ]

```

```

[ Suomi > ]
[ Francais > ]
[ Deutsch > ]
[ Magyar > ]
[ Latvie?u > ]
[ Norsk bokm?l > ]
[ Polski > ]
[ Espanol > ]

```

- Since the user experience is nicer in a remote SSH session, we recommend using that. However, with certain network environments it's just not possible to use a remote shell, and the 'Integrated ASCII Console' will be the only option.

Note:

At the end of the installer boot-up process, **all** necessary information is provided to proceed with a remote shell.

- The command to execute locally is:

```
user@workstation:~$ ssh installer@10.222.111.11
```

- A temporary random password for the installation was created and shared as well, which you should use without the leading and trailing double quotes:

```
"C7BZrW76s4mJzmpf4eUy"
```

- Hence the remote session for the installer can be opened by:

```
user@workstation:~$ ssh installer@10.222.111.11
The authenticity of host '10.222.111.11 (10.222.111.11)' can't be established.
ECDSA key fingerprint is SHA256:P+hBF3fj/pu6+0KaywUYii3Lyuc09Za9/a2elCD0gdE.
Are you sure you want to continue connecting (yes/no/[fingerprint])? yes
Warning: Permanently added '10.222.111.11' (ECDSA) to the list of known hosts.
installer@10.222.111.11's password: C7BZrW76s4mJzmpf4eUy
```

- One may swiftly see some login messages like the following ones:

```
Welcome to Ubuntu Focal Fossa (development branch) (GNU/Linux 5.4.0-42-generic s390x)

* Documentation:  https://help.ubuntu.com
* Management:    https://landscape.canonical.com
* Support:       https://ubuntu.com/pro
```

```
System information as of Wed Jun  3 17:32:10 UTC 2020
```

```
System load:   0.0      Memory usage: 2%   Processes:    146
Usage of /home: unknown  Swap usage:   0%   Users logged in: 0
```

```
0 updates can be installed immediately.
0 of these updates are security updates.
```

```
The programs included with the Ubuntu system are free software;
the exact distribution terms for each program are described in the
individual files in /usr/share/doc/*/copyright.
```

```
Ubuntu comes with ABSOLUTELY NO WARRANTY, to the extent permitted by
applicable law.
```

Eventually the initial Subiquity installer screen shows up:

```
=====
Willkommen! Bienvenue! Welcome! ????? ??????????!! Welkom!
=====
Use UP, DOWN and ENTER keys to select your language.

[ English > ]
[ Asturianu > ]
[ Cataln > ]
```

```

[ Hrvatski                > ]
[ Nederlands              > ]
[ Suomi                   > ]
[ Francais                > ]
[ Deutsch                 > ]
[ Magyar                  > ]
[ Latvie?u                > ]
[ Norsk bokm?l            > ]
[ Polski                  > ]
[ Espanol                 > ]

```

- From here just proceed with the installation as usual ...
(I'm leaving some pretty standard screenshots here just to give an example for a basic installation ...)

```

=====
Keyboard configuration
=====

```

Please select your keyboard layout below, or select "Identify keyboard" to detect your layout automatically.

```

Layout:  [ English (US)          v ]

```

```

Variant: [ English (US)          v ]

```

```

[ Identify keyboard ]

```

```

[ Done      ]
[ Back     ]

```

```

=====
Zdev setup
=====

```

```

ID                ONLINE  NAMES
-----
dasd-eckd
0.0.1600          >
0.0.1601          >
0.0.1602          >
0.0.1603          >
0.0.1604          >
0.0.1605          >
0.0.1606          >
0.0.1607          >
0.0.1608          >
0.0.1609          >
0.0.160a          >
0.0.160b          >
0.0.160c          >
0.0.160d          >

```

```

[ Continue ]
[ Back    ]

```

```

=====
Zdev setup
=====

```



```

ID                ONLINE NAMES                ^
|

dasd-eckd
0.0.1600          >
0.0.1601          > < (close)
0.0.1602          > Enable
0.0.1603          > Disable
0.0.1604          >
0.0.1605          >
0.0.1606          >
0.0.1607          >
0.0.1608          >
0.0.1609          >
0.0.160a         >
0.0.160b         >
0.0.160c         >
0.0.160d         >
|
v

[ Continue ]
[ Back    ]

```

```

=====
Zdev setup
=====

```

```

ID                ONLINE NAMES                ^
|

dasd-eckd
0.0.1600          >
0.0.1601          online dasda >
0.0.1602          >
0.0.1603          >
0.0.1604          >
0.0.1605          >
0.0.1606          >
0.0.1607          >
0.0.1608          >
0.0.1609          >
0.0.160a         >
0.0.160b         >
0.0.160c         >
0.0.160d         >
|
v

[ Continue ]
[ Back    ]

```

- One may hit the End key here – that will automatically scroll down to the bottom of the Z devices list and screen:

```

=====
Zdev setup
=====

```

```

0.0.f1de:0.0.f1df >
0.0.f1e0:0.0.f1e1 >
0.0.f1e2:0.0.f1e3 >
0.0.f1e4:0.0.f1e5 >
0.0.f1e6:0.0.f1e7 >
0.0.f1e8:0.0.f1e9 >
0.0.f1ea:0.0.f1eb >
0.0.f1ec:0.0.f1ed >
0.0.f1ee:0.0.f1ef >
0.0.f1f0:0.0.f1f1 >
0.0.f1f2:0.0.f1f3 >
0.0.f1f4:0.0.f1f5 >
0.0.f1f6:0.0.f1f7 >
|
^

```

```
0.0.f1f8:0.0.f1f9          >
0.0.f1fa:0.0.f1fb         >
0.0.f1fc:0.0.f1fd         > |
0.0.f1fe:0.0.f1ff         > v
```

```
[ Continue ]
[ Back     ]
```

=====
Network connections
=====

Configure at least one interface this server can use to talk to other machines, and which preferably provides sufficient access for updates.

```
NAME      TYPE  NOTES
[ encc000  eth  -          > ]
72:00:bb:00:aa:11 / Unknown Vendor / Unknown Model
```

```
[ encc000.1234  vlan  -          > ]
static      10.222.111.11/24
VLAN 1234 on interface encc000
```

```
[ Create bond > ]
```

```
[ Continue ]
[ Back     ]
```

- Depending on the installer version you are using you may face a little bug here. In that case the button will be named 'Continue without network', but the network is there. If you see that, just ignore it and continue ... (If you wait long enough the label will be refreshed and corrected.)

=====
Configure proxy
=====

If this system requires a proxy to connect to the internet, enter its details here.

Proxy address:

If you need to use a HTTP proxy to access the outside world, enter the proxy information here. Otherwise, leave this blank.

The proxy information should be given in the standard form of "http://[[user][:pass]@]host[:port]/".

```
[ Done     ]
[ Back     ]
```

=====
Configure Ubuntu archive mirror
=====

If you use an alternative mirror for Ubuntu, enter its details here.

[Done]
[Reset]
[Back]

=====

Storage configuration

=====

FILE SYSTEM SUMMARY

Confirm destructive action

Selecting Continue below will begin the installation process and result in the loss of data on the disks selected to be formatted.

You will not be able to return to this or a previous screen once the installation has started.

Are you sure you want to continue?

[No]
[Continue]

[Reset]
[Back]

=====

Profile setup

=====

Enter the username and password you will use to log in to the system. You can configure SSH access on the next screen but a password is still needed for sudo.

Your name: Ed Example

Your server's name: s1lp11
The name it uses when it talks to other computers.

Pick a username: ubuntu

Choose a password: *****

Confirm your password: *****

[Done]

=====

SSH Setup

=====

You can choose to install the OpenSSH server package to enable secure remote access to your server.

[] Install OpenSSH server

Import SSH identity: [No v]
You can import your SSH keys from Github or Launchpad.

Import Username:

Allow password authentication over SSH

[Done]
[Back]

- It's a nice and convenient new feature to add the user's SSH keys during the installation to the system, since that makes the system login password-less for the initial login!

SSH Setup

You can choose to install the OpenSSH server package to enable secure remote access to your server.

Install OpenSSH server

Import SSH identity: [from Launchpad v]
You can import your SSH keys from Github or Launchpad.

Launchpad Username: user
Enter your Launchpad username.

Allow password authentication over SSH

[Done]
[Back]

SSH Setup

You can choose to install the OpenSSH server package to enable secure remote access to your server.

Confirm SSH keys

Keys with the following fingerprints were fetched. Do you want to use them?

2048 SHA256:joGscmiamcaoincinaäonnväineorviZEdDwDR9HpbC2KIw user@w520
(RSA)

521 SHA256:T3JzxvB6K1Gzidvoidhoidsaoicak0jhhgVbw01F7/fZ2c
ed.example@acme.com (ECDSA)

[Yes]
[No]

[Done]
[Back]

Featured Server Snaps

```
| downloading and installing security updates | v |
```

```
[ View full log ]  
[ Reboot       ]
```

Installation complete!

```
=====
```

```
----- Finished install! -----
```

```
| apply networking config | ^ |  
| writing etc/fstab       | |  
| configuring multipath  | |  
| updating packages on  | |  
|   target system       | |  
| configuring pollinate  | |  
|   user-agent on target| |  
| updating initramfs    | |  
|   configuration       | |  
| finalizing installation| |  
|   running 'curtin hook'| |  
|   curtin command hook | |  
| executing late commands| |  
| final system configuration| |  
| configuring cloud-init | |  
| installing openssh-server| |  
| restoring apt configuration| |  
| downloading and installing security updates | v |
```

[Connection to 10.222.111.11 closed by remote host.

[Rebooting...]

Connection to 10.222.111.11 closed.

user@workstation:~\$

- Now type `reset` to clear the screen and reset it to its defaults.
- Before proceeding one needs to remove the old, temporary host key of the target system, since it was only for use during the installation:

```
user@workstation:~$ ssh-keygen -f "/home/user/.ssh/known_hosts" -R "s1lp11"  
# Host s1lp11 found: line 159  
/home/user/.ssh/known_hosts updated.  
Original contents retained as /home/user/.ssh/known_hosts.old  
user@workstation:~$
```

- And assuming the post-installation reboot is done, one can now login:

```
user@workstation:~$ ssh ubuntu@s1lp11  
Warning: Permanently added the ECDSA host key for IP address  
'10.222.111.11' to the list of known hosts.  
Welcome to Ubuntu 20.04.5 LTS (GNU/Linux 5.4.0-42-generic s390x)
```

```
* Documentation:  https://help.ubuntu.com  
* Management:    https://landscape.canonical.com  
* Support:       https://ubuntu.com/pro
```

System information as of Wed 03 Jun 2020 05:50:05 PM UTC

```
System load: 0.08          Memory usage: 2%   Processes:      157  
Usage of /:  18.7% of 6.70GB  Swap usage:  0%   Users logged in: 0
```

```
0 updates can be installed immediately.  
0 of these updates are security updates.
```

The programs included with the Ubuntu system are free software;
the exact distribution terms for each program are described in the
individual files in `/usr/share/doc/*/copyright`.

Ubuntu comes with ABSOLUTELY NO WARRANTY, to the extent permitted by applicable law.

To run a command as administrator (user "root"), use "sudo <command>".
See "man sudo_root" for details.

```
ubuntu@s1lp11:~$ uptime
 17:50:09 up 1 min,  1 user,  load average: 0.08, 0.11, 0.05
ubuntu@s1lp11:~$ lsb_release -a
No LSB modules are available.
Distributor ID: Ubuntu
Description:   Ubuntu 20.04.5 LTS
Release:      20.04
Codename:     focal
ubuntu@s1lp11:~$ uname -a
Linux s1lp11 5.4.0-42-generic #30-Ubuntu SMP Wed Aug 05 16:57:22 UTC 2020 s390x s390x s390x GNU/Linux
ubuntu@s1lp11:~$ exit
logout
Connection to s1lp11 closed.
user@workstation:~$
```

Done !

Introduction

Since version 20.04, the server installer supports automated installation mode (autoinstallation for short). You might also know this feature as *unattended*, *hands-off*, or *preseeded* installation.

Autoinstallation lets you answer all those configuration questions ahead of time with an *autoinstall config*, and lets the installation process run without any interaction.

Differences from debian-installer preseeding

Preseeds are the way to automate an installer based on debian-installer (a.k.a. *d-i*).

Autoinstalls for the new server installer differ from preseeds in the following main ways:

- The format is completely different (cloud-init config, usually YAML, vs. `debconf-set-selections` format).
- When the answer to a question is not present in a preseed, *d-i* stops and asks the user for input. Autoinstalls are not like this: by default, if there is any autoinstall config at all, the installer takes the default for any unanswered question (and fails if there is no default).
 - You can designate particular sections in the config as “interactive”, which means the installer will still stop and ask about those.

Provide the autoinstall config via cloud-init

The autoinstall config is provided via cloud-init configuration, which is almost endlessly flexible. In most scenarios, the easiest way will be to provide user data [via the NoCloud datasource](#).

The autoinstall config should be provided under the `autoinstall` key in the config. For example:

```
#cloud-config
autoinstall:
  version: 1
...
```

Run a truly automatic autoinstall

Even if a fully non-interactive autoinstall config is found, the server installer will ask for confirmation before writing to the disks unless `autoinstall` is present on the kernel command line. This is to make it harder to accidentally create a USB stick that will reformat the machine it is plugged into at boot. Many autoinstalls will be done via netboot, where the kernel command line is controlled by the netboot config – just remember to put `autoinstall` in there!

Quick start

So you just want to try it out? Well we have [the page for you](#).

Create an autoinstall config

When any system is installed using the server installer, an autoinstall file for repeating the install is created at `/var/log/installer/autoinstall-user-data`.

Translate a preseed file

If you have a preseed file already, the [autoinstall-generator snap](#) can help translate that preseed data to an autoinstall file. See this discussion on the [autoinstall generator tool](#) for more details on how to set this up.

The structure of an autoinstall config

The autoinstall config has [full documentation](#).

Technically speaking, the config is not defined as a textual format, but cloud-init config is usually provided as YAML so that is the syntax the documentation uses. A minimal config consists of:

```
version: 1
identity:
  hostname: hostname
  username: username
  password: $crypted_pass
```

However, here is a more complete example file that shows off most features:

```
version: 1
reporting:
  hook:
    type: webhook
    endpoint: http://example.com/endpoint/path
early-commands:
  - ping -c1 198.162.1.1
locale: en_US
keyboard:
  layout: gb
  variant: dvorak
network:
  network:
    version: 2
    ethernets:
      enp0s25:
        dhcp4: yes
      enp3s0: {}
      enp4s0: {}
    bonds:
      bond0:
        dhcp4: yes
        interfaces:
          - enp3s0
          - enp4s0
        parameters:
          mode: active-backup
          primary: enp3s0
proxy: http://squid.internal:3128/
apt:
  primary:
    - arches: [default]
    uri: http://repo.internal/
sources:
  my-ppa.list:
    source: "deb http://ppa.launchpad.net/curtin-dev/test-archive/ubuntu $RELEASE main"
    keyid: B59D 5F15 97A5 04B7 E230 6DCA 0620 BBCF 0368 3F77
storage:
  layout:
    name: lvm
identity:
  hostname: hostname
  username: username
  password: $crypted_pass
ssh:
  install-server: yes
```

```

authorized-keys:
  - $key
allow-pw: no
snaps:
  - name: go
    channel: 1.14/stable
    classic: true
debconf-selections: |
  bind9      bind9/run-resolvconf    boolean false
packages:
  - libreoffice
  - dns-server^
user-data:
  disable_root: false
late-commands:
  - sed -ie 's/GRUB_TIMEOUT=.*/GRUB_TIMEOUT=30/' /target/etc/default/grub
error-commands:
  - tar c /var/log/installer | nc 192.168.0.1 1000

```

Many keys and values correspond straightforwardly to questions the installer asks (e.g. keyboard selection). See the reference for details of those that do not.

Error handling

Progress through the installer is reported via `error-commands` are executed and the traceback printed to the console. The server then just waits.

Interactions between autoinstall and cloud-init

Delivery of autoinstall

Cloud-config can be used to deliver the autoinstall data to the installation environment. The [autoinstall quickstart](#) has an example of [writing the autoinstall config](#).

Note that autoinstall is processed by Subiquity (not cloud-init), so please direct defects in autoinstall behavior and [bug reports to Subiquity](#).

The installation environment

At install time, the live-server environment is just that: a live but ephemeral copy of Ubuntu Server. This means that cloud-init is present and running in that environment, and existing methods of interacting with cloud-init can be used to configure the live-server ephemeral environment. For example, any `#cloud-config` user data keys are presented to the live-server containing `ssh_import_id`, then SSH keys will be added to the `authorized_keys` list for the ephemeral environment.

First boot configuration of the target system

Autoinstall data may optionally contain a `user data sub-section`, which is cloud-config data that is used to configure the target system on first boot.

Subiquity itself delegates some configuration items to cloud-init, and these items are processed on first boot.

Starting with Ubuntu 22.10, once cloud-init has performed this first boot configuration, it will disable itself as cloud-init completes configuration in the target system on first boot.

Possible future directions

We might want to extend the ‘match specs’ for disks to cover other ways of selecting disks.

The intent of this page is to provide simple instructions to perform an autoinstall in a VM on your machine.

This page assumes that you are willing to install the latest Ubuntu release available (22.10 at the time of writing). For other releases, you would need to substitute the name of the ISO image but the instructions should otherwise remain the same.

This page also assumes you are on the amd64 architecture. There is a [version for s390x](#) too.

Providing the autoinstall data over the network

This method is the one that generalises most easily to doing an entirely network-based install, where a machine netboots and is then automatically installed.

Download the ISO

Go to the [22.10 ISO download page](#) and download the latest Ubuntu 22.10 live-server ISO.

Mount the ISO

```
sudo mount -r ~/Downloads/ubuntu-22.10-live-server-amd64.iso /mnt
```

Write your autoinstall config

This means creating cloud-init config as follows:

```
mkdir -p ~/www
cd ~/www
cat > user-data << 'EOF'
#cloud-config
autoinstall:
  version: 1
  identity:
    hostname: ubuntu-server
    password: "$6$exDY1mhS4KUYCE/2$zmn9ToZwTKLhCw.b4/b.ZRTIZM30JZ4Qr0Q2a0XJ8yk96xpcCof0kxKwuX1kqLG/ygbJ1f8wxED22bTL4F46
    username: ubuntu
EOF
touch meta-data
```

The crypted password is just “ubuntu”.

Serve the cloud-init config over HTTP

Leave this running in a new terminal window:

```
cd ~/www
python3 -m http.server 3003
```

Create a target disk

```
truncate -s 10G image.img
```

Run the install!

```
kvm -no-reboot -m 2048 \
  -drive file=image.img,format=raw,cache=none,if=virtio \
  -cdrom ~/Downloads/ubuntu-22.10-live-server-amd64.iso \
  -kernel /mnt/casper/vmlinuz \
  -initrd /mnt/casper/initrd \
  -append 'autoinstall ds=nocloud-net;s=http://_gateway:3003/'
```

This will boot, download the config from the server set up in the previous step, and run the install. The installer reboots at the end but the `-no-reboot` flag to `kvm` means that `kvm` will exit when this happens. It should take about 5 minutes.

Boot the installed system

```
kvm -no-reboot -m 2048 \
  -drive file=image.img,format=raw,cache=none,if=virtio
```

This will boot into the freshly installed system and you should be able to log in as `ubuntu/ubuntu`.

Using another volume to provide the autoinstall config

This is the method to use when you want to create media that you can just plug into a system to have it be installed.

Download the live-server ISO

Go to the [22.10 ISO download page](#) and download the latest Ubuntu 22.10 live-server ISO.

Create your user-data and meta-data files

```
mkdir -p ~/cidata
cd ~/cidata
cat > user-data << 'EOF'
#cloud-config
autoinstall:
  version: 1
  identity:
    hostname: ubuntu-server
    password: "$6$exDY1mhS4KUYCE/2$zmn9ToZwTKLhCw.b4/b.ZRTIZM30JZ4Qr0Q2a0XJ8yk96xpcCof0kxKwuX1kqLG/ygbJ1f8wxED22bTL4F4
    username: ubuntu
EOF
touch meta-data
```

The crypted password is just “ubuntu”.

Create an ISO to use as a cloud-init data source

```
sudo apt install cloud-image-utils
cloud-localds ~/seed.iso user-data meta-data
```

Create a target disk

```
truncate -s 10G image.img
```

Run the install!

```
kvm -no-reboot -m 2048 \
  -drive file=image.img,format=raw,cache=none,if=virtio \
  -drive file=~/seed.iso,format=raw,cache=none,if=virtio \
  -cdrom ~/Downloads/ubuntu-22.10-live-server-amd64.iso
```

This will boot and run the install. Unless you interrupt boot to add `autoinstall` to the kernel command line, the installer will prompt for confirmation before touching the disk.

The installer reboots at the end but the `-no-reboot` flag to `kvm` means that `kvm` will exit when this happens.

The whole process should take about 5 minutes.

Boot the installed system

```
kvm -no-reboot -m 2048 \
  -drive file=image.img,format=raw,cache=none,if=virtio
```

This will boot into the freshly installed system and you should be able to log in as `ubuntu/ubuntu`.

The intent of this page is to provide simple instructions to perform an autoinstall in a VM on your machine on s390x.

This page is just a slightly adapted page of [the autoinstall quickstart page](#) mapped to s390x.

Download an ISO

At the time of writing (just after the kinetic release), the best place to go is here:

<https://cdimage.ubuntu.com/ubuntu/releases/22.10/release/>

```
wget https://cdimage.ubuntu.com/ubuntu/releases/22.10/release/ubuntu-22.10-live-server-s390x.iso -P ~/Downloads
```

Mount the ISO

```
mkdir -p ~/iso
sudo mount -r ~/Downloads/ubuntu-22.10-live-server-s390x.iso ~/iso
```

Write your autoinstall config

This means creating a cloud-init `#cloud-config` file as follows:

```
mkdir -p ~/www
cd ~/www
cat > user-data << 'EOF'
#cloud-config
autoinstall:
  version: 1
  identity:
    hostname: ubuntu-server
    password: "$6$exDY1mhS4KUYCE/2$zmn9ToZwTKLhCw.b4/b.ZRTIZM30JZ4Qr0Q2a0XJ8yk96xpcCof0kxKwuX1kqLG/ygbJ1f8wxED22bTL4F46
    username: ubuntu
EOF
touch meta-data
```

The crypted password is just “ubuntu”.

Serve the cloud-init config over HTTP

Leave this running in a new terminal window:

```
cd ~/www
python3 -m http.server 3003
```

Create a target disk

Proceed with a second terminal window:

```
sudo apt install qemu-utils

qemu-img create -f qcow2 disk-image.qcow2 10G
Formatting 'disk-image.qcow2', fmt=qcow2 size=10737418240 cluster_size=65536 lazy_refcounts=off refcount_bits=16

qemu-img info disk-image.qcow2
image: disk-image.qcow2
file format: qcow2
virtual size: 10 GiB (10737418240 bytes)
disk size: 196 KiB
cluster_size: 65536
Format specific information:
  compat: 1.1
  lazy refcounts: false
  refcount bits: 16
  corrupt: false
```

Run the install!

```
sudo apt install qemu-kvm
```

You may need to add the default user to the kvm group:

```
sudo usermod -a -G kvm ubuntu
```

Note:

You will need to re-login to make the changes take effect.

```
kvm -no-reboot -name auto-inst-test -nographic -m 2048 \
-drive file=disk-image.qcow2,format=qcow2,cache=none,if=virtio \
-cdrom ~/Downloads/ubuntu-22.10-live-server-s390x.iso \
-kernel ~/iso/boot/kernel.ubuntu \
-initrd ~/iso/boot/initrd.ubuntu \
-append 'autoinstall ds=nocloud-net;s=http://_gateway:3003/ console=ttysclp0'
```

This will boot, download the config from the server set up in the previous step and run the install. The installer reboots at the end but the `-no-reboot` flag to `kvm` means that `kvm` will exit when this happens. It should take about 5 minutes.

Boot the installed system

```
kvm -no-reboot -name auto-inst-test -nographic -m 2048 \  
-drive file=disk-image.qcow2,format=qcow2,cache=none,if=virtio
```

This will boot into the freshly installed system and you should be able to log in as `ubuntu/ubuntu`.

Overall format

The autoinstall file is YAML. At top level it must be a mapping containing the keys described in this document. Unrecognized keys are ignored.

Schema

Autoinstall configs are validated against a JSON schema before they are used.

Command lists

Several config keys are lists of commands to be executed. Each command can be a string (in which case it is executed via “`sh -c`”) or a list, in which case it is executed directly. Any command exiting with a non-zero return code is considered an error and aborts the install (except for error-commands, where it is ignored).

Top-level keys

version

type: integer

default: no default

A future-proofing config file version field. Currently this must be “1”.

interactive-sections

type: list of strings

default: []

A list of config keys to still show in the UI. So for example:

```
version: 1  
interactive-sections:  
- network  
identity:  
  username: ubuntu  
  password: $crypted_pass
```

Would stop on the network screen and allow the user to change the defaults. If a value is provided for an interactive section it is used as the default.

You can use the special section name of “*” to indicate that the installer should ask all the usual questions – in this case, the `autoinstall.yaml` file is not really an “autoinstall” file at all, instead just a way to change the defaults in the UI.

Not all config keys correspond to screens in the UI. This documentation indicates if a given section can be interactive or not.

If there are any interactive sections at all, the `reporting` key is ignored.

early-commands

type: command list

default: no commands

can be interactive: no

A list of shell commands to invoke as soon as the installer starts, in particular before probing for block and network devices. The autoinstall config is available at `/autoinstall.yaml` (irrespective of how it was provided) and the file will be re-read after the `early-commands` have run to allow them to alter the config if necessary.

locale

type: string

default: en_US.UTF-8

can be interactive: yes, always interactive if any section is

The locale to configure for the installed system.

refresh-installer

type: mapping

default: see below

can be interactive: yes

Controls whether the installer updates to a new version available in the given channel before continuing.

The mapping contains keys:

update

type: boolean

default: no

Whether to update or not.

channel

type: string

default: "stable/ubuntu-\$REL"

The channel to check for updates.

keyboard

type: mapping, see below

default: US English keyboard

can be interactive: yes

The layout of any attached keyboard. Often systems being automatically installed will not have a keyboard at all in which case the value used here does not matter.

The mapping's keys correspond to settings in the `/etc/default/keyboard` configuration file. See [its manual page](#) for more details.

The mapping contains keys:

layout

type: string

default: "us"

Corresponds to the `XKBLAYOUT` setting.

variant

type: string

default: ""

Corresponds to the `XKBVARIANT` setting.

toggle

type: string or null

default: null

Corresponds to the value of `grp:` option from the `XKBOPTIONS` setting. Acceptable values are (but note that the installer does not validate these): `caps_toggle`, `toggle`, `rctrl_toggle`, `rshift_toggle`, `rwin_toggle`, `menu_toggle`, `alt_shift_toggle`, `ctrl_shift_toggle`, `ctrl_alt_toggle`, `alt_caps_toggle`, `lctrl_lshift_toggle`, `lalt_toggle`, `lctrl_toggle`, `lshift_toggle`, `lwin_toggle`, `sclk_toggle`

The version of Subiquity released with 20.04 GA does not accept null for this field due to a bug.

source

type: mapping, see below

default: see below

can be interactive: yes

search_drivers

type: boolean

default: true

Whether the installer should search for available third-party drivers. When set to `false`, it disables the drivers screen and [section](#).

id

type: string

default: identifier of the first available source.

Identifier of the source to install (e.g., "ubuntu-server-minimized").

network

type: netplan-format mapping, see below

default: DHCP on interfaces named `eth*` or `en*`

can be interactive: yes

[Netplan-formatted](#) network configuration. This will be applied during installation as well as in the installed system. The default is to interpret the config for the install media, which runs DHCPv4 on any interface with a name matching "eth*" or "en*" but then disables any interface that does not receive an address.

For example, to run DHCPv6 on a particular NIC:

```
network:
  version: 2
  ethernets:
    enp0s31f6:
      dhcp6: yes
```

Note that thanks to a bug, the version of Subiquity released with 20.04 GA forces you to write this with an extra `network:` key like so:

```
network:
  network:
    version: 2
    ethernets:
      enp0s31f6:
        dhcp6: yes
```

Later versions support this syntax too for compatibility but if you can assume a newer version you should use the former.

proxy

type: URL or null

default: no proxy

can be interactive: yes

The proxy to configure both during installation and for `apt` and for `snapt` in the target system.

apt

type: mapping

default: see below

can be interactive: yes

Apt configuration, used both during the install and once booted into the target system.

This section historically used the same format as `curtin`, [which is documented here](#). Nonetheless, some key differences with the format supported by `curtin` have been introduced:

- Subiquity supports an alternative format for the `primary` section, allowing to configure a list of candidate primary mirrors. During installation, subiquity will automatically test the specified mirrors and select the first one that seems usable. This new behavior is only activated when the `primary` section is wrapped in the `mirror-selection` section.
- The `fallback` key controls what subiquity should do if no primary mirror is usable.
- The `geoip` key controls whether a geoip lookup is done to determine the correct country mirror.

The default is:

```
apt:
  preserve_sources_list: false
  mirror-selection:
    primary:
      - country-mirror
      - arches: [i386, amd64]
        uri: "http://archive.ubuntu.com/ubuntu"
      - arches: [s390x, arm64, armhf, powerpc, ppc64el, riscv64]
        uri: "http://ports.ubuntu.com/ubuntu-ports"
  fallback: abort
  geoip: true
```

mirror-selection

if the `primary` section is contained within the `mirror-selection` section, the automatic mirror selection is enabled. This is the default in new installations.

primary (when placed inside the mirror-selection section):

type: custom, see below

In the new format, the `primary` section expects a list of mirrors, which can be expressed in two different ways:

- the special value `country-mirror`
- a mapping with the following keys:
 - `uri`: the URI of the mirror to use, e.g., “<http://fr.archive.ubuntu.com/ubuntu>”
 - `arches`: an optional list of architectures supported by the mirror. By default, this list contains the current CPU architecture.

fallback

type: string (enumeration)

default: abort

Controls what subiquity should do if no primary mirror is usable.

Supported values are:

- `abort` -> abort the installation
- `offline-install` -> revert to an offline installation
- `continue-anyway` -> attempt to install the system anyway (not recommended, the installation will certainly fail)

geoip

type: boolean

default:: true

If `geoip` is true and one of the candidate primary mirrors has the special value `country-mirror`, a request is made to <https://geoip.ubuntu.com/lookup>. Subiquity then sets the mirror URI to <http://CC.archive.ubuntu.com/ubuntu> (or similar for ports) where CC is the country code returned by the lookup. If this section is not interactive, the request is timed out after 10 seconds.

If the legacy behavior (i.e., without `mirror-selection`) is in use, the `geoip` request is made if the mirror to be used is the default, and its URI ends up getting replaced by the proper country mirror URI.

If you just want to specify a mirror, you can use a configuration like this:

```
apt:
  mirror-selection:
    primary:
      - uri: YOUR_MIRROR_GOES_HERE
```

- country-mirror
- uri: <http://archive.ubuntu.com/ubuntu>

To add a ppa:

```
apt:
  sources:
    curtin-ppa:
      source: ppa:curtin-dev/test-archive
```

storage

type: mapping, see below

default: use “lvm” layout in a single disk system, no default in a multiple disk system

can be interactive: yes

Storage configuration is a complex topic and the description of the desired configuration in the autoinstall file can also be complex. The installer supports “layouts”, simple ways of expressing common configurations.

Supported layouts

The two supported layouts at the time of writing are “lvm” and “direct”.

```
storage:
  layout:
    name: lvm
storage:
  layout:
    name: direct
```

By default these will install to the largest disk in a system, but you can supply a match spec (see below) to indicate which disk to use:

```
storage:
  layout:
    name: lvm
    match:
      serial: CT*
storage:
  layout:
    name: disk
    match:
      ssd: yes
```

(you can just say “match: {}” to match an arbitrary disk)

When using the “lvm” layout, LUKS encryption can be enabled by supplying a password.

```
storage:
  layout:
    name: lvm
    password: LUKS_PASSPHRASE
```

The default is to use the lvm layout.

sizing-policy

The lvm layout will, by default, attempt to leave room for snapshots and further expansion. A sizing-policy key may be supplied to control this behavior.

type: string (enumeration)

default: scaled

Supported values are:

- **scaled** -> adjust space allocated to the root LV based on space available to the VG
- **all** -> allocate all remaining VG space to the root LV

The scaling system is currently as follows:

- Less than 10 GiB: use all remaining space for root filesystem

- Between 10-20 GiB: 10 GiB root filesystem
- Between 20-200 GiB: use half of remaining space for root filesystem
- Greater than 200 GiB: 100 GiB root filesystem

Action-based config

For full flexibility, the installer allows storage configuration to be done using a syntax which is a superset of that supported by curtin, described at <https://curtin.readthedocs.io/en/latest/topics/storage.html>.

If the “layout” feature is used to configure the disks, the “config” section will not be used.

As well as putting the list of actions under the ‘config’ key, the `grub` and `swap` curtin config items can be put here. So a storage section might look like:

```
storage:
  swap:
    size: 0
  config:
    - type: disk
      id: disk0
      serial: ADATA_SX8200PNP_XXXXXXXXXXXX
    - type: partition
      ...
```

The extensions to the curtin syntax are around disk selection and partition/logical volume sizing.

Disk selection extensions

Curtin supported identifying disks by serial (e.g. `Crucial_CT512MX100SSD1_14250C57FECE`) or by path (e.g. `/dev/sdc`) and the server installer supports this as well. The installer additionally supports a “match spec” on a disk action that supports more flexible matching.

The actions in the storage config are processed in the order they are in the autoinstall file. Any disk action is assigned a matching disk – chosen arbitrarily from the set of unassigned disks if there is more than one, and causing the installation to fail if there is no unassigned matching disk.

A match spec supports the following keys:

- `model: foo`: matches a disk where `ID_VENDOR=foo` in udev, supporting globbing
- `path: foo`: matches a disk where `DEVPATH=foo` in udev, supporting globbing (the globbing support distinguishes this from specifying `path: foo` directly in the disk action)
- `serial: foo`: matches a disk where `ID_SERIAL=foo` in udev, supporting globbing (the globbing support distinguishes this from specifying `serial: foo` directly in the disk action)
- `ssd: yes|no`: matches a disk that is or is not an SSD (vs a rotating drive)
- `size: largest|smallest`: take the largest or smallest disk rather than an arbitrary one if there are multiple matches (support for `smallest` added in version 20.06.1)

A special sort of key is `install-media: yes`, which will take the disk the installer was loaded from (the `ssd` and `size` selectors will never return this disk). If installing to the install media, care obviously needs to be taken to not overwrite the installer itself!

So for example, to match an arbitrary disk it is simply:

```
- type: disk
  id: disk0
```

To match the largest SSD:

```
- type: disk
  id: big-fast-disk
  match:
    ssd: yes
    size: largest
```

To match a Seagate drive:

```
- type: disk
  id: data-disk
  match:
    model: Seagate
```

Partition/logical volume extensions

The size of a partition or logical volume in curtin is specified as a number of bytes. The autoinstall config is more flexible:

- You can specify the size using the “1G”, “512M” syntax supported in the installer UI.
 - You can specify the size as a percentage of the containing disk (or RAID), e.g. “50%”.
 - For the last partition specified for a particular device, you can specify the size as “-1” to indicate that the partition should fill the remaining space.
- ```
- type: partition
 id: boot-partition
 device: root-disk
 size: 10%
- type: partition
 id: root-partition
 size: 20G
- type: partition
 id: data-partition
 device: root-disk
 size: -1
```

## identity

**type:** mapping, see below

**default:** no default

**can be interactive:** yes

Configure the initial user for the system. This is the only config key that must be present (unless the [user-data section](#) is present, in which case it is optional).

A mapping that can contain keys, all of which take string values:

### realname

The real name for the user. This field is optional.

### username

The user name to create.

### hostname

The hostname for the system.

### password

The password for the new user, encrypted. This is required for use with `sudo`, even if SSH access is configured.

The crypted password string must conform to what `passwd` expects. Depending on the special characters in the password hash, quoting may be required, so it's safest to just always include the quotes around the hash.

Several tools can generate the crypted password, such as `mkpasswd` from the `whois` package, or `openssl passwd`.

Example:

```
identity:
```

```
 realname: 'Ubuntu User'
```

```
 username: ubuntu
```

```
 password: '6wdAcoXrU039hKYPd$508Qvbe70bUnxoj15DRckzC3q07edjH0VV7BPNRDYK4QR8ofJaEEF2heacn0QgD.f8p08SNp83XNdWG6tocBM'
```

```
 hostname: ubuntu
```

## active-directory

**type:** mapping, see below

**default:** no default

**can be interactive:** yes

Accepts data required to join the target system in an Active Directory domain.

A mapping that can contain keys, all of which take string values:

### **admin-name**

A domain account name with privilege to perform the join operation. That account's password will be requested during runtime.

### **domain-name**

The Active Directory domain to join.

### **ubuntu-pro**

**type:** mapping, see below

**default:** see below

**can be interactive:** yes

### **token**

**type:** string

**default:** no token

A contract token to attach to an existing Ubuntu Pro subscription.

### **ssh**

**type:** mapping, see below

**default:** see below

**can be interactive:** yes

Configure SSH for the installed system. A mapping that can contain keys:

### **install-server**

**type:** boolean

**default:** false

Whether to install OpenSSH server in the target system.

### **authorized-keys**

**type:** list of strings

**default:** []

A list of SSH public keys to install in the initial user's account.

### **allow-pw**

**type:** boolean

**default:** true if `authorized_keys` is empty, false otherwise

### **codecs**

**type:** mapping, see below

**default:** see below

**can be interactive:** no

Configure whether common restricted packages (including codecs) from [multiverse] should be installed.

### **install**

**type:** boolean

**default:** false

Whether to install the `ubuntu-restricted-addons` package.

### **drivers**

**type:** mapping, see below

**default:** see below

**can be interactive:** yes

## install

**type:** boolean  
**default:** false

Whether to install the available third-party drivers.

## snaps

**type:** list  
**default:** install no extra snaps  
**can be interactive:** yes

A list of snaps to install. Each snap is represented as a mapping with required `name` and optional `channel` (defaulting to `stable`) and `classic` (defaulting to `false`) keys. For example:

```
snaps:
 - name: etcd
 channel: edge
 classic: false
```

## debconf-selections

**type:** string  
**default:** no config  
**can be interactive:** no

The installer will update the target with debconf set-selection values. Users will need to be familiar with the package debconf options.

## packages

**type:** list  
**default:** no packages  
**can be interactive:** no

A list of packages to install into the target system. More precisely, a list of strings to pass to “`apt-get install`”, so this includes things like task selection (`dns-server^`) and installing particular versions of a package (`my-package=1-1`).

## kernel

**type:** mapping (mutually exclusive), see below  
**default:** default kernel  
**can be interactive:** no

Which kernel gets installed. Either the name of the package or the name of the flavor must be specified.

## package

**type:** string  
The name of the package, e.g., `linux-image-5.13.0-40-generic`

## flavor

**type:** string  
The flavor of the kernel, e.g., `generic` or `hwe`.

## timezone

**type:** string  
**default:** no timezone  
**can be interactive:** no

The timezone to configure on the system. The special value “`geoup`” can be used to query the timezone automatically over the network.

## updates

**type:** string (enumeration)

**default:** security

**can be interactive:** no

The type of updates that will be downloaded and installed after the system install.

Supported values are:

- **security** -> download and install updates from the -security pocket
- **all** -> also download and install updates from the -updates pocket

## shutdown

**type:** string (enumeration)

**default:** reboot

**can be interactive:** no

Request the system to power off or reboot automatically after the installation has finished.

Supported values are:

- **reboot**
- **poweroff**

## late-commands

**type:** [command list](#)

**default:** no commands

**can be interactive:** no

Shell commands to run after the install has completed successfully and any updates and packages installed, just before the system reboots. They are run in the installer environment with the installed system mounted at `/target`. You can run `curtin in-target -- $shell_command` (with the version of subiquity released with 20.04 GA you need to specify this as `curtin in-target --target=/target -- $shell_command`) to run in the target system (similar to how plain `in-target` can be used in `d-i preseed/late_command`).

## error-commands

**type:** [command list](#)

**default:** no commands

**can be interactive:** no

Shell commands to run after the install has failed. They are run in the installer environment, and the target system (or as much of it as the installer managed to configure) will be mounted at `/target`. Logs will be available at `/var/log/installer` in the live session.

## reporting

**type:** mapping

**default:** type: print which causes output on `tty1` and any configured serial consoles

**can be interactive:** no

The installer supports reporting progress to a variety of destinations. Note that this section is ignored if there are any [interactive sections](#); it only applies to fully automated installs.

The config, and indeed the implementation, is 90% the same as [that used by curtin](#).

Each key in the reporting mapping in the config defines a destination, where the **type** sub-key is one of:

### The rsyslog reporter does not yet exist

- **print:** print progress information on `tty1` and any configured serial console. There is no other configuration.
- **rsyslog:** report progress via rsyslog. The **destination** key specifies where to send output.
- **webhook:** report progress via POSTing JSON reports to a URL. Accepts the same configuration as [curtin](#).
- **none:** do not report progress. Only useful to inhibit the default output.

Examples:

The default configuration is:

```
reporting:
 builtin:
 type: print
```

Report to rsyslog:

```
reporting:
 central:
 type: rsyslog
 destination: @192.168.0.1
```

Suppress the default output:

```
reporting:
 builtin:
 type: none
```

Report to a curtin-style webhook:

```
reporting:
 hook:
 type: webhook
 endpoint: http://example.com/endpoint/path
 consumer_key: "ck_foo"
 consumer_secret: "cs_foo"
 token_key: "tk_foo"
 token_secret: "tk_secret"
 level: INFO
```

## user-data

```
type: mapping
default: {}
can be interactive: no
```

Provide cloud-init user data which will be merged with the user data the installer produces. If you supply this, you don't need to supply an [identity section](#) (but then it's your responsibility to make sure that you can log into the installed system!).

## Introduction

The server installer validates the provided autoinstall config against a [JSON schema](#).

## How the config is validated

Although the schema is presented below as a single document, and if you want to pre-validate your config you should validate it against this document, the config is not actually validated against this document at run time. What happens instead is that some sections are loaded, validated, and applied first, before all other sections are validated. In detail:

1. The reporting section is loaded, validated and applied.
2. The error commands are loaded and validated.
3. The early commands are loaded and validated.
4. The early commands, if any, are run.
5. The config is reloaded, and now all sections are loaded and validated.

This is so that validation errors in most sections can be reported via the reporting and error-commands configuration, as all other errors are.

## Schema

The [JSON schema](#) for autoinstall data is as follows:

```
{
 "type": "object",
 "properties": {
 "version": {
 "type": "integer",
 "minimum": 1,
 "maximum": 1
 }
 }
}
```



```

},
"early-commands": {
 "type": "array",
 "items": {
 "type": [
 "string",
 "array"
],
 "items": {
 "type": "string"
 }
 }
},
"reporting": {
 "type": "object",
 "additionalProperties": {
 "type": "object",
 "properties": {
 "type": {
 "type": "string"
 }
 }
 },
 "required": [
 "type"
],
 "additionalProperties": true
},
"error-commands": {
 "type": "array",
 "items": {
 "type": [
 "string",
 "array"
],
 "items": {
 "type": "string"
 }
 }
},
"user-data": {
 "type": "object"
},
"packages": {
 "type": "array",
 "items": {
 "type": "string"
 }
},
"debconf-selections": {
 "type": "string"
},
"locale": {
 "type": "string"
},
"refresh-installer": {
 "type": "object",
 "properties": {
 "update": {
 "type": "boolean"
 },
 "channel": {
 "type": "string"
 }
 }
}

```

```

 }
 },
 "additionalProperties": false
},
"kernel": {
 "type": "object",
 "properties": {
 "package": {
 "type": "string"
 },
 "flavor": {
 "type": "string"
 }
 }
},
"oneOf": [
 {
 "type": "object",
 "required": [
 "package"
]
 },
 {
 "type": "object",
 "required": [
 "flavor"
]
 }
]
},
"keyboard": {
 "type": "object",
 "properties": {
 "layout": {
 "type": "string"
 },
 "variant": {
 "type": "string"
 },
 "toggle": {
 "type": [
 "string",
 "null"
]
 }
 },
 "required": [
 "layout"
],
 "additionalProperties": false
},
"source": {
 "type": "object",
 "properties": {
 "search_drivers": {
 "type": "boolean"
 },
 "id": {
 "type": "string"
 }
 }
},
"network": {
 "oneOf": [

```

```

{
 "type": "object",
 "properties": {
 "version": {
 "type": "integer",
 "minimum": 2,
 "maximum": 2
 },
 "ethernets": {
 "type": "object",
 "properties": {
 "match": {
 "type": "object",
 "properties": {
 "name": {
 "type": "string"
 },
 "macaddress": {
 "type": "string"
 },
 "driver": {
 "type": "string"
 }
 }
 },
 "additionalProperties": false
 }
 },
 "wifis": {
 "type": "object",
 "properties": {
 "match": {
 "type": "object",
 "properties": {
 "name": {
 "type": "string"
 },
 "macaddress": {
 "type": "string"
 },
 "driver": {
 "type": "string"
 }
 }
 },
 "additionalProperties": false
 }
 },
 "bridges": {
 "type": "object"
 },
 "bonds": {
 "type": "object"
 },
 "tunnels": {
 "type": "object"
 },
 "vlans": {
 "type": "object"
 }
 },
 "required": [
 "version"
]
}

```

```

]
},
{
 "type": "object",
 "properties": {
 "network": {
 "type": "object",
 "properties": {
 "version": {
 "type": "integer",
 "minimum": 2,
 "maximum": 2
 },
 "ethernets": {
 "type": "object",
 "properties": {
 "match": {
 "type": "object",
 "properties": {
 "name": {
 "type": "string"
 },
 "macaddress": {
 "type": "string"
 },
 "driver": {
 "type": "string"
 }
 }
 },
 "additionalProperties": false
 }
 },
 "wifis": {
 "type": "object",
 "properties": {
 "match": {
 "type": "object",
 "properties": {
 "name": {
 "type": "string"
 },
 "macaddress": {
 "type": "string"
 },
 "driver": {
 "type": "string"
 }
 }
 },
 "additionalProperties": false
 }
 },
 "bridges": {
 "type": "object"
 },
 "bonds": {
 "type": "object"
 },
 "tunnels": {
 "type": "object"
 },
 "vlans": {

```

```

 "type": "object"
 }
 },
 "required": [
 "version"
]
 }
},
"required": [
 "network"
]
}
]
},
"ubuntu-pro": {
 "type": "object",
 "properties": {
 "token": {
 "type": "string",
 "minLength": 24,
 "maxLength": 30,
 "pattern": "^C[1-9A-HJ-NP-Za-km-z]+$",
 "description": "A valid token starts with a C and is followed by 23 to 29 Base58 characters.\nSee https://pkg
 }
 }
},
"ubuntu-advantage": {
 "type": "object",
 "properties": {
 "token": {
 "type": "string",
 "minLength": 24,
 "maxLength": 30,
 "pattern": "^C[1-9A-HJ-NP-Za-km-z]+$",
 "description": "A valid token starts with a C and is followed by 23 to 29 Base58 characters.\nSee https://pkg
 }
 },
 "deprecated": true,
 "description": "Compatibility only - use ubuntu-pro instead"
},
"proxy": {
 "type": [
 "string",
 "null"
],
 "format": "uri"
},
"apt": {
 "type": "object",
 "properties": {
 "preserve_sources_list": {
 "type": "boolean"
 },
 "primary": {
 "type": "array"
 },
 "mirror-selection": {
 "type": "object",
 "properties": {
 "primary": {
 "type": "array",
 "items": {
 "anyOf": [

```

```

 {
 "type": "string",
 "const": "country-mirror"
 },
 {
 "type": "object",
 "properties": {
 "uri": {
 "type": "string"
 },
 "arches": {
 "type": "array",
 "items": {
 "type": "string"
 }
 }
 },
 "required": [
 "uri"
]
 }
]
}
}
},
"geoup": {
 "type": "boolean"
},
"sources": {
 "type": "object"
},
"disable_components": {
 "type": "array",
 "items": {
 "type": "string",
 "enum": [
 "universe",
 "multiverse",
 "restricted",
 "contrib",
 "non-free"
]
 }
},
"preferences": {
 "type": "array",
 "items": {
 "type": "object",
 "properties": {
 "package": {
 "type": "string"
 },
 "pin": {
 "type": "string"
 },
 "pin-priority": {
 "type": "integer"
 }
 }
 },
 "required": [
 "package",
 "pin",

```

```

 "pin-priority"
]
 }
 },
 "fallback": {
 "type": "string",
 "enum": [
 "abort",
 "continue-anyway",
 "offline-install"
]
 }
},
"storage": {
 "type": "object"
},
"identity": {
 "type": "object",
 "properties": {
 "realname": {
 "type": "string"
 },
 "username": {
 "type": "string"
 },
 "hostname": {
 "type": "string"
 },
 "password": {
 "type": "string"
 }
 },
 "required": [
 "username",
 "hostname",
 "password"
],
 "additionalProperties": false
},
"ssh": {
 "type": "object",
 "properties": {
 "install-server": {
 "type": "boolean"
 },
 "authorized-keys": {
 "type": "array",
 "items": {
 "type": "string"
 }
 },
 "allow-pw": {
 "type": "boolean"
 }
 }
},
"snaps": {
 "type": "array",
 "items": {
 "type": "object",
 "properties": {
 "name": {

```

```

 "type": "string"
 },
 "channel": {
 "type": "string"
 },
 "classic": {
 "type": "boolean"
 }
},
"required": [
 "name"
],
"additionalProperties": false
}
},
"codecs": {
 "type": "object",
 "properties": {
 "install": {
 "type": "boolean"
 }
 }
},
"drivers": {
 "type": "object",
 "properties": {
 "install": {
 "type": "boolean"
 }
 }
},
"timezone": {
 "type": "string"
},
"updates": {
 "type": "string",
 "enum": [
 "security",
 "all"
]
},
"late-commands": {
 "type": "array",
 "items": {
 "type": [
 "string",
 "array"
],
 "items": {
 "type": "string"
 }
 }
},
"shutdown": {
 "type": "string",
 "enum": [
 "reboot",
 "poweroff"
]
}
},
"required": [
 "version"

```



```

],
"additionalProperties": true
}

```

## Regeneration

The schema above can be regenerated by running “make schema” in a Subiquity source checkout.

This non-interactive installation uses ‘autoinstall’, which can be considered the successor to the Debian installer (d-i) and preseed on Ubuntu. This is a detailed step-by-step guide, including output and logs (which are partially a bit shortened, as indicated by ‘...’, to limit the size of this document).

The example z/VM guest here uses a direct-access storage device (DASD) and is connected to a regular (non-VLAN) network.

For a zFCP and a VLAN network example, please see the [non-interactive IBM LPAR \(s390x\) installation using autoinstall](#) guide.

- Start with the preparation of the (FTP) install server (if it doesn’t already exist).

```

user@local:~$ ssh admin@installserver.local
admin@installserver:~$ mkdir -p /srv/ftp/ubuntu-daily-live-server-20.04
admin@installserver:~$ wget http://cdimage.ubuntu.com/ubuntu-server/focal/daily-live/current/focal-live-server-s390x.iso --directory-prefix=/srv/ftp/ubuntu-daily-live-server-20.04
--2020-06-26 12:18:48-- http://cdimage.ubuntu.com/ubuntu-server/focal/daily-live/current/focal-live-server-s390x.iso
Resolving cdimage.ubuntu.com (cdimage.ubuntu.com)... 2001:67c:1560:8001::1d, 2001:67c:1360:8001::28, 2001:67c:1360:8001::1e
...
Connecting to cdimage.ubuntu.com (cdimage.ubuntu.com)|2001:67c:1560:8001::1d|:80... connected.
HTTP request sent, awaiting response... 200 OK
Length: 700952576 (668M) [application/x-iso9660-image]
Saving to: ‘focal-live-server-s390x.iso’

focal-live-server-s 100%[=====] 668.48M 2.73MB/s in 4m 54s

2020-06-26 12:23:42 (2.27 MB/s) - ‘focal-live-server-s390x.iso’ saved [700952576/700952576]
admin@installserver:~$

```

- The ISO image needs to be extracted now. Since files in the boot folder need to be modified, loopback mount is not an option here:

```

admin@installserver:~$ cd /srv/ftp/ubuntu-daily-live-server-20.04
admin@installserver:/srv/ftp/ubuntu-daily-live-server-20.04$ mkdir iso
admin@installserver:/srv/ftp/ubuntu-daily-live-server-20.04$ sudo mount -o loop ./focal-live-server-s390x.iso ./iso
[sudo] password for admin:
mount: /home/user/iso-test/iso: WARNING: device write-protected, mounted read-only.
admin@installserver:/srv/ftp/ubuntu-daily-live-server-20.04$ ls -l
total 684530
-rw-rw-r-- 1 user user 700952576 Jun 26 10:12 focal-live-server-s390x.iso
dr-xr-xr-x 10 root root 2048 Jun 26 10:12 iso
admin@installserver:/srv/ftp/ubuntu-daily-live-server-20.04$

```

- Now make sure an FTP server is running in the *installserver* with */srv/ftp* as ftp-server root (as used in this example).
- Next, prepare an *autoinstall* (HTTP) server. This hosts the configuration data for the non-interactive installation.

```

admin@installserver:/srv/ftp/ubuntu-daily-live-server-20.04$ mkdir -p /srv/www/autoinstall/zvmguest
admin@installserver:/srv/ftp/ubuntu-daily-live-server-20.04$ cd /srv/www/autoinstall/zvmguest
admin@installserver:/srv/www/autoinstall/zvmguest$
admin@installserver:/srv/www/autoinstall/zvmguest$ echo "instance-id: $(uuidgen || openssl rand -base64 8)" > meta-data
admin@installserver:/srv/www/autoinstall/zvmguest$ cat meta-data
instance-id: 2c2215fb-6a38-417f-b72f-376b1cc44f01
admin@installserver:/srv/www/autoinstall/zvmguest$

```

```

admin@installserver:/srv/www/autoinstall/zvmguest$ vi user-data
admin@installserver:/srv/www/autoinstall/zvmguest$ cat user-data
#cloud-config
autoinstall:
 version: 1
 refresh-installer:
 update: yes
 reporting:
 builtin:
 type: print
 apt:
 preserve_sources_list: false
 primary:
 - arches: [amd64, i386]
 uri: http://archive.ubuntu.com/ubuntu
 - arches: [default]
 uri: http://ports.ubuntu.com/ubuntu-ports
 keyboard:
 layout: en
 variant: us
 locale: en_US
 identity:
 hostname: zvmguest
 password:
"6ebJ1f8wxED22bTL4F46P0"
 username: ubuntu
 user-data:
 timezone: America/Boston
 users:
 - name: ubuntu
 password:
"6KwuxED22bTL4F46P0"
 lock_passwd: false
 early-commands:
 - touch /tmp/lets_activate_the_s390x_devices
 - chzdev dasd -e 1f00
 - touch /tmp/s390x_devices_activation_done
 network:
 version: 2
 ethernets:
 enc600:
 addresses: [10.11.12.23/24]
 gateway4: 10.11.12.1
 nameservers:
 addresses: [10.11.12.1]
 ssh:
 install-server: true
 allow-pw: true
 authorized-keys: ['ssh-rsa meQwtZ user@workstation # ssh-import-id lp:user']
admin@installserver:~$

```

- For s390x installations, the early-commands section is the interesting part:

```

early-commands:
 - touch /tmp/lets_activate_the_s390x_devices
 - chzdev dasd -e 1f00
 - touch /tmp/s390x_devices_activation_done

```

The first and last early-commands are optional; they only frame and indicate the real s390x command activation.

In this particular example a single DASD ECKD disk with the address 1f00 is enabled. zFCP disk storage can be enabled via their host (host-bus-adapters) addresses, for example *e000* (chzdev zfcpl -e e000) and *e100* (chzdev zfcpl -e e000). These have certain Logical Unit Numbers (LUNs) assigned, which are all automatically discovered and activated by chzdev zfcpl-lun -e --online. Activation of a qeth device would look like this: chzdev qeth -e 0600.

- For more details about the autoinstall config options, please have a look at the [autoinstall reference](#) and [autoinstall schema](#) page.
- Now make sure a HTTP server is running with /srv/www as web-server root (in this particular example).
- Log in to your z/VM system using your preferred 3270 client – for example x3270 or c3270.
- Transfer the installer kernel, initrd, parmfile and exec file to the z/VM system that is used for the installation. Put these files (for example) on File Mode (Fm) A (a.k.a disk A):

```
listfiles
UBUNTU EXEC A1
KERNEL UBUNTU A1
INITRD UBUNTU A1
PARMFILE UBUNTU A1
```

- Now specify the necessary autoinstall parameters in the parmfile:

```
xedit PARMFILE UBUNTU A
 PARMFILE UBUNTU 01 F 80 Trunc=80 Size=3 Line=0 Col=1 Alt=0
00000 * * * Top of File * * *
00001 ip=10.11.12.23::10.11.12.1:255.255.255.0:zvmguest:enc600:none:10.11.12.1
00002 url=ftp://installserver.local:21/ubuntu-daily-live-server-20.04/focal-live-ser
ve-ser
00003 ver=s390x.iso autoinstall ds=nocloud-net;s=http://installserver.local:80
00004 /autoinstall/zvmguest/ --- quiet
00005 * * * End of File * * *
```

**Note:**

In case of any issues hitting the 80-character-per-line limit of the file, you can write parameters across two lines as long as there are no unwanted white spaces. To view all 80 characters in one line, disable the prefix area on the left. “prefix off | on” will be your friend – use it in the command area.

- You can now start the z/VM installation by executing the UBUNTU REXX script with UBUNTU.
- Now monitor the initial program load (IPL) – a.k.a. the boot-up process – of the install system. This is quite crucial, because during this process a temporary installation password is generated and displayed. The line(s) look similar to this:

```
...
|37.487141| cloud-init-1873|: Set the following 'random' passwords
|37.487176| cloud-init-1873|: installer: **i7UFdP8fhiVVMme3qqH8**
...
```

This password is needed for remotely connecting to the installer via SSH in the next step.

- So, start the REXX script:

```
UBUNTU
00: 0000004 FILES PURGED
00: RDR FILE 1254 SENT FROM zvmguest PUN WAS 1254 RECS 102K CPY
001 A NOHOLD NO
KEEP
00: RDR FILE 1258 SENT FROM zvmguest PUN WAS 1258 RECS 0003 CPY
001 A NOHOLD NO
KEEP
00: RDR FILE 1262 SENT FROM zvmguest PUN WAS 1262 RECS 303K CPY
001 A NOHOLD NO
KEEP
00: 0000003 FILES CHANGED
00: 0000003 FILES CHANGED
01: HCPGSP2627I The virtual machine is placed in CP mode due to a SIGP
initial C
PU reset from CPU 00.
02: HCPGSP2627I The virtual machine is placed in CP mode due to a SIGP
initial C
PU reset from CPU 00.
03: HCPGSP2627I The virtual machine is placed in CP mode due to a SIGP
initial C
```

```
PU reset from CPU 00.
- 0.403380| Initramps unpacking failed: Decoding failed
ln: /tmp/mountroot-fail-hooks.d//scripts/init-premount/lvm2: No such file or directory
QETH device 0.0.0600:0.0.0601:0.0.0602 configured
IP-Config: enc600 hardware address 02:28:0b:00:00:51 mtu 1500
IP-Config: enc600 guessed broadcast address 10.11.12.255
IP-Config: enc600 complete:
address: 10.11.12.23 broadcast: 10.210.210.255 netmask: 255.255.255.0
```

```
gateway: 10.11.12.1 dns0 : 10.11.12.1 dns1 : 0.0.0.0
```

```
host : zvmguest
rootserver: 0.0.0.0 rootpath:
filename :
```

```
Connecting to installserver.local:21 (10.11.12.2:21)
```

```
focal-live-server-s3 2% ! ! 15.2M 0:00:48 ETA
focal-live-server-s3 16% !***** ! 126M 0:00:09 ETA
focal-live-server-s3 31% !***** ! 236M 0:00:06 ETA
focal-live-server-s3 46% !***** ! 347M 0:00:04 ETA
focal-live-server-s3 60% !***** ! 456M 0:00:03 ETA
focal-live-server-s3 74% !***** ! 563M 0:00:02 ETA
focal-live-server-s3 88% !***** ! 667M 0:00:00 ETA
focal-live-server-s3 100% !***** ! 752M 0:00:00 ETA
```

```
mount: mounting /cow on /root/cow failed: No such file or directory
```

```
Connecting to plymouth: Connection refused
```

```
passwd: password expiry information changed.
```

```
- 16.748137| /dev/loop3: Can't open blockdev
- 17.908156| systemd-1|: Failed unmounting /cdrom.
- -0;1;31mFAILED -0m| Failed unmounting -0;1;39m/cdrom -0m.
- -0;32m OK -0m| Listening on -0;1;39mJournal Socket -0m.
Mounting -0;1;39mHuge Pages File System -0m...
Mounting -0;1;39mPOSIX Message Queue File System -0m...
Mounting -0;1;39mKernel Debug File System -0m...
Starting -0;1;39mJournal Service -0m...
```

```
...
```

```
[61.190916] cloud-init[2076]: Cloud-init v. 20.1-10-g71af48df-0ubuntu5 running 'modules:final' at Fri, 26 Jun 2020 11:02:01 +0000. Up 61.09 seconds.
```

```
[61.191002] cloud-init[2076]: ci-info: no authorized SSH keys fingerprints found for user installer.
```

```
[61.191071] cloud-init[2076]: Cloud-init v. 20.1-10-g71af48df-0ubuntu5 finished at Fri, 26 Jun 2020 11:02:01 +0000
```

```
Datasource DataSourceNoCloudNet [seed=cmdline, /var/lib/cloud/seed/nocloud, http://installserver.local:80/autoinstall/zvmguest/] [dsmode=net]. Up 61.18 seconds
```

```
[61.191136] cloud-init[2076]: Welcome to Ubuntu Server Installer!
```

```
[61.191202] cloud-init[2076]: Above you will find SSH host keys and a random password set for the `installer` user. You can use these credentials to ssh-in and complete the installation. If you provided SSH keys in the cloud-init datasource, they were also provisioned to the installer user.
```

```
[61.191273] cloud-init[2076]: If you have access to the graphical console, like TTY1 or HMC ASCII terminal you can complete the installation there too.
```

It is possible to connect to the installer over the network, which might allow the use of a more capable terminal.

To connect, SSH to installer@10.11.12.23.

The password you should use is 'i7UFdP8fhiVVMme3qqH8'.

The host key fingerprints are:

RSA SHA256:rBXLeUke3D4gKdsruKEajHjocxc9hr3PI

```
ECDSA SHA256:KZZYFswtKxFXWQPuQS9Qp0BUoS6RHswis
ED25519 SHA256:s+5tZfagx0zffc6gYRGW3t1KcBH6f+Vt0
```

```
Ubuntu 20.04 LTS ubuntu-server sclp_line0
```

- At short notice, you can even log in to the system with the user 'installer' and the temporary password that was given at the end of the boot-up process (see above) of the installation system:

```
user@workstation:~$ ssh installer@zvmguest
The authenticity of host 'zvmguest (10.11.12.23)' can't be established.
ECDSA key fingerprint is SHA256:0/dU/D8jJAEGQcbqKGE9La24IRxUPLpzzs5li9F6Vvk.
Are you sure you want to continue connecting (yes/no/[fingerprint])? yes
Warning: Permanently added 'zvmguest,10.11.12.23' (ECDSA) to the list of known hosts.
installer@zvmguest's password:
Welcome to Ubuntu 20.04 LTS (GNU/Linux 5.4.0-37-generic s390x)
```

```
* Documentation: https://help.ubuntu.com
* Management: https://landscape.canonical.com
* Support: https://ubuntu.com/pro
```

```
System information as of Fri Jun 26 11:08:18 UTC 2020
```

```
System load: 1.25 Memory usage: 4% Processes: 192
Usage of /home: unknown Swap usage: 0% Users logged in: 0
```

```
0 updates can be installed immediately.
0 of these updates are security updates.
```

```
The list of available updates is more than a week old.
To check for new updates run: sudo apt update
```

```
The programs included with the Ubuntu system are free software;
the exact distribution terms for each program are described in the
individual files in /usr/share/doc/*/copyright.
```

```
Ubuntu comes with ABSOLUTELY NO WARRANTY, to the extent permitted by
applicable law.
```

```
the installer running on /dev/tty1 will perform the autoinstall
```

```
press enter to start a shell
```

- Please note that it informs you about a currently-running autoinstall process:  
the installer running on /dev/tty1 will perform the autoinstall
- Nevertheless, we can quickly check some things – although, only until the autoinstall process is finished and the post-install reboot has been triggered:

```
root@ubuntu-server:/# ls -l /tmp/lets_activate_the_s390x_devices
-rw-r--r-- 1 root root 0 Jun 26 11:08 /tmp/lets_activate_the_s390x_devices
-rw-r--r-- 1 root root 0 Jun 26 11:09 /tmp/s390x_devices_activation_done
```

```
root@ubuntu-server:/# lszdev | grep yes
dasd-eckd 0.0.1f00 yes yes
qeth 0.0.0600:0.0.0601:0.0.0602 yes no enc600
root@ubuntu-server:/#
```

- If you wait long enough, you'll see that the remote session gets closed:  
root@ubuntu-server:/# Connection to zvmguest closed by remote host.  
Connection to zvmguest closed.  
user@workstation:~\$
- As well as at the console:

ubuntu-server login:

```
[[0;1;31mFAILED[0m] Failed unmounting [0;1;39m/cdrom[0m.
[169.161139] sd-umoun[15600]: Failed to unmount /oldroot: Device or resource busy
[169.161550] sd-umoun[15601]: Failed to unmount /oldroot/cdrom: Device or resource busy
[169.168118] shutdown[1]: Failed to finalize file systems, loop devices, ignoring
Total: 282 Selected: 0
```

Command:

- ...and that the post-install reboot got triggered:

Message

```
Mounting [0;1;39mKernel Configuration File System[0m...
Starting [0;1;39mApply Kernel Variables[0m...
[[0;32m OK [0m] Finished [0;1;39mRemount Root and Kernel File Systems[0m.
[[0;32m OK [0m] Finished [0;1;39mUncomplicated firewall[0m.
[[0;32m OK [0m] Mounted [0;1;39mFUSE Control File System[0m.
[[0;32m OK [0m] Mounted [0;1;39mKernel Configuration File System[0m.
...
[35.378928] cloud-init[2565]: Cloud-init v. 20.1-10-g71af48df-0ubuntu5 runnin
g 'modules:final' at Fri, 26 Jun 2020 11:10:44 +0000. Up 35.29 seconds.
[35.378978] cloud-init[2565]: Cloud-init v. 20.1-10-g71af48df-0ubuntu5 finish
ed at Fri, 26 Jun 2020 11:10:44 +0000. Datasource DataSourceNone. Up 35.37 seconds
[35.379008] cloud-init[2565]: 2020-06-26 11:10:44,359 - cc_final_message.py[W
ARNING]: Used fallback datasource
[[0;32m OK [0m] Finished [0;1;39mExecute cloud user/final scripts[0m.
[[0;32m OK [0m] Reached target [0;1;39mCloud-init target[0m.
```

zvmguest login:

- With the completion of the reboot the autoinstall is finished and the z/VM guest is ready to use:

```
user@workstation:~$ ssh-keygen -f "/home/user/.ssh/known_hosts" -R "zvmguest"
Host zvmguest found: line 163
/home/user/.ssh/known_hosts updated.
Original contents retained as /home/user/.ssh/known_hosts.old
user@workstation:~$ ssh ubuntu@zvmguest
The authenticity of host 'zvmguest (10.11.12.23)' can't be established.
ECDSA key fingerprint is SHA256:iGtCAReg+ZnoZlgt0kvmyy0gPY8UEI+f7zoISOF+m/0.
Are you sure you want to continue connecting (yes/no/[fingerprint])? yes
Warning: Permanently added 'zvmguest,10.11.12.23' (ECDSA) to the list of known hosts.
Welcome to Ubuntu 20.04 LTS (GNU/Linux 5.4.0-39-generic s390x)
```

```
* Documentation: https://help.ubuntu.com
* Management: https://landscape.canonical.com
* Support: https://ubuntu.com/pro
```

System information as of Fri 26 Jun 2020 11:12:23 AM UTC

```
System load: 0.21 Memory usage: 3% Processes: 189
Usage of /: 28.2% of 30.88GB Swap usage: 0% Users logged in: 0
```

```
10 updates can be installed immediately.
0 of these updates are security updates.
To see these additional updates run: apt list --upgradable
```

The programs included with the Ubuntu system are free software; the exact distribution terms for each program are described in the individual files in /usr/share/doc/\*/copyright.

Ubuntu comes with ABSOLUTELY NO WARRANTY, to the extent permitted by applicable law.

To run a command as administrator (user "root"), use "sudo <command>".

See "man sudo\_root" for details.

```
ubuntu@zvmguest:~$ uptime
 11:12:35 up 2 min, 1 user, load average: 0.18, 0.17, 0.08
ubuntu@zvmguest:~$ lsb_release -a
No LSB modules are available.
Distributor ID: Ubuntu
Description: Ubuntu 20.04 LTS
Release: 20.04
Codename: focal
ubuntu@zvmguest:~$ uname -a
Linux zvmguest 5.4.0-39-generic #43-Ubuntu SMP Fri Jun 19 10:27:17
UTC 2020 s390x s390x s390x
GNU/Linux
ubuntu@zvmguest:~$ lszdev | grep yes
dasd-eckd 0.0.1f00 yes yes
qeth 0.0.0600:0.0.0601:0.0.0602 yes yes enc600
ubuntu@zvmguest:~$ exit
logout
Connection to zvmguest closed.
user@workstation:~$
```

## Some closing notes

- It's always best to use the latest installer and autoinstall components: either make sure the installer gets updated to the latest level, or just use a current daily live-server image.
- The ISO image specified with the kernel parameters needs to fit in the boot folder. Its kernel and initrd are specified in the 'Load from Removable Media and Server' task at the hardware management console (HMC).
- In addition to activating disk storage resources in `early-commands`, other devices like OSA/qeth can be added and activated there, too. This is not needed for the basic network device, as specified in the kernel parameters that are used for the installation (that one is automatically handled).
- If everything is properly set up – FTP server for the image, HTTP server for the autoinstall config files – the installation can be as quick as 2 to 3 minutes (depending on the complexity of the autoinstall YAML file).
- There is a simple way of generating a sample autoinstall YAML file: one can perform an interactive Subiquity installation, grab the file `/var/log/installer/autoinstall-user-data`, and use it as an example – but beware that the `early-commands` entries to activate the s390x-specific devices need to be added manually!

This non-interactive installation uses 'autoinstall', which can be considered the successor to the Debian installer (d-i) and preseed on Ubuntu. This is a detailed step-by-step guide, including output and logs (which are partially a bit shortened, as indicated by '...', to limit the size of this document).

The example logical partition (LPAR) here uses zFCP storage and is connected to a VLAN network. For a DASD and a non-VLAN network example, please see the [non-interactive IBM z/VM \(s390x\) autoinstallation guide](#).

- Start with the preparation of the (FTP) install server (if it doesn't already exist).

```
user@local:~$ ssh admin@installserver.local
admin@installserver:~$ mkdir -p /srv/ftp/ubuntu-daily-live-server-20.04
admin@installserver:~$ wget http://cdimage.ubuntu.com/ubuntu-server/focal/daily-live/current/focal-
live-server-s390x.iso --directory-prefix=/srv/ftp/ubuntu-daily-live-server-20.04
--2020-06-26 12:18:48-- http://cdimage.ubuntu.com/ubuntu-server/focal/daily-live/current/focal-live-
server-s390x.iso
Resolving cdimage.ubuntu.com (cdimage.ubuntu.com)... 2001:67c:1560:8001::1d, 2001:67c:1360:8001::28, 2001:67c:1360:
...
Connecting to cdimage.ubuntu.com (cdimage.ubuntu.com)|2001:67c:1560:8001::1d|:80... connected.
HTTP request sent, awaiting response... 200 OK
Length: 700952576 (668M) [application/x-iso9660-image]
Saving to: 'focal-live-server-s390x.iso'

focal-live-server-s 100%[=====] 668.48M 2.73MB/s in 4m 54s

2020-06-26 12:23:42 (2.27 MB/s) - 'focal-live-server-s390x.iso' saved [700952576/700952576]
```

```
admin@installserver:~$
```

- The ISO image needs to be extracted now. Since files in its boot folder need to be modified, loopback mount is not an option here:

```
admin@installserver:~$ cd /srv/ftp/ubuntu-daily-live-server-20.04
admin@installserver:/srv/ftp/ubuntu-daily-live-server-20.04$ mkdir iso
admin@installserver:/srv/ftp/ubuntu-daily-live-server-20.04$ sudo mount -o loop ./focal-live-server-
s390x.iso ./iso
[sudo] password for admin:
mount: /home/user/iso-test/iso: WARNING: device write-protected, mounted read-only.
admin@installserver:/srv/ftp/ubuntu-daily-live-server-20.04$ ls -l
total 684530
-rw-rw-r-- 1 user user 700952576 Jun 26 10:12 focal-live-server-s390x.iso
dr-xr-xr-x 10 root root 2048 Jun 26 10:12 iso
admin@installserver:/srv/ftp/ubuntu-daily-live-server-20.04$ rsync -rtvz ./iso/ . && sync
sending incremental file list
skipping non-regular file "ubuntu"
skipping non-regular file "ubuntu-ports"
./
README.diskdefines
boot.catalog
md5sum.txt
ubuntu.ins
skipping non-regular file "dists/stable"
skipping non-regular file "dists/unstable"
.disk/
.disk/base_installable
.disk/casper-uuid-generic
.disk/cd_type
.disk/info
boot/
boot/README.boot
boot/initrd.off
boot/initrd.siz
boot/initrd.ubuntu
boot/kernel.ubuntu
boot/parmfile.ubuntu
boot/ubuntu.exec
boot/ubuntu.ikr
boot/ubuntu.ins
casper/
...
sent 681,509,758 bytes received 1,857 bytes 22,344,643.11 bytes/sec
total size is 700,317,941 speedup is 1.03
admin@installserver:/srv/ftp/ubuntu-daily-live-server-20.04$ ls -l
total 684578
dr-xr-xr-x 2 user user 4096 Jun 26 10:12 boot
-r--r--r-- 1 user user 2048 Jun 26 10:12 boot.catalog
dr-xr-xr-x 3 user user 4096 Jun 26 10:12 casper
dr-xr-xr-x 3 user user 4096 Jun 26 10:11 dists
-rw-rw-r-- 1 user user 700952576 Jun 26 10:12 focal-live-server-s390x.iso
dr-xr-xr-x 2 user user 4096 Jun 26 10:11 install
dr-xr-xr-x 10 root root 2048 Jun 26 10:12 iso
-r--r--r-- 1 user user 4944 Jun 26 10:12 md5sum.txt
dr-xr-xr-x 2 user user 4096 Jun 26 10:11 pics
dr-xr-xr-x 3 user user 4096 Jun 26 10:11 pool
dr-xr-xr-x 2 user user 4096 Jun 26 10:11 preseed
-r--r--r-- 1 user user 236 Jun 26 10:11 README.diskdefines
-r--r--r-- 1 user user 185 Jun 26 10:12 ubuntu.ins
```

- Now create ins and parm files dedicated to the LPAR that will be installed (here `zlinlpar`), based on the default ins and parm files that are shipped with the ISO image:

```
admin@installserver:/srv/ftp/ubuntu-daily-live-server-20.04$ chmod -R +rw ./boot
```



```

admin@installserver:/srv/ftp/ubuntu-daily-live-server-20.04$ cp ./boot/ubuntu.ins ./boot/ubuntu_zlinlpar.ins
admin@installserver:/srv/ftp/ubuntu-daily-live-server-20.04$ cp ./boot/parmfile.ubuntu ./boot/parmfile.zlinlpar
admin@installserver:/srv/ftp/ubuntu-daily-live-server-20.04$

admin@installserver:/srv/ftp/ubuntu-daily-live-server-20.04$ vi ./boot/ubuntu_zlinlpar.ins
admin@installserver:/srv/ftp/ubuntu-daily-live-server-20.04$ cat ./boot/ubuntu_zlinlpar.ins
* Ubuntu for z Series (default kernel)
kernel.ubuntu 0x00000000
initrd.off 0x0001040c
initrd.siz 0x00010414
parmfile.zlinlpar 0x00010480
initrd.ubuntu 0x01000000
admin@installserver:~$

admin@installserver:/srv/ftp/ubuntu-daily-live-server-20.04$ vi ./boot/parmfile.zlinlpar
admin@installserver:/srv/ftp/ubuntu-daily-live-server-20.04$ cat ./boot/parmfile.zlinlpar

ip=10.11.12.42::10.11.12.1:255.255.255.0:zlinlpar:encc000.4711:none:10.11.12.1 vlan=encc000.4711:encc000 url=http://installserver.local:80/
daily-live-server-20.04/focal-live-server-s390x.iso autoinstall ds=nocloud-net;s=http://installserver.local:80/
-- quiet

```

- Now make sure an FTP server is running in the *installserver* with */srv/ftp* as ftp-server root (as used in this example).
- Now prepare an *autoinstall* (HTTP) server, which hosts the configuration data for the non-interactive installation.

```

admin@installserver:/srv/ftp/ubuntu-daily-live-server-20.04$ mkdir -p /srv/www/autoinstall/zlinlpar
admin@installserver:/srv/ftp/ubuntu-daily-live-server-20.04$ cd /srv/www/autoinstall/zlinlpar
admin@installserver:/srv/www/autoinstall/zlinlpar$
admin@installserver:/srv/www/autoinstall/zlinlpar$ echo "instance-id: $(uuidgen || openssl rand -
base64 8)" > meta-data
admin@installserver:/srv/www/autoinstall/zlinlpar$ cat meta-data
instance-id: 2c2215fb-6a38-417f-b72f-376b1cc44f01
admin@installserver:/srv/www/autoinstall/zlinlpar$

admin@installserver:/srv/www/autoinstall/zlinlpar$ vi user-data
admin@installserver:/srv/www/autoinstall/zlinlpar$ cat user-data
#cloud-config
autoinstall:
 version: 1
 refresh-installer:
 update: yes
 reporting:
 builtin:
 type: print
 apt:
 preserve_sources_list: false
 primary:
 - arches: [amd64, i386]
 uri: http://archive.ubuntu.com/ubuntu
 - arches: [default]
 uri: http://ports.ubuntu.com/ubuntu-ports
 keyboard:
 layout: en
 variant: us
 locale: en_US
 identity:
 hostname: zlinlpar
 password:
"6ebJ1f8wxED22bTL4F46P0"
 username: ubuntu
 user-data:
 timezone: America/Boston
 users:
 - name: ubuntu
 password:

```

```

"6KwuxED22bTL4F46P0"
 lock_passwd: false
 early-commands:
 - touch /tmp/lets_activate_the_s390x_devices
 - chzdev zfcplun -e e000
 - chzdev zfcplun -e e100
 - chzdev zfcplun -e --online
 - touch /tmp/s390x_devices_activation_done
 network:
 ethernet:
 encc000: {}
 version: 2
 vlans:
 encc000.4711:
 addresses: [10.11.12.42/24]
 gateway4: 10.11.12.1
 id: 4711
 link: encc000
 nameservers:
 addresses: [10.11.12.1]
 ssh:
 install-server: true
 allow-pw: true
 authorized-keys: ['ssh-rsa meQwtZ user@workstation # ssh-import-id lp:user']
 admin@installserver:~$

```

- For s390x installations the early-commands section is the interesting part:

```

early-commands:
 - touch /tmp/lets_activate_the_s390x_devices
 - chzdev zfcplun -e e000
 - chzdev zfcplun -e e100
 - chzdev zfcplun -e --online
 - touch /tmp/s390x_devices_activation_done

```

The first and last early-commands are optional; they only frame and indicate the real s390x command activation.

In this particular example, two zFCP hosts (host-bus-adapters) are enabled via their addresses *e000* (`chzdev zfcplun -e e000`) and *e100* (`chzdev zfcplun -e e000`). These have certain logical unit numbers (LUNs) assigned that are all automatically discovered and activated by `chzdev zfcplun -e --online`.

Activation of a direct-access storage device (DASD) would look like this: `chzdev dasd -e 1f00`, and a qeth device activation looks like: `chzdev qeth -e c000`.

#### See also:

For more details about the autoinstall config options, please have a look at the [autoinstall reference](#) and [autoinstall schema](#) pages.

- Now make sure a HTTP server is running with `/srv/www` as web-server root (in this particular example).
- Next steps need to be done at the hardware management console (HMC). First, connect to the HMC and proceed with the 'Load From Removable Media and Server' task.
- Then, start the 'Load from Removable Media or Server' task under 'Recovery' --> 'Load from Removable Media or Server' on your specific LPAR that you are going to install, and fill out the following fields (the contents will be of course different on your system):

```

FTP Source
Host computer: installserver.local
User ID: ftpuser
Password: *****
Account (optional):
File location (optional): ubuntu-daily-live-server-20.04/boot

```

- Now confirm the entered data and click 'OK'.
- At the 'Load from Removable Media or Server - Select Software to Install' screen, choose the LPAR that is going to be installed, here:

ubuntu-daily-live-server-20.04/boot/ubuntu\_zlinlpar.ins Ubuntu for z Series (default kernel)

- Confirm again with 'OK'.
- And another confirmation about the 'Load will cause jobs to be cancelled'.
- Then, another 'Yes' – understanding that it's a disruptive task:

Disruptive Task Confirmation : Load from Removable Media or Server

- Now monitor the 'Load from Removable media or Server Progress' screen and confirm it once again when the status changes from 'Please wait while the image is being loaded.' to 'Success'.
- Then navigate to 'Daily' --> 'Operating System Messages' to monitor the initial program load (IPL) of the install system ...

Message

```
chzdev: Unknown device type or device ID format: c000.4711
Use 'chzdev --help' for more information
QETH device 0.0.c000:0.0.c001:0.0.c002 configured
IP-Config: encc000.4711 hardware address 1a:3c:99:55:2a:ef mtu 1500
IP-Config: encc000.4711 guessed broadcast address 10.11.12.255
IP-Config: encc000.4711 complete:
address: 10.11.12.42 broadcast: 10.11.12.255 netmask: 255.255.255.0
```

```
gateway: 10.11.12.1 dns0 : 10.11.12.1 dns1 : 0.0.0.0
```

host : zlinlpar

rootserver: 0.0.0.0 rootpath:

filename :

Connecting to installserver.local:80 (installserver.local:80)

```
focal-live-server-s3 5% |* | 39.9M 0:00:15 ETA
focal-live-server-s3 22% |***** | 147M 0:00:07 ETA
focal-live-server-s3 38% |***** | 254M 0:00:04 ETA
focal-live-server-s3 53% |***** | 355M 0:00:03 ETA
focal-live-server-s3 67% |***** | 453M 0:00:02 ETA
focal-live-server-s3 81% |***** | 545M 0:00:01 ETA
focal-live-server-s3 94% |***** | 633M 0:00:00 ETA
focal-live-server-s3 100%|***** | 668M 0:00:00 ETA
```

mount: mounting /cow on /root/cow failed: No such file or directory

Connecting to plymouth: Connection refused

passwd: password expiry information changed.

Using CD-ROM mount point /cdrom/

Identifying... [5d25356068b713167814807dd678c261-2]

Scanning disc for index files...

Found 2 package indexes, 0 source indexes, 0 translation indexes and 1 signature

Found label 'Ubuntu-Server 20.04 LTS \_Focal Fossa\_ - Release s390x (20200616)'

This disc is called:

'Ubuntu-Server 20.04 LTS \_Focal Fossa\_ - Release s390x (20200616)'

...

[ 61.190916] cloud-init[2076]: Cloud-init v. 20.1-10-g71af48df-0ubuntu5 running 'modules:final' at Fri, 26 Jun 2020 11:02:01 +0000. Up 61.09 seconds.

[ 61.191002] cloud-init[2076]: ci-info: no authorized SSH keys fingerprints found for user installer.

[ 61.191071] cloud-init[2076]: Cloud-init v. 20.1-10-g71af48df-0ubuntu5 finished at Fri, 26 Jun 2020 11:02:01 +0000

Datasource DataSourceNoCloudNet [seed=cmdline,

/var/lib/cloud/seed/nocloud,

http://installserver.local:80/autoinstall/zlinlpar/]

[dsmode=net]. Up 61.18 seconds

[ 61.191136] cloud-init[2076]: Welcome to Ubuntu Server Installer!

[ 61.191202] cloud-init[2076]: Above you will find SSH host keys and a random

password set for the `installer` user. You can use these credentials to ssh-in

and complete the installation. If you provided SSH keys in the cloud-init datasource, they were also provisioned to the installer user.

[ 61.191273] cloud-init[2076]: If you have access to the graphical console, like TTY1 or HMC ASCII terminal you can complete the installation there too.

It is possible to connect to the installer over the network, which might allow the use of a more capable terminal.

To connect, SSH to installer@10.11.12.42.

The password you should use is 'i7UFdP8fhiVVMme3qqH8'.

The host key fingerprints are:

```
RSA SHA256:rBXLeUke3D4gKdsruKEajHjocxc9hr3PI
ECDSA SHA256:KZZYFswtKxFXWQPuQS9Qp0BUoS6RHswis
ED25519 SHA256:s+5tZfagx0zffC6gYRGW3t1KcBH6f+Vt0
```

Ubuntu 20.04 LTS ubuntu-server sclp\_line0

- At short notice, you can even log in to the system with the user 'installer' and the temporary password that was given at the end of the boot-up process (see above) of the installation system:

```
user@workstation:~$ ssh installer@zlinlpar
The authenticity of host 'zlinlpar (10.11.12.42)' can't be established.
ECDSA key fingerprint is SHA256:0/du/D8jJAEGQcbqKGE9La24IRxUPLpzzs5li9F6Vvk.
Are you sure you want to continue connecting (yes/no/[fingerprint])? yes
Warning: Permanently added 'zlinlpar,10.11.12.42' (ECDSA) to the list of known hosts.
installer@zlinlpar's password:
Welcome to Ubuntu 20.04 LTS (GNU/Linux 5.4.0-37-generic s390x)
```

```
* Documentation: https://help.ubuntu.com
* Management: https://landscape.canonical.com
* Support: https://ubuntu.com/pro
```

System information as of Fri Jun 26 11:08:18 UTC 2020

```
System load: 1.25 Memory usage: 4% Processes: 192
Usage of /home: unknown Swap usage: 0% Users logged in: 0
```

```
0 updates can be installed immediately.
0 of these updates are security updates.
```

The list of available updates is more than a week old.  
To check for new updates run: `sudo apt update`

The programs included with the Ubuntu system are free software;  
the exact distribution terms for each program are described in the  
individual files in `/usr/share/doc/*/copyright`.

Ubuntu comes with ABSOLUTELY NO WARRANTY, to the extent permitted by  
applicable law.

the installer running on `/dev/tty1` will perform the autoinstall

press enter to start a shell

- Notice that it informs you about a currently-running autoinstall process:  
the installer running on `/dev/tty1` will perform the autoinstall
- Nevertheless, we can quickly check some things – though only until the autoinstall process has finished and the post-install reboot has been triggered:

```
root@ubuntu-server:/# ls -l /tmp/lets_activate_the_s390x_devices
-rw-r--r-- 1 root root 0 Jun 26 11:08 /tmp/lets_activate_the_s390x_devices
-rw-r--r-- 1 root root 0 Jun 26 11:09 /tmp/s390x_devices_activation_done
```

```

root@ubuntu-server:/# lsudev | grep yes
zfcplib 0.0.e000 yes yes
zfcplib 0.0.e100 yes yes
zfcplib 0.0.e000:0x50050763060b16b6:0x4026400200000000 yes yes sdb sg1
zfcplib 0.0.e000:0x50050763061b16b6:0x4026400200000000 yes yes sda sg0
zfcplib 0.0.e100:0x50050763060b16b6:0x4026400200000000 yes yes sdd sg3
zfcplib 0.0.e100:0x50050763061b16b6:0x4026400200000000 yes yes sdc sg2
qeth 0.0.c000:0.0.c001:0.0.c002 yes no encc000
root@ubuntu-server:/#

```

- If you wait long enough you'll see the remote session get closed:

```

root@ubuntu-server:/# Connection to zlinlpar closed by remote host.
Connection to zlinlpar closed.
user@workstation:~$

```

- As well as at the console:

```

ubuntu-server login:

[[0;1;31mFAILED[0m] Failed unmounting [0;1;39m/cdrom[0m.
[169.161139] sd-umoun[15600]: Failed to unmount /oldroot: Device or resource busy
[169.161550] sd-umoun[15601]: Failed to unmount /oldroot/cdrom: Device or resource busy
[169.168118] shutdown[1]: Failed to finalize file systems, loop devices, ignoring
Total: 282 Selected: 0

```

Command:

- ...and that the post-install reboot gets triggered:

```

Message
Mounting [0;1;39mKernel Configuration File System[0m...
Starting [0;1;39mApply Kernel Variables[0m...
[[0;32m OK [0m] Finished [0;1;39mRemount Root and Kernel File Systems[0m.
[[0;32m OK [0m] Finished [0;1;39mUncomplicated firewall[0m.
[[0;32m OK [0m] Mounted [0;1;39mFUSE Control File System[0m.
[[0;32m OK [0m] Mounted [0;1;39mKernel Configuration File System[0m.
...
[35.378928] cloud-init[2565]: Cloud-init v. 20.1-10-g71af48df-0ubuntu5 runnin
g 'modules:final' at Fri, 26 Jun 2020 11:10:44 +0000. Up 35.29 seconds.
[35.378978] cloud-init[2565]: Cloud-init v. 20.1-10-g71af48df-0ubuntu5 finish
ed at Fri, 26 Jun 2020 11:10:44 +0000. Datasource DataSourceNone. Up 35.37 seconds
[35.379008] cloud-init[2565]: 2020-06-26 11:10:44,359 - cc_final_message.py[W
ARNING]: Used fallback datasource
[[0;32m OK [0m] Finished [0;1;39mExecute cloud user/final scripts[0m.
[[0;32m OK [0m] Reached target [0;1;39mCloud-init target[0m.

```

zlinlpar login:

- With the completion of the reboot, the autoinstall is finished and the LPAR is ready to use:

```

user@workstation:~$ ssh-keygen -f "/home/user/.ssh/known_hosts" -R "zlinlpar"
Host zlinlpar found: line 163
/home/user/.ssh/known_hosts updated.
Original contents retained as /home/user/.ssh/known_hosts.old
user@workstation:~$ ssh ubuntu@zlinlpar
The authenticity of host 'zlinlpar (10.11.12.42)' can't be established.
ECDSA key fingerprint is SHA256:iGtCARAg+ZnoZlgt0kvmyy0gPY8UEI+f7zoISOF+m/0.
Are you sure you want to continue connecting (yes/no/[fingerprint])? yes
Warning: Permanently added 'zlinlpar,10.11.12.42' (ECDSA) to the list of known hosts.
Welcome to Ubuntu 20.04 LTS (GNU/Linux 5.4.0-39-generic s390x)

```

```

* Documentation: https://help.ubuntu.com
* Management: https://landscape.canonical.com
* Support: https://ubuntu.com/pro

```

System information as of Fri 26 Jun 2020 11:12:23 AM UTC

```
System load: 0.21 Memory usage: 3% Processes: 189
Usage of /: 28.2% of 30.88GB Swap usage: 0% Users logged in: 0
```

10 updates can be installed immediately.  
0 of these updates are security updates.  
To see these additional updates run: `apt list --upgradable`

The programs included with the Ubuntu system are free software;  
the exact distribution terms for each program are described in the  
individual files in `/usr/share/doc/*/copyright`.

Ubuntu comes with ABSOLUTELY NO WARRANTY,  
to the extent permitted by applicable law.

To run a command as administrator (user "root"), use "sudo <command>".  
See "man sudo\_root" for details.

```
ubuntu@zlinlpar:~$ uptime
 11:12:35 up 2 min, 1 user, load average: 0.18, 0.17, 0.08
ubuntu@zlinlpar:~$ lsb_release -a
No LSB modules are available.
Distributor ID: Ubuntu
Description: Ubuntu 20.04 LTS
Release: 20.04
Codename: focal
ubuntu@zlinlpar:~$ uname -a
Linux zlinlpar 5.4.0-39-generic #43-Ubuntu SMP Fri Jun 19 10:27:17
UTC 2020 s390x s390x s390x
GNU/Linux
ubuntu@zlinlpar:~$ lszdev | grep yes
zfcplib 0.0.e000 yes yes
zfcplib 0.0.e100 yes yes
zfcplib 0.0.e000:0x50050763060b16b6:0x4026400200000000 yes yes
sdb sg1
zfcplib 0.0.e000:0x50050763061b16b6:0x4026400200000000 yes yes
sda sg0
zfcplib 0.0.e100:0x50050763060b16b6:0x4026400200000000 yes yes
sdc sg2
zfcplib 0.0.e100:0x50050763061b16b6:0x4026400200000000 yes yes
sdd sg3
qeth 0.0.c000:0.0.c001:0.0.c002 yes yes encc000
ubuntu@zlinlpar:~$ exit
logout
Connection to zlinlpar closed.
user@workstation:~$
```

## Some closing notes

- It's always best to use the latest installer and autoinstall components. Be sure to update the installer to the most recent version, or just use a current daily live-server image.
- The ISO image specified with the kernel parameters needs to fit in the boot folder. Its kernel and initrd are specified in the 'Load from Removable Media and Server' task at the hardware management console (HMC).
- In addition to activating disk storage resources in `early-commands`, other devices like OSA/qeth can be added and activated there, too. This is not needed for the basic network device, as specified in the kernel parameters used for the installation (that one is automatically handled).
- If everything is properly set up – FTP server for the image, HTTP server for the autoinstall config files – the installation can be as quick as 2 to 3 minutes. Of course this depends on the complexity of the autoinstall YAML file.
- There is a simple way of generating a sample autoinstall YAML file; one can perform an interactive Subiquity installation, grab the file `/var/log/installer/autoinstall-user-data`, and use it as an example – but beware

that the `early-commands` entries to activate the s390x-specific devices need to be added manually!

## What are ROCKs?

Ordinary software packages can often be installed in a variety of different types of environments that satisfy the given packaging system. However, these environments can be quite varied, such as including versions of language runtimes, system libraries, and other library dependencies that the software was not well tested with.

Software containers address this by encapsulating both the software and the surrounding environment. Instead of installing and maintaining a collection of software packages, the user runs and maintains a single container, instantiated from a container image with the desired software already installed. The user relies on the provider of the container image to perform the necessary software testing and maintenance updates. There is a rich ecosystem of container providers thanks mainstream tools like Docker, and popular container registries like Docker Hub, Amazon ECR, etc., which make it easy for anyone to build and publish a container image. Unfortunately, with that freedom and flexibility invariably comes unreliability of maintenance and inconsistency of implementation.

The *Open Container Initiative* (OCI) establishes standards for constructing container images that can be reliably installed across a variety of compliant host environments.

Ubuntu's [LTS Docker Image Portfolio](#) provides OCI-compliant images that receive stable security updates and predictable software updates, thus ensuring consistency in both maintenance schedule and operational interfaces for the underlying software your software builds on.

## Container Creation and Deletion

Over the course of this tutorial we'll explore deriving a customized Apache container, and then networking in a Postgres container backend for it. By the end you'll have a working knowledge of how to set up a container-based environment using Canonical's ROCKs.

First the absolute basics. Let's spin up a single container providing the Apache2 web server software:

```
$ sudo apt-get update
$ sudo apt-get -y install docker.io
$ sudo docker run -d --name my-apache2-container -p 8080:80 ubuntu/apache2:2.4-22.04_beta
Unable to find image 'ubuntu/apache2:2.4-22.04_beta' locally
2.4-22.04_beta: Pulling from ubuntu/apache2
13c61b50dd15: Pull complete
34dadde438e6: Pull complete
d8e11cec95e6: Pull complete
Digest: sha256:11647ce68a130540150dfebbb755ee79c908103fafbf805074eb6513e6b9df83
Status: Downloaded newer image for ubuntu/apache2:2.4-22.04_beta
4031e6ed24a6e08185efd1c60e7df50f8f60c21ed9961c858ca0cb6bb300a72a
```

This container, named `my-apache2-container` runs in an Ubuntu 22.04 LTS environment and can be accessed via local port 8080. Load the website up in your local web browser:

```
$ firefox http://localhost:8080
```

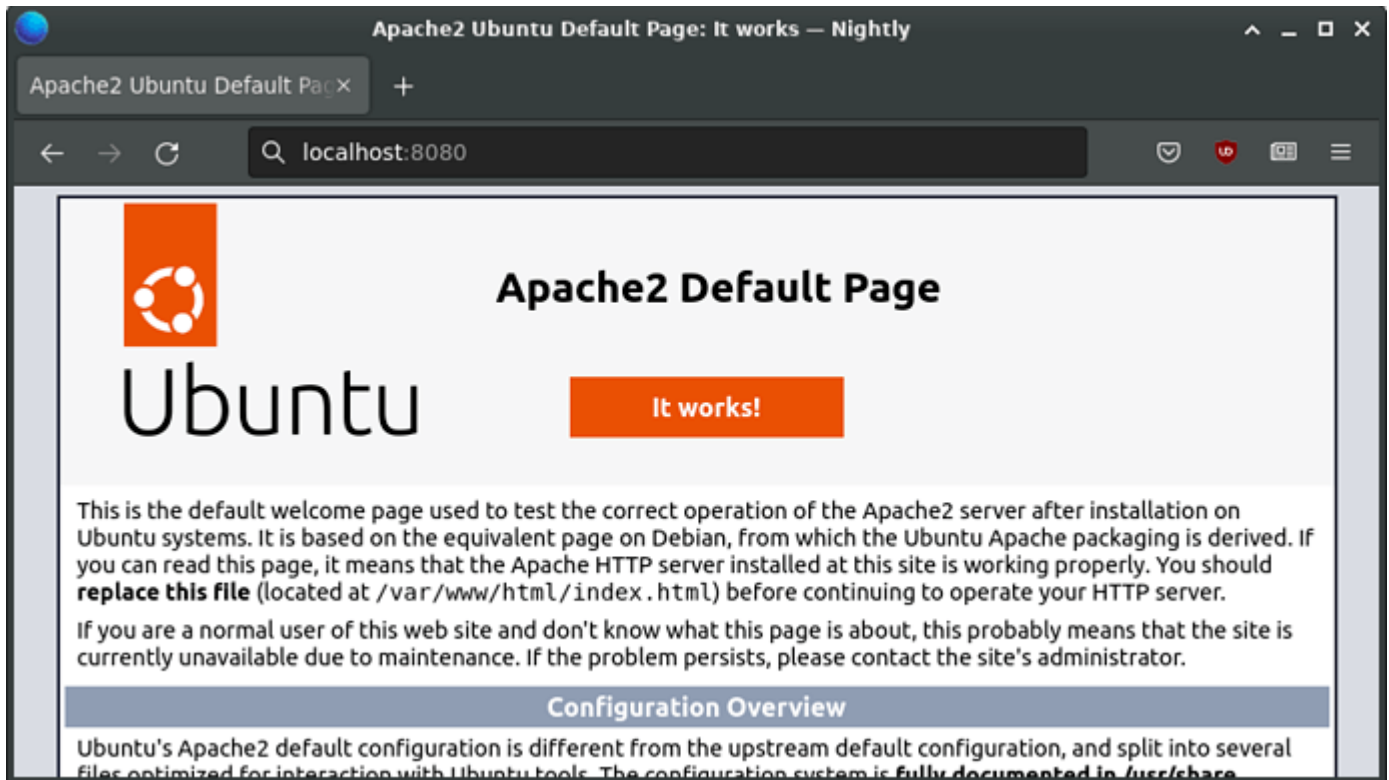

apache2-container867×490 64.8 KB

If you don't have firefox handy, curl can be used instead:

```
$ curl -s http://localhost:8080 | grep "<title>"
<title>Apache2 Ubuntu Default Page: It works</title>
```

The run command had a number of parameters to it. The Usage section of [Ubuntu's Docker hub page for Apache2](#) has a table with an overview of parameters specific to the image, and [Docker itself](#) has a formal reference of all available parameters, but lets go over what we're doing in this particular case:

```
$ sudo docker run -d --name my-apache2-container -e TZ=UTC -p 8080:80 ubuntu/apache2:2.4-22.04_beta
```

The `-d` parameter causes the container to be detached so it runs in the background. If you omit this, then you'll want to use a different terminal window for interacting with the container. The `--name` parameter allows you to use a defined name; if it's omitted you can still reference the container by its Docker id. The `-e` option lets you set environment variables used when creating the container; in this case we're just setting the timezone (TZ) to universal time (UTC). The `-p` parameter allows us to map port 80 of the container to 8080 on localhost, so we can reference the service as `http://localhost:8080`. The last parameter indicates what software image we want.

A variety of other container images are provided on [Ubuntu's Docker Hub](#) and on [Amazon ECR](#), including documentation of supported customization parameters and debugging tips. This lists the different major/minor versions of each piece of software, packaged on top of different Ubuntu LTS releases. So for example, in specifying our requested image as `ubuntu/apache2:2.4-22.04_beta` we used Apache2 version 2.4 running on a Ubuntu 22.04 environment.

Notice that the image version we requested has `_beta` appended to it. This is called a *Channel Tag*. Like most software, Apache2 provides incremental releases numbered like 2.4.51, 2.4.52, and 2.4.53. Some of these releases are strictly bugfix-only, or even just CVE security fixes; others may include new features or other improvements. If we think of the series of these incremental releases for Apache2 2.4 on Ubuntu 22.04 as running in a *Channel*, the *Channel Tags* point to the newest incremental release that's been confirmed to the given level of stability. So, if a new incremental release 2.4.54 becomes available, `ubuntu/apache2:2.4-22.04_edge` images would be updated to that version rapidly, then `ubuntu/apache2:2.4-22.04_beta` once it's received some basic testing; eventually, if no problems are found, it will also be available in `ubuntu/apache2:2.4-22.04_candidate` and then in `ubuntu/apache2:2.4-22.04_stable` once it's validated as completely safe.

For convenience there's also a `latest` tag and an `edge` tag which are handy for experimentation or where you don't care what version is used and just want the newest available. For example, to launch the latest version of Nginx, we can do so as before, but specifying `latest` instead of the version:

```
$ sudo docker run -d --name my-nginx-container -e TZ=UTC -p 9080:80 ubuntu/nginx:latest
4dac8d77645d7ed695bdcb3409a8eda942393067dad49e4ef3b8b1bdc5d584
```



```
$ curl -s http://localhost:9080 | grep "<title>"
<title>Welcome to nginx!</title>
```

We've also changed the port to 9080 instead of 8080 using the `-p` parameter, since port 8080 is still being used by our `apache2` container. If we were to try to also launch Nginx (or another Apache2 container) on port 8080, we'd get an error message, `Bind for 0.0.0.0:8080 failed: port is already allocated` and then would need to remove the container and try again.

Speaking of removing containers, now that we know how to create generic default containers, let's clean up:

```
$ sudo docker ps
CONTAINER ID IMAGE COMMAND CREATED STATUS PORTS NAMES
d86e93c98e20 ubuntu/apache2:2.4-22.04_beta "apache2-foreground" 29 minutes ago Up 29 minutes 0.0.0.0:8080->80/tcp, :::8080->80/tcp my-apache2-container
eed23be5f65d ubuntu/nginx:latest "/docker-entrypoint.…" 18 minutes ago Up 18 minutes 0.0.0.0:9080->80/tcp, :::9080->80/tcp my-nginx-container

$ sudo docker stop my-apache2-container
$ sudo docker rm my-apache2-container

$ sudo docker stop my-nginx-container
$ sudo docker rm my-nginx-container
```

To be able to actually use the containers, we'll have to configure and customize them, which we'll look at [next](#).

In the [last section](#) we looked at the basics of how to start and stop containers. Here we'll apply our own modifications to the images.

You'll recall we used the `-p` parameter to give the two containers we created different ports so they didn't conflict with each other. We can think of this type of customization as a *container configuration*, as opposed to an *image configuration* change defined in the `Dockerfile` settings for the image itself. From a single image definition we can create an arbitrary number of different containers with different ports (or other pre-defined aspects), which are all otherwise reliably identical. A third approach is to modify the running container after it has been launched, applying whatever arbitrary changes we wish as *runtime modifications*.

- **image configuration:** Done in `Dockerfile`, changes common to all container instances of that image. Requires rebuilding the image.
- **container configuration:** Done at container launch, allowing variation between instances of a given image. Requires re-launching the container to change.
- **runtime modifications:** Done dynamically after container launch. Does not require re-launching the container.

The second approach follows Docker's immutable infrastructure principle, and is what the ROCKs system intends for production environments. For the sake of this tutorial we'll use the third approach for introductory purposes, building on that later to show how to achieve the same with only configuration at container creation time.

## Setting up a Development Environment

Speaking of doing things properly, let's prepare a virtual machine (VM) to do our tutorial work in.

While you can of course install the `docker.io` package directly on your desktop, as you may have done in the previous section of this tutorial, using it inside a VM has a few advantages. First, it encapsulates the system changes you want to experiment with, so that they don't affect your desktop; if anything gets seriously messed up you just can delete the VM and start over. Second, it facilitates experimenting with different versions of Ubuntu, Docker, or other tools than would be available from your desktop. Third, since "The Cloud" is built with VM's, developing in a VM from the start lets you more closely emulate likely types of environments you'll be deploying to.

There are a number of different VM technologies available, any of which will suit our purposes, but for this tutorial we'll set one up using Canonical's Multipass software, which you can install [on Windows using a downloadable installer](#), or [on macOS via brew](#), or [any flavor of Linux via snapd](#).

Here's how to launch a Ubuntu 22.04 VM with a bit of extra resources, and log in:

```
host> multipass launch --cpus 2 --mem 4G --disk 10G --name my-vm daily:20.04
host> multipass shell my-vm
```

If later you wish to suspend or restart the VM, use the stop/start commands:

```
host> multipass stop my-vm
host> multipass start my-vm
```

Go ahead and set up your new VM devel environment with Docker, your preferred editor, and any other tools you like having on hand:

```
$ sudo apt-get update
$ sudo apt-get -y install docker.io
```

## Data Customization

The most basic customization for a webserver would be the index page. Let's replace the default one with the typical hello world example:

```
$ echo '<html><title>Hello Docker...</title><body>Hello Docker!</body></html>' > index.html
```

The technique we'll use to load this into the webserver container is called *bind mounting a volume*, and this is done with the `-v` (or `--volume`) flag to `docker run` (not to be confused with `docker -v` which of course just prints the docker version). A *volume* is a file or directory tree or other data on the host we wish to provide via the container. A *bind mount* means rather than copying the data *into* the container, we establish a linkage between the local file and the file in the container. Have a look at how this works:

```
$ sudo docker run -d --name my-apache2-container -e TZ=UTC -p 8080:80 -v "${HOME}/index.html:/var/www/html/index.html" ubuntu
...
```

```
$ curl http://localhost:8080
<html><title>Hello Docker...</title></html>
```

```
$ sudo docker inspect -f "{{ .Mounts }}" my-apache2-container
[{"bind /home/ubuntu/index.html /var/www/html/index.html true rprivate}]
```

Watch what happens when we change the `index.html` contents:

```
$ echo '<html><title>...good day!</title></html>' > index.html
```

```
$ curl http://localhost:8080
<html><title>...good day</title></html>
```

This linkage is two-way, which means that the container itself can change the data. (We mentioned *runtime modifications* earlier – this would be an example of doing that.)

```
$ sudo docker exec -ti my-apache2-container /bin/bash
```

```
root@abcd12345678:/# echo '<html><title>Hello, again</title></html>' > /var/www/html/index.html
root@abcd12345678:/# exit
exit
```

```
$ curl http://localhost:8080
<html><title>Hello, again</title></html>
```

What if we don't want that behavior, and don't want to grant the container the ability to do so? We can set the bind mount to be read-only by appending `:ro`:

```
$ sudo docker stop my-apache2-container
$ sudo docker rm my-apache2-container
$ sudo docker run -d --name my-apache2-container -e TZ=UTC -p 8080:80 -v "${HOME}/index.html:/var/www/html/index.html:ro" ubuntu
```

```
$ sudo docker exec -ti my-apache2-container /bin/bash
```

```
root@abcd12345678:/# echo '<html><title>good day, sir!</title></html>' > /var/www/html/index.html
bash: /var/www/html/index.html: Read-only file system
```

```
root@abcd12345678:/# exit
```

```
$ curl http://localhost:8080
<html><title>Hello, again</title></html>
```

However, the read-only mount still sees changes on the host side:

```
$ echo '<html><title>I said good day!</title></html>' > ./index.html
```

```
$ curl http://localhost:8080
```



## Network

IP addresses may be suitable for debugging purposes, but as we move beyond individual containers we'll want to refer to them by network hostnames. First we create the network itself:

```
$ sudo docker network create my-network
c1507bc90cfb6100fe0e696986eb99afe64985c7c4ea44ad319f8080e640616b
```

```
$ sudo docker network list
NETWORK ID NAME DRIVER SCOPE
7e9ce8e7c0fd bridge bridge local
6566772ff02f host host local
c1507bc90cfb my-network bridge local
8b992742eb38 none null local
```

Now when creating containers we can attach them to this network:

```
$ sudo docker run -d --name my-container-0 --network my-network ubuntu/apache2:latest
$ sudo docker run -d --name my-container-1 --network my-network ubuntu/apache2:latest
```

```
$ sudo docker exec -it my-container-0 /bin/bash
root@abcd12345678:/# apt-get update && apt-get install -y iputils-ping bind9-dnsutils
root@abcd12345678:/# ping my-container-1 -c 1| grep statistics -A1
--- my-container-1 ping statistics ---
1 packets transmitted, 1 received, 0% packet loss, time 0ms
```

```
root@abcd12345678:/# dig +short my-container-0 my-container-1
172.18.0.2
172.18.0.3
```

```
root@abcd12345678:/# exit
```

```
$ sudo docker stop my-container-0 my-container-1
$ sudo docker rm my-container-0 my-container-1
```

A common use case for networked containers is load balancing. Docker's `--network-alias` option provides one means of setting up *round-robin* load balancing at the network level during container creation:

```
$ sudo docker run -d --name my-container-0 --network my-network --network-alias my-website -e TZ=UTC -
p 8080:80 -v ${HOME}/index.html:/var/www/html/index.html:ro ubuntu/apache2:latest
$ sudo docker run -d --name my-container-1 --network my-network --network-alias my-website -e TZ=UTC -
p 8081:80 -v ${HOME}/index.html:/var/www/html/index.html:ro ubuntu/apache2:latest
$ sudo docker run -d --name my-container-2 --network my-network --network-alias my-website -e TZ=UTC -
p 8082:80 -v ${HOME}/index.html:/var/www/html/index.html:ro ubuntu/apache2:latest
```

```
$ sudo docker ps
CONTAINER ID IMAGE COMMAND CREATED STATUS PORTS NAMES
665cf336ba9c ubuntu/apache2:latest "apache2-foreground" 4 days ago Up 4 days 0.0.0.0:8082->80/tcp, :::8082->80/tcp my-container-2
fd952342b6f8 ubuntu/apache2:latest "apache2-foreground" 4 days ago Up 4 days 0.0.0.0:8081->80/tcp, :::8081->80/tcp my-container-1
0592e413e81d ubuntu/apache2:latest "apache2-foreground" 4 days ago Up 4 days 0.0.0.0:8080->80/tcp, :::8080->80/tcp my-container-0
```

The `my-website` alias selects a different container for each request it handles, allowing load to be distributed across all of them.

```
$ sudo docker exec -it my-container-0 /bin/bash
root@abcd12345678:/# apt update; apt install -y bind9-dnsutils
root@abcd12345678:/# dig +short my-website
172.18.0.3
172.18.0.2
172.18.0.4
```

Run that command several times, and the output should display in a different order each time.

```
root@abcd12345678:/# dig +short my-website
172.18.0.3
```

```

172.18.0.4
172.18.0.2
root@abcd12345678:/# dig +short my-website
172.18.0.2
172.18.0.3
172.18.0.4
root@abcd12345678:/# exit

```

```

$ sudo docker stop my-container-0 my-container-1 my-container-2
$ sudo docker rm my-container-0 my-container-1 my-container-2

```

## Installing Software

By default Apache2 can serve static pages, but for more than that it's necessary to enable one or more of its modules. As we mentioned above, there are three approaches you could take: Set things up at runtime by logging into the container and running commands directly; configuring the container at creation time; or, customizing the image definition itself.

Ideally, we'd use the second approach to pass a parameter or setup.sh script to install software and run `a2enmod <mod>`, however the Apache2 image lacks the equivalent of Postgres' `/docker-entrypoint-initdb.d/` directory and automatic processing of shell scripts. So for a production system you'd need to derive your own customized Apache2 image and build containers from that.

For the purposes of this tutorial, though, we can use the runtime configuration approach just for experimental purposes.

First, create our own config file that enables CGI support:

```

$ cat > ~/my-apache2.conf << 'EOF'
User ${APACHE_RUN_USER}
Group ${APACHE_RUN_GROUP}
ErrorLog ${APACHE_LOG_DIR}/error.log
ServerName localhost
HostnameLookups Off
LogLevel warn
Listen 80

Include module configuration:
IncludeOptional mods-enabled/*.load
IncludeOptional mods-enabled/*.conf

<Directory />
 AllowOverride None
 Require all denied
</Directory>

<Directory /var/www/html/>
 AllowOverride None
 Require all granted
</Directory>

<Directory /var/www/cgi-bin/>
 AddHandler cgi-script .cgi
 AllowOverride None
 Options +ExecCGI -MultiViews
 Require all granted
</Directory>

<VirtualHost *:80>
 DocumentRoot /var/www/html/
 ScriptAlias /cgi-bin/ /var/www/cgi-bin/
</VirtualHost>
EOF

```

Next, copy the following into a file named `fortune.cgi`.

```

$ cat > ~/fortune.cgi << 'EOF'

```

```
#!/usr/bin/env bash
echo -n -e "Content-Type: text/plain\n\n"
echo "Hello ${REMOTE_ADDR}, I am $(hostname -f) at ${SERVER_ADDR}"
echo "Today is $(date)"
if [-x /usr/games/fortune]; then
 /usr/games/fortune
fi
EOF
$ chmod a+x ~/fortune.cgi
```

Now create our container:

```
$ sudo docker run -d --name my-fortune-cgi -e TZ=UTC -p 9080:80 \
-v $(pwd)/my-apache2.conf:/etc/apache2/apache2.conf:ro \
-v $(pwd)/fortune.cgi:/var/www/cgi-bin/fortune.cgi:ro \
ubuntu/apache2:latest
c3709dc03f24fbf862a8d9499a03015ef7ccb5e76fdea0dc4ac62a4c853597bf
```

Next, perform the runtime configuration steps:

```
$ sudo docker exec -it my-fortune-cgi /bin/bash
```

```
root@abcd12345678:/# apt-get update && apt-get install -y fortune
root@abcd12345678:/# a2enmod cgi
root@abcd12345678:/# service apache2 force-reload
```

Finally, restart the container so our changes take effect:

```
$ sudo docker restart my-fortune-cgi
my-fortune-cgi
```

Let's test it out:

```
$ curl http://localhost:9080/cgi-bin/fortune.cgi
Hello 172.17.0.1, I am 8ace48b71de7 at 172.17.0.2
Today is Wed Jun 1 16:59:40 UTC 2022
Q: Why is Christmas just like a day at the office?
A: You do all of the work and the fat guy in the suit
 gets all the credit.
```

Finally is cleanup, if desired:

```
$ sudo docker stop my-fortune-cgi
$ sudo docker rm my-fortune-cgi
```

## Next

While it's interesting to be able to customize a basic container, how can we do this without resorting to runtime configuration? As well, a single container by itself is not terribly useful, so in the [next section](#) we'll practice setting up a database node to serve data to our webserver.

The [prior section](#) explained the use of a single container for running a single software instance, but the principle benefit of using ROCKs is the ability to easily create and architecturally organize, or "orchestrate", them to operate together in a modular fashion.

If you set up a VM while following that section, you can continue to use that here, or if not feel free to create a new VM for this section, using those same directions.

## Colors Web App

This section will demonstrate use of `docker-compose` to set up two nodes that inter-operate to implement a trivial CGI web app that lets the user select a background color from the standard `rgb.txt` color codes. Here's the table definition itself:

```
$ cat > ~/my-color-database.sql <<'EOF'
CREATE DATABASE my_color_db;

CREATE TABLE "color"
(
 id INTEGER GENERATED BY DEFAULT AS IDENTITY PRIMARY KEY,
```

```

 red INTEGER,
 green INTEGER,
 blue INTEGER,
 colorname VARCHAR NOT NULL
);

REVOKE ALL ON "color" FROM public;
GRANT SELECT ON "color" TO "postgres";

```

EOF

For the data, we'll scarf up X11's `rgb.txt` file, which should be readily at hand with most Ubuntu desktop installations:

```

$ sudo apt-get install x11-common
$ grep -v ^! /usr/share/X11/rgb.txt | \
awk 'BEGIN{print "INSERT INTO color(red, green, blue, colorname) VALUES"}
 $1 != $2 || $2 != $3 {
 printf(" (%d, %d, %d, '\''", $1, $2, $3);
 for (i = 4; i <= NF; i++) {
 printf("%s", $i);
 }
 printf("\'\'),\n");
 }
END {print " (0, 0, 0, '\''black'\''");}' >> ~/my-color-database.sql

```

Here's the corresponding CGI script:

```

$ cat > ~/my-colors.cgi <<'EOF'
#!/usr/bin/env python3

import cgi
import pycpg2

Get web form data (if any)
query_form = cgi.FieldStorage()
if 'bgcolor' in query_form.keys():
 bgcolor = query_form["bgcolor"].value
else:
 bgcolor = 'FFFFFF'

print("Content-Type: text/html\n\n");

Head
body_style = "body { background-color: #%s; }" %(bgcolor)
text_style = ".color-invert { filter: invert(1); mix-blend-mode: difference; }"
print(f"<html>\n<head><style>\n{body_style}\n{text_style}\n</style></head>\n")
print("<body>\n<h1 class='color-invert'>Pick a background color:</h1>\n")
print("<table width='500' cellpadding='0' cellspacing='0'>\n")
print(" <tr><th width='50'>Color</th><th>Name</th><th width='100'>Code</th></tr>\n")

Connect database
db = pycpg2.connect(host='examples_postgres_1', user='postgres', password='myS&cret')

Display the colors
colors = db.cursor()
colors.execute("SELECT * FROM color;")
for row in colors.fetchall():
 code = ''.join('{:02X}'.format(a) for a in row[1:4])
 color = row[4]
 print(f" <tr style='background-color:#{code}'>\n")
 print(f" <td>{color}</td>\n")
 print(f" </tr>\n")

Foot
print("</table>\n")

```

```
print("</body>\n</html>\n")
EOF
```

By default, Apache2 is configured to allow CGI scripts in the `/usr/lib/cgi-bin` system directory, but rather than installing the script there, let's use our own directory to serve from:

```
$ cat > ~/my-apache.conf <<'EOF'
User ${APACHE_RUN_USER}
Group ${APACHE_RUN_GROUP}
ErrorLog ${APACHE_LOG_DIR}/error.log
ServerName localhost
HostnameLookups Off
LogLevel warn
Listen 80

Include module configuration:
IncludeOptional mods-enabled/*.load
IncludeOptional mods-enabled/*.conf

<Directory />
 AllowOverride None
 Require all denied
</Directory>

<Directory /var/www/html/>
 AllowOverride None
 Require all granted
</Directory>

<Directory /var/www/cgi-bin/>
 AddHandler cgi-script .cgi
 AllowOverride None
 Options +ExecCGI -MultiViews
 Require all granted
</Directory>

<VirtualHost *:80>
 DocumentRoot /var/www/html/
 ScriptAlias /cgi-bin/ /var/www/cgi-bin/
</VirtualHost>
EOF
```

## Install Docker Compose

With our web app developed, we're ready to containerize it. We'll install Docker Compose, pull in the two base images for the database and web server, and create our own containers with our web app files and configuration layered on top.

First, install what we'll need:

```
$ sudo apt-get update
$ sudo apt-get install -y docker.io docker-compose
```

## Create Database Container

Next, prepare the Postgres container. Each of Ubuntu's Docker Images has a git repository, referenced from the respective Docker Hub page. These repositories include some example content that we can build from:

```
$ git clone https://git.launchpad.net/~canonical-server/ubuntu-docker-images/+git/postgresql my-postgresql-oci
$ cd my-postgresql-oci/
$ git checkout origin/14-22.04 -b my-postgresql-oci-branch
$ find ./examples/ -type f
./examples/README.md
./examples/postgres-deployment.yml
./examples/docker-compose.yml
```



```
./examples/config/postgresql.conf
```

Notice the two YAML files. The `docker-compose.yml` file lets us create a derivative container where we can insert our own customizations such as config changes and our own SQL data to instantiate our database. (The other YAML file is for Kubernetes-based deployments.)

```
$ mv -iv ~/my-color-database.sql ./examples/
renamed '/home/ubuntu/my-color-database.sql' -> './examples/my-color-database.sql'
$ git add ./examples/my-color-database.sql
```

Modify the services section of the file `examples/docker-compose.yml` to look like this:

```
services:
 postgres:
 image: ubuntu/postgres:14-22.04_beta
 ports:
 - 5432:5432
 environment:
 - POSTGRES_PASSWORD=myS&cret
 volumes:
 - ./config/postgresql.conf:/etc/postgresql/postgresql.conf:ro
 - ./my-color-database.sql:/docker-entrypoint-initdb.d/my-color-database.sql:ro
```

The volumes section of the file lets us bind files from our local git repository into our new container. Things like the `postgresql.conf` configuration file get installed to the normal system as you'd expect.

But the `/docker-entrypoint-initdb.d/` directory will look unusual – this is a special directory provided by Ubuntu's Postgres Docker container that will automatically run `.sql` (or `.sql.gz` or `.sql.xz`) and `.sh` files through the `psql` interpreter during initialization, in POSIX alphanumerical order. In our case we have a single `.sql` file that we want invoked during initialization.

Ubuntu's ROCKs are also built with environment variables to customize behavior; above we can see where we can specify our own password.

Commit everything so far to our branch:

```
$ git commit -a -m "Add a color database definition"
[my-postgresql-oci-branch 0edeb20] Add a color database definition
2 files changed, 549 insertions(+)
create mode 100644 examples/my-color-database.sql
```

Now we're ready to create and start our application's database container:

```
$ cd ./examples/
$ sudo docker-compose up -d
Pulling postgres (ubuntu/postgres:edge)...
...
Creating examples_postgres_1 ... done

$ sudo docker-compose logs
...
postgres_1 | /usr/local/bin/docker-entrypoint.sh: running /docker-entrypoint-initdb.d/my-color-database.sql
...
postgres_1 | 2022-06-02 03:14:28.040 UTC [1] LOG: database system is ready to accept connections
```

The `-d` flag causes the container to run in the background (you might omit it if you want to run it in its own window so you can watch the service log info live.)

Note that if there is an error, such as a typo in your `.sql` file, you can't just re-run `docker-compose up` (or `restart`) because it'll attempt to re-attach and may appear successful at first glance:

```
...
postgres_1 | psql:/docker-entrypoint-initdb.d/my-color-database.sql:10: ERROR: type "sometypo" does not exist
postgres_1 | LINE 3: "id" SOMETYP0,
postgres_1 | ^
examples_postgres_1 exited with code 3

$ sudo docker-compose up
Starting examples_postgres_1 ... done
Attaching to examples_postgres_1
```

```

postgres_1 |
postgres_1 | PostgreSQL Database directory appears to contain a database; Skipping initialization
...
postgres_1 | 2022-06-02 04:00:51.400 UTC [25] LOG: database system was not properly shut down; automatic recovery in prog
...
postgres_1 | 2022-06-02 04:00:51.437 UTC [1] LOG: database system is ready to accept connections

```

However, while there is a live database, our data didn't load into it so it is invalid.

Instead, always issue a down command before attempting a restart when fixing issues:

```

$ sudo docker-compose down; sudo docker-compose up
...

```

Note that in our environment `docker-compose` needs to be run with root permissions; if it isn't, you may see an error similar to this:

```

ERROR: Couldn't connect to Docker daemon at http+docker://localhost - is it running?
If it's at a non-standard location, specify the URL with the DOCKER_HOST environment variable.

```

At this point we could move on to the webserver container, but we can double-check our work so far by installing the Postgres client locally in the VM and running a sample query:

```

$ sudo apt-get install postgresql-client
$ psql -h localhost -U postgres
Password for user postgres: myS&cret
postgres=# \d

 List of relations
Schema | Name | Type | Owner
-----+-----+-----+-----
public | color | table | postgres
public | color_id_seq | sequence | postgres
(2 rows)

postgres=# SELECT * FROM color WHERE id<4;
 id | red | green | blue | colorname
----+----+-----+-----+-----
 1 | 255 | 250 | 250 | snow
 2 | 248 | 248 | 255 | ghostwhite
 3 | 248 | 248 | 255 | GhostWhite
(3 rows)

```

## Create Webserver Docker Container

Now we do the same thing for the Apache2 webserver.

Get the example files from Canonical's Apache2 image repository via git:

```

$ cd ~
$ git clone https://git.launchpad.net/~canonical-server/ubuntu-docker-images/+git/apache2 my-apache2-oci
$ cd my-apache2-oci/
$ git checkout origin/2.4-22.04 -b my-apache2-oci-branch
$ find ./examples/ -type f
./examples/apache2-deployment.yml
./examples/README.md
./examples/docker-compose.yml
./examples/config/apache2.conf
./examples/config/html/index.html

$ mv -ivf ~/my-apache2.conf ./examples/config/apache2.conf
renamed '/home/ubuntu/my-apache2.conf' -> './examples/config/apache2.conf'
$ mv -iv ~/my-colors.cgi ./examples/
renamed '/home/ubuntu/my-colors.cgi' -> 'examples/my-colors.cgi'
$ chmod a+x ./examples/my-colors.cgi
$ git add ./examples/config/apache2.conf ./examples/my-colors.cgi

```

Modify the `examples/docker-compose.yml` file to look like this:

```

version: '2'

```

```
services:
 apache2:
 image: ubuntu/apache2:2.4-22.04_beta
 ports:
 - 8080:80
 volumes:
 - ./config/apache2.conf:/etc/apache2/apache2.conf:ro
 - ./config/html:/srv/www/html/index.html:ro
 - ./my-colors.cgi:/var/www/cgi-bin/my-colors.cgi:ro
 command: bash -c "apt-get update && apt-get -y install python3 python3-psycopp2; a2enmod cgid; apache2-
foreground"
 restart: always
```

Commit everything to the branch:

```
$ git commit -a -m "Add a color CGI web application"
```

Now launch the web server container:

```
$ cd ./examples/
$ sudo docker-compose up -d
```

You will now be able to connect to the service:

```
$ firefox http://localhost:8080/cgi-bin/my-colors.cgi?bgcolor=FFDEAD
```

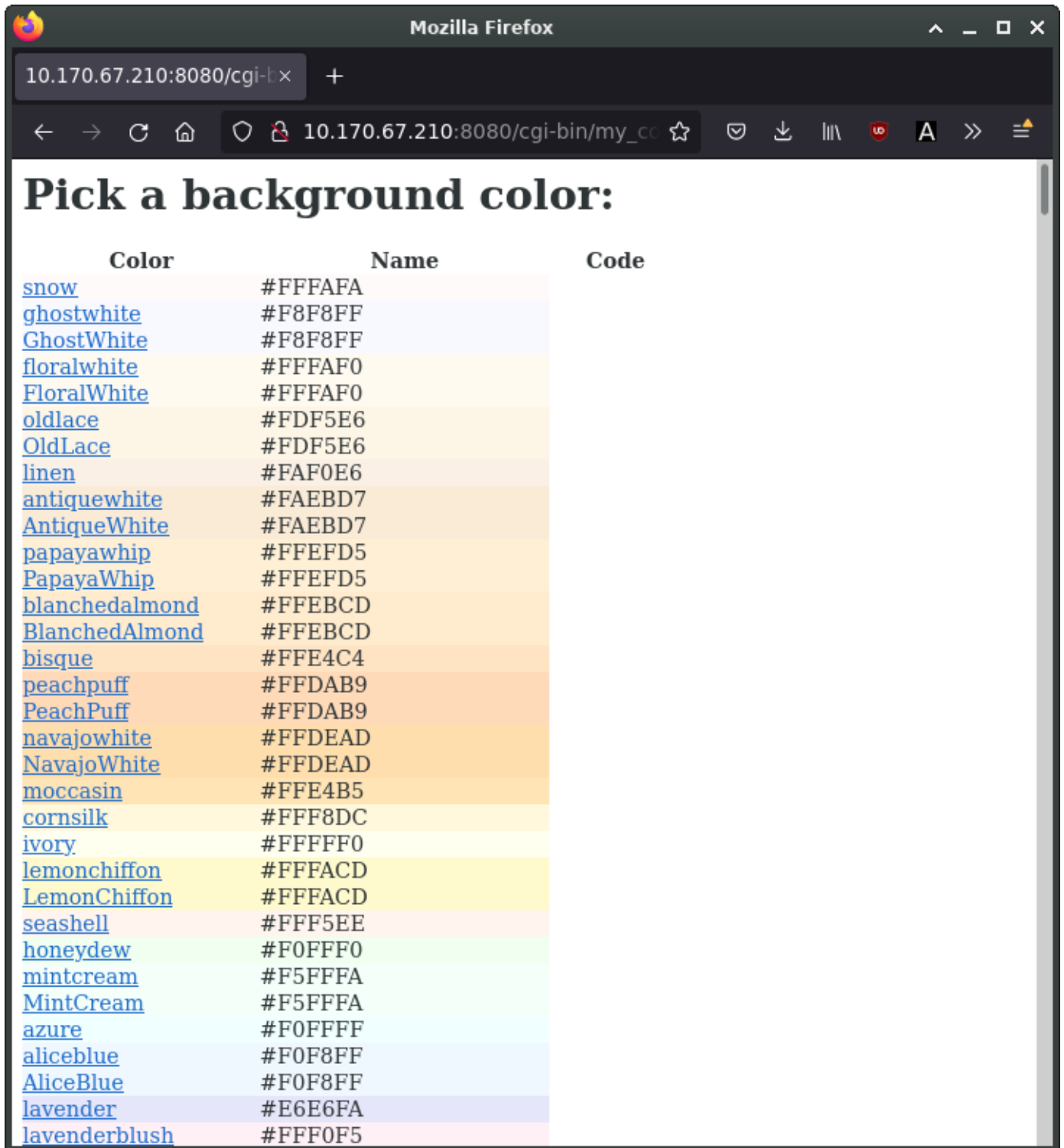

Click on one of the colors to see the background color change:

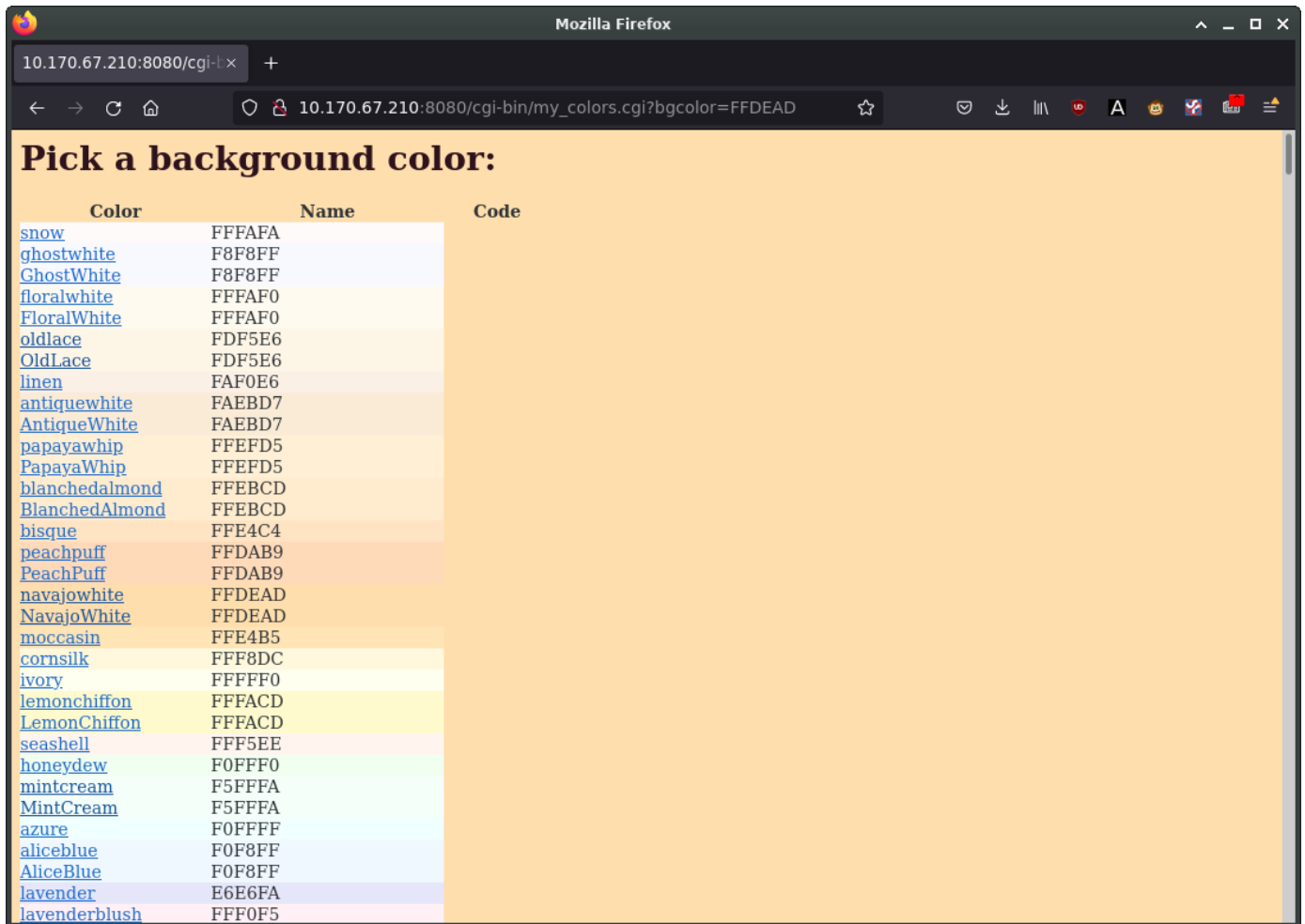

Once you're done, if you wish you can cleanup the containers as before, or if you used Multipass you can shutdown and delete the VM:

```
$ exit
host> multipass stop my-vm
host> multipass delete my-vm
```

## Next Steps

As you can see, docker-compose makes it convenient to set up multi-container applications without needing to perform runtime changes to the containers. As you can imagine, this can permit building a more sophisticated management system to handle fail-over, load-balancing, scaling, upgrading old nodes, and monitoring status. But rather than needing to implement all of this directly on top of docker-container, you can next investigate Kubernetes-style cluster management software such as [microk8s](#).

Ubuntu features a comprehensive package management system for installing, upgrading, configuring, and removing software. In addition to providing access to an organized base of over 60,000 software packages for your Ubuntu computer, the package management facilities also feature dependency resolution capabilities and software update checking.

Several tools are available for interacting with Ubuntu's package management system, from simple command-line utilities that can be easily automated by system administrators, to an easy-to-use graphical interface for those new to Ubuntu.

## Introduction

Ubuntu's package management system is derived from the same system used by the Debian GNU/Linux distribution. The package files contain all of the necessary files, metadata, and instructions to implement a particular functionality or software application on your Ubuntu computer.

Debian package files typically have the extension `.deb`, and usually exist in *repositories* which are collections of packages found online or on physical media, such as CD-ROM discs. Packages are normally in a pre-compiled binary format; thus installation is quick and requires no compiling of software.

Many packages use *dependencies*. Dependencies are additional packages required by the principal package in order to function properly. For example, the speech synthesis package `festival` depends upon the package `alsa-utils`, which is a package supplying the [Advanced Linux Sound Architecture \(ALSA\)](#) sound library tools needed for audio playback. In order for `festival` to function, it – and all of its dependencies – must be installed. The software management tools in Ubuntu will do this automatically.

## Advanced Packaging Tool – APT

The `apt` command is a powerful command-line tool, which works with Ubuntu's Advanced Packaging Tool (APT). The commands contained within `apt` provide the means for installing new software packages, upgrading existing software packages, updating the package list index, and even upgrading the entire Ubuntu system.

Some examples of popular uses for the `apt` utility include:

- **Install a Package**

Installation of packages using `apt` is quite simple. For example, to install the `nmap` network scanner, type the following:

```
sudo apt install nmap
```

**Tip**

You can specify multiple packages to be installed or removed, by separating them with spaces.

- **Remove a Package**

Removal of a package (or packages) is also straightforward. To remove the package installed in the previous example, simply type:

```
sudo apt remove nmap
```

Adding the `--purge` option to `apt remove` will remove the package configuration files as well. This may or may not be the desired effect, so use with caution.

**Note:**

While `apt` is a command-line tool, it is intended to be used interactively, and not to be called from non-interactive scripts. The `apt-get` command should be used in scripts (perhaps with the `--quiet` flag). For basic commands the syntax of the two tools is identical.

- **Update the package index**

The APT package index is essentially a database of available packages from the repositories defined in the `/etc/apt/sources.list` file and in the `/etc/apt/sources.list.d` directory. To update the local package index with the latest changes made in the repositories, type the following:

```
sudo apt update
```

- **Upgrade packages**

Installed packages on your computer may periodically have upgrades available from the package repositories (e.g., security updates). To upgrade your system, first, update your package index with `sudo apt update`, and then type:

```
sudo apt upgrade
```

For details on how to upgrade to a new Ubuntu release, see our [guide on upgrading](#).

Actions of the `apt` command, such as installation and removal of packages, are logged in the `/var/log/dpkg.log` log file.

For further information about the use of APT, read the comprehensive [APT User's Guide](#), or type `apt help`.

## Aptitude

Launching Aptitude with no command-line options will give you a menu-driven, text-based frontend to the APT system. Many of the common package management functions, such as installation, removal, and upgrade, can be performed in Aptitude with single-key commands, which are typically lowercase letters.

Aptitude is best suited for use in a non-graphical terminal environment to ensure proper functioning of the command keys. You can start the menu-driven interface of Aptitude as a normal user by typing the following command at a terminal prompt:

```
sudo aptitude
```

When Aptitude starts, you will see a menu bar at the top of the screen and two panes below the menu bar. The top pane contains package categories, such as *New Packages* and *Not Installed Packages*. The bottom pane contains information related to the packages and package categories.

Using Aptitude for package management is relatively straightforward, and the user interface makes common tasks simple to perform. The following are examples of common package management functions as performed in Aptitude:

- **Install Packages**

To install a package, locate it via the *Not Installed Packages* package category by using the keyboard arrow keys and the Enter key. Highlight the desired package, then press the + key. The package entry should turn *green*, indicating it has been marked for installation. Now press g to be presented with a summary of package actions. Press g again, and the package will be downloaded and installed. When finished, press Enter to return to the menu.

- **Remove Packages**

To remove a package, locate it in the *Installed Packages* package category by using the keyboard arrow keys and the Enter key. Highlight the package you want to remove, then press the - key. The package entry should turn *pink*, indicating it has been marked for removal. Now press g to be presented with a summary of package actions. Press g again, and the package will be removed. When finished, press Enter to return to the menu.

- **Update Package Index**

To update the package index, simply press the u key.

- **Upgrade Packages**

To upgrade packages, first update the package index as detailed above, and then press the U key to mark all packages with updates. Now press g, which will present you with a summary of package actions. Press g again to begin the download and installation. When finished, press Enter to return to the menu.

The first column of information displayed in the package list (in the top pane) lists the current state of the package (when viewing packages). It uses the following key to describe the package state:

- **i**: Installed package
- **c**: Package not installed, but package configuration remains on the system
- **p**: Purged from system
- **v**: Virtual package
- **B**: Broken package
- **u**: Unpacked files, but package not yet configured
- **C**: Half-configured - configuration failed and requires fix
- **H**: Half-installed - removal failed and requires a fix

To exit Aptitude, simply press the q key and confirm you wish to exit. Many other functions are available from the Aptitude menu by pressing the F10 key.

## Command Line Aptitude

You can also use Aptitude as a command-line tool, similar to `apt`. To install the `nmap` package with all necessary dependencies (as in the `apt` example), you would use the following command:

```
sudo aptitude install nmap
```

To remove the same package, you would use the command:

```
sudo aptitude remove nmap
```

Consult the Aptitude manpages for full details of Aptitude's command-line options.

## dpkg

`dpkg` is a package manager for *Debian*-based systems. It can install, remove, and build packages, but unlike other package management systems, it cannot automatically download and install packages – or their dependencies. **APT and Aptitude are newer, and layer additional features on top of dpkg.** This section covers using `dpkg` to manage locally installed packages:

- To list *all* packages in the system's package database, installed and uninstalled, from a terminal prompt type:

```
dpkg -l
```

- Depending on the number of packages on your system, this can generate a large amount of output. Pipe the output through `grep` to see if a specific package is installed:

```
dpkg -l | grep apache2
```

Replace `apache2` with any package name, part of a package name, or a regular expression.

- To list the files installed by a package, in this case the `ufw` package, enter:

```
dpkg -L ufw
```

- If you are unsure which package installed a file, `dpkg -S` may be able to tell you. For example:

```
dpkg -S /etc/host.conf
base-files: /etc/host.conf
```

The output shows that the `/etc/host.conf` belongs to the `base-files` package.

**Note:**

Many files are automatically generated during the package install process, and even though they are on the filesystem, `dpkg -S` may not know which package they belong to.

- You can install a local `.deb` file by entering:

```
sudo dpkg -i zip_3.0-4_amd64.deb
```

Change `zip_3.0-4_amd64.deb` to the actual file name of the local `.deb` file you wish to install.

- You can uninstall a package by:

```
sudo dpkg -r zip
```

**Caution:**

Uninstalling packages using `dpkg`, is *NOT* recommended in most cases. It is better to use a package manager that handles dependencies to ensure that the system is in a consistent state. For example, using `dpkg -r zip` will remove the `zip` package, but any packages that depend on it will still be installed and may no longer function correctly.

For more `dpkg` options see the manpage: `man dpkg`.

## APT configuration

Configuration of the APT system repositories is stored in the `/etc/apt/sources.list` file and the `/etc/apt/sources.list.d` directory. An example of this file is referenced here, along with information on adding or removing repository references from the file.

You can edit the file to enable and disable repositories. For example, to disable the requirement of inserting the Ubuntu CD-ROM whenever package operations occur, simply comment out the appropriate line for the CD-ROM, which appears at the top of the file:

```
no more prompting for CD-ROM please
deb cdrom:[DISTR0-APT-CD-NAME - Release i386 (20111013.1)]/ DISTR0-SHORT-CODENAME main restricted
```

## Extra repositories

In addition to the officially-supported package repositories available for Ubuntu, there are also community-maintained repositories which add thousands more packages for potential installation. Two of the most popular are the *universe* and *multiverse* repositories. These repositories are not officially supported by Ubuntu, but because they are maintained by the community they generally provide packages which are safe for use with your Ubuntu computer.

**Note:**

Packages in the *multiverse* repository often have licensing issues that prevent them from being distributed with a free operating system, and they may be illegal in your locality.

**Warning:**

Be advised that neither *universe* nor *multiverse* contain officially-supported packages. In particular, there may not be security updates for these packages.

Many other package sources are available – sometimes even offering only one package, as in the case of packages provided by the developer of a single application. You should always be very careful and cautious when using non-standard package sources/repos, however. Research the packages and their origins carefully before performing any installation, as some packages could render your system unstable or non-functional in some respects.



By default, the *universe* and *multiverse* repositories are enabled. If you would like to disable them, edit `/etc/apt/sources.list` and comment out the following lines:

```
deb http://archive.ubuntu.com/ubuntu DISTR0-SHORT-CODENAME universe multiverse
deb-src http://archive.ubuntu.com/ubuntu DISTR0-SHORT-CODENAME universe multiverse

deb http://us.archive.ubuntu.com/ubuntu/ DISTR0-SHORT-CODENAME universe
deb-src http://us.archive.ubuntu.com/ubuntu/ DISTR0-SHORT-CODENAME universe
deb http://us.archive.ubuntu.com/ubuntu/ DISTR0-SHORT-CODENAME-updates universe
deb-src http://us.archive.ubuntu.com/ubuntu/ DISTR0-SHORT-CODENAME-updates universe

deb http://us.archive.ubuntu.com/ubuntu/ DISTR0-SHORT-CODENAME multiverse
deb-src http://us.archive.ubuntu.com/ubuntu/ DISTR0-SHORT-CODENAME multiverse
deb http://us.archive.ubuntu.com/ubuntu/ DISTR0-SHORT-CODENAME-updates multiverse
deb-src http://us.archive.ubuntu.com/ubuntu/ DISTR0-SHORT-CODENAME-updates multiverse

deb http://security.ubuntu.com/ubuntu DISTR0-SHORT-CODENAME-security universe
deb-src http://security.ubuntu.com/ubuntu DISTR0-SHORT-CODENAME-security universe
deb http://security.ubuntu.com/ubuntu DISTR0-SHORT-CODENAME-security multiverse
deb-src http://security.ubuntu.com/ubuntu DISTR0-SHORT-CODENAME-security multiverse
```

## Automatic updates

The `unattended-upgrades` package can be used to automatically install updated packages and can be configured to update all packages or just install security updates. First, install the package by entering the following in a terminal:

```
sudo apt install unattended-upgrades
```

To configure `unattended-upgrades`, edit `/etc/apt/apt.conf.d/50unattended-upgrades` and adjust the following to fit your needs:

```
Unattended-Upgrade::Allowed-Origins {
 "${distro_id}:${distro_codename}";
 "${distro_id}:${distro_codename}-security";
 // "${distro_id}:${distro_codename}-updates";
 // "${distro_id}:${distro_codename}-proposed";
 // "${distro_id}:${distro_codename}-backports";
};
```

Certain packages can also be excluded and therefore will not be automatically updated. To block a package, add it to the list:

```
Unattended-Upgrade::Package-Blacklist {
 // "vim";
 // "libc6";
 // "libc6-dev";
 // "libc6-i686";
};
```

### Note:

The double `“//”` serve as comments, so whatever follows `“//”` will not be evaluated.

To enable automatic updates, edit `/etc/apt/apt.conf.d/20auto-upgrades` and set the appropriate APT configuration options:

```
APT::Periodic::Update-Package-Lists "1";
APT::Periodic::Download-Upgradeable-Packages "1";
APT::Periodic::AutocleanInterval "7";
APT::Periodic::Unattended-Upgrade "1";
```

The above configuration updates the package list, downloads, and installs available upgrades every day. These actions are triggered by timer units at a set time but with a random delay: `apt-daily.timer` and `apt-daily-upgrade.timer`. These timers activate the correspondent services that run the `/usr/lib/apt/apt.systemd.daily` script.

However, it may happen that if the server is off at the time the timer unit elapses, the timer will be triggered immediately at the next startup. As a result, they will often run on system startup and thereby cause immediate activity and hold the `apt-lock`.

In many cases this is beneficial, but in some cases it might be counter-productive; examples are administrators with many shut-down machines or VM images that are only started for some quick action, which is delayed or even blocked by the unattended upgrades. To adapt this behaviour, we can change/override the configuration of both APT's timer units [`apt-daily-upgrade.timer`, `apt-daily.timer`]. To do so, use `systemctl edit <timer_unit>` and override the *Persistent* attribute, for example with `Persistent=delay`:

```
[Timer]
Persistent=delay
```

The local download archive is cleaned every week. On servers upgraded to newer versions of Ubuntu, depending on your responses, the file listed above may not be there. In this case, creating a new file of the same name should also work.

**Note:**

You can read more about `apt` *Periodic* configuration options in the `apt.conf(5)` manpage and in the `/usr/lib/apt/apt.systemd.daily` script header.

The results of `unattended-upgrades` will be logged to `/var/log/unattended-upgrades`.

## Notifications

Configuring `Unattended-Upgrade::Mail` in `/etc/apt/apt.conf.d/50unattended-upgrades` will enable `unattended-upgrades` to email an administrator detailing any packages that need upgrading or have problems.

Another useful package is `apticron`. `apticron` will configure a cron job to email an administrator information about any packages on the system that have updates available, as well as a summary of changes in each package.

To install the `apticron` package, enter the following command in a terminal:

```
sudo apt install apticron
```

Once the package is installed, edit `/etc/apticron/apticron.conf`, to set the email address and other options:

```
EMAIL="root@example.com"
```

## References

Most of the material covered in this chapter is available in man pages, many of which are available online.

- The [Installing Software Ubuntu](#) wiki page has more information.
- For more `dpkg` details see the [dpkg man page](#).
- The [APT User's Guide](#) and [apt man page](#) contain useful information regarding APT usage.
- For more info about `systemd` timer units (and `systemd` in general), visit the [systemd man page](#) and [systemd.timer man page](#).
- See the [Aptitude user's manual](#) for more Aptitude options.
- The [Adding Repositories HOWTO \(Ubuntu Wiki\)](#) page contains more details on adding repositories.

This article details how to upgrade an Ubuntu Server or Ubuntu cloud image to the next release.

## Upgrade paths

Ubuntu supports the ability to upgrade from one LTS to the next LTS in sequential order. For example, a user on Ubuntu 16.04 LTS can upgrade to Ubuntu 18.04 LTS, but cannot jump directly to Ubuntu 20.04 LTS. To do this, the user would need to upgrade twice: once to Ubuntu 18.04 LTS, and then upgrade again to Ubuntu 20.04 LTS.

It is recommended that users run an LTS release as it provides 5 years of standard support and security updates. After the initial standard support, an extended support period is available via an [Ubuntu Pro](#) subscription.

For a complete list of releases and current support status see the [Ubuntu Wiki Releases](#) page.

## Upgrade checklist

To ensure a successful upgrade, please review the following items:

- Check the release notes for the new release for any known issues or important changes. Release notes for each release are found on the [Ubuntu Wiki Releases](#) page.

- Fully update the system. The upgrade process works best when the current system has all the latest updates installed. Users should confirm that these commands complete successfully and that no further updates are available. It is also suggested that users reboot the system after all the updates are applied to verify they are running the latest kernel. To upgrade run the following commands:

```
sudo apt update
sudo apt upgrade
```

- Users should check that there is sufficient free disk space for the upgrade. Upgrading a system will make your system download new packages, which is likely to be on the order of hundreds of new packages. Systems with additional software installed may therefore require a few gigabytes of free disk space.
- The upgrade process takes time to complete. Users should have dedicated time to participate in the upgrade process.
- Third-party software repositories and personal package archives (PPAs) are disabled during the upgrade. However, any software installed from these repositories is not removed or downgraded. Software installed from these repositories is the single most common cause of upgrade issues.
- Backup any and all data. Although upgrades are normally safe, there is always a chance that something may go wrong. It is extremely important that the data is safely copied to a backup location to allow restoration if there are any problems or complications during the upgrade process.

## Upgrade

It is recommended to upgrade the system using the `do-release-upgrade` command on Server edition and cloud images. This command can handle system configuration changes that are sometimes needed between releases.

### **do-release-upgrade**

To begin the process run the following command:

```
sudo do-release-upgrade
```

Upgrading to a development release of Ubuntu is available using the `-d` flag. However, using the development release (or this flag) is not recommended for production environments.

Upgrades from one LTS to the next LTS release are only available after the first point release. For example, Ubuntu 18.04 LTS will only upgrade to Ubuntu 20.04 LTS after the 20.04.1 point release. If users wish to update before the point release (e.g., on a subset of machines to evaluate the LTS upgrade) users can force the upgrade via the `-d` flag.

### **Pre-upgrade summary**

Before making any changes the command will first do some checks to verify the system is ready to update. The user will be prompted with a summary of the upgrade before proceeding. If the user accepts the changes, the process will begin to update the system's packages:

```
Do you want to start the upgrade?
```

```
5 installed packages are no longer supported by Canonical. You can
still get support from the community.
```

```
4 packages are going to be removed. 117 new packages are going to be
installed. 424 packages are going to be upgraded.
```

```
You have to download a total of 262 M. This download will take about
33 minutes with a 1Mbit DSL connection and about 10 hours with a 56k
modem.
```

```
Fetching and installing the upgrade can take several hours. Once the
download has finished, the process cannot be canceled.
```

```
Continue [yN] Details [d]
```

## Configuration changes

It is possible during the upgrade process the user gets presented with a message to make decisions about package updates. These prompts occur when there are existing configuration files edited by the user and the new package configuration file are different. Below is an example prompt:

```
Configuration file '/etc/ssh/ssh_config'
==> Modified (by you or by a script) since installation.
==> Package distributor has shipped an updated version.
 What would you like to do about it ? Your options are:
 Y or I : install the package maintainer's version
 N or O : keep your currently-installed version
 D : show the differences between the versions
 Z : start a shell to examine the situation
 The default action is to keep your current version.
*** ssh_config (Y/I/N/O/D/Z) [default=N] ?
```

Users should look at the differences between the files and decide what to do. The default response is to keep the current version of the file. There are situations where accepting the new version, like with `/boot/grub/menu.lst`, is required for the system to boot correctly with the new kernel.

## Package removal

After all packages are updated the user will again remove any obsolete, no longer needed, packages:

```
Remove obsolete packages?
```

```
30 packages are going to be removed.
```

```
Continue [yN] Details [d]
```

## Reboot

Finally, when the upgrade is complete the user is prompted to reboot the system. The system is not considered upgraded until a reboot occurs:

```
System upgrade is complete.
```

```
Restart required
```

```
To finish the upgrade, a restart is required.
If you select 'y' the system will be restarted.
```

```
Continue [yN]
```

The Ubuntu Project, and thus Ubuntu Server, uses [Launchpad](#) as its bug tracker. In order to file a bug, you will need a Launchpad account. [Create one here](#) if necessary.

## Reporting bugs with `apport-cli`

The preferred way to report a bug is with the `apport-cli` command. It must be invoked on the machine affected by the bug because it collects information from the system on which it is being run and publishes it to the bug report on Launchpad. Getting that information to Launchpad can, therefore, be a challenge if the system is not running a desktop environment in order to use a browser (common with servers) or if it does not have Internet access. The steps to take in these situations are described below.

### Note:

The commands `apport-cli` and `ubuntu-bug` should give the same results on a command-line interface (CLI) server. The latter is actually a symlink to `apport-bug` which is intelligent enough to know whether a desktop environment is in use, and will choose `apport-cli` if not. Since server systems tend to be CLI-only `apport-cli` was chosen from the outset in this guide.

Bug reports in Ubuntu need to be filed against a specific software package, so the name of the package (source package or program name/path) affected by the bug needs to be supplied to `apport-cli`:

```
apport-cli PACKAGENAME
```

Once `apport-cli` has finished gathering information you will be asked what to do with it. For instance, to report a bug in vim using `apport-cli vim` produces output like this:

```
*** Collecting problem information
```

```
The collected information can be sent to the developers to improve the
application. This might take a few minutes.
```

```
...
```

```
*** Send problem report to the developers?
```

```
After the problem report has been sent, please fill out the form in the
automatically opened web browser.
```

```
What would you like to do? Your options are:
```

```
S: Send report (2.8 KB)
```

```
V: View report
```

```
K: Keep report file for sending later or copying to somewhere else
```

```
I: Cancel and ignore future crashes of this program version
```

```
C: Cancel
```

```
Please choose (S/V/K/I/C):
```

The first three options are described below:

- **S: Send report**

Submits the collected information to Launchpad as part of the process of filing a new bug report. You will be given the opportunity to describe the bug in your own words.

```
*** Uploading problem information
```

```
The collected information is being sent to the bug tracking system.
```

```
This might take a few minutes.
```

```
94%
```

```
*** To continue, you must visit the following URL:
```

```
https://bugs.launchpad.net/ubuntu/+source/vim/+filebug/09b2495a-e2ab-11e3-879b-68b5996a96c8?
```

```
You can launch a browser now, or copy this URL into a browser on another computer.
```

```
Choices:
```

```
1: Launch a browser now
```

```
C: Cancel
```

```
Please choose (1/C): 1
```

The browser that will be used when choosing '1' will be the one known on the system as `www-browser` via the [Debian alternatives system](#). Examples of text-based browsers to install include `links`, `elinks`, `lynx`, and `w3m`. You can also manually point an existing browser at the given URL.

- **V: View**

Displays the collected information on the screen for review. This can be a lot of information. Press `Enter` to scroll through the screens. Press `q` to quit and return to the choice menu.

- **K: Keep**

Writes the collected information to disk. The resulting file can be later used to file the bug report, typically after transferring it to another Ubuntu system.

```
What would you like to do? Your options are:
```

```
S: Send report (2.8 KB)
```

```
V: View report
```

```
K: Keep report file for sending later or copying to somewhere else
```

```
I: Cancel and ignore future crashes of this program version
```

```
C: Cancel
```

```
Please choose (S/V/K/I/C): k
```

```
Problem report file: /tmp/apport.vim.lpg92p02.apport
```

To report the bug, get the file onto an Internet-enabled Ubuntu system and apply `apport-cli` to it. This will cause the menu to appear immediately (the information is already collected). You should then press `s` to send:

```
apport-cli apport.vim.1pg92p02.apport
```

To directly save a report to disk (without menus) you can run:

```
apport-cli vim --save apport.vim.test.apport
```

Report names should end in `.apport`.

**Note:**

If this Internet-enabled system is non-Ubuntu/Debian, `apport-cli` is not available so the bug will need to be created manually. An `apport` report is also not to be included as an attachment to a bug either so it is completely useless in this scenario.

## Reporting application crashes

The software package that provides the `apport-cli` utility, `apport`, can be configured to automatically capture the state of a crashed application. This is enabled by default (in `/etc/default/apport`).

After an application crashes, if enabled, `apport` will store a crash report under `/var/crash`:

```
-rw-r----- 1 peter whoopsie 150K Jul 24 16:17 _usr_lib_x86_64-linux-gnu_libmenu-cache2_libexec_menu-
cached.1000.crash
```

Use the `apport-cli` command without arguments to process any pending crash reports. It will offer to report them one by one, as in the following example:

```
apport-cli
```

```
*** Send problem report to the developers?
```

After the problem report has been sent, please fill out the form in the automatically opened web browser.

What would you like to do? Your options are:

- S: Send report (153.0 KB)
- V: View report
- K: Keep report file for sending later or copying to somewhere else
- I: Cancel and ignore future crashes of this program version
- C: Cancel

Please choose (S/V/K/I/C): `s`

If you send the report, as was done above, the prompt will be returned immediately and the `/var/crash` directory will then contain 2 extra files:

```
-rw-r----- 1 peter whoopsie 150K Jul 24 16:17 _usr_lib_x86_64-linux-gnu_libmenu-cache2_libexec_menu-
cached.1000.crash
-rw-rw-r-- 1 peter whoopsie 0 Jul 24 16:37 _usr_lib_x86_64-linux-gnu_libmenu-cache2_libexec_menu-
cached.1000.upload
-rw----- 1 whoopsie whoopsie 0 Jul 24 16:37 _usr_lib_x86_64-linux-gnu_libmenu-cache2_libexec_menu-
cached.1000.uploaded
```

Sending in a crash report like this will not immediately result in the creation of a new public bug. The report will be made private on Launchpad, meaning that it will be visible to only a limited set of bug triagers. These triagers will then scan the report for possible private data before creating a public bug.

## Resources

- See the [Reporting Bugs Ubuntu](#) wiki page.
- Also, [the Apport page](#) has some useful information. Though some of it pertains to using a GUI.

A 'kernel crash dump' refers to a portion of the contents of volatile memory (RAM) that is copied to disk whenever the execution of the kernel is disrupted. The following events can cause a kernel disruption:

- Kernel panic
- Non-maskable interrupts (NMI)
- Machine check exceptions (MCE)

- Hardware failure
- Manual intervention

For some of these events (kernel panic, NMI) the kernel will react automatically and trigger the crash dump mechanism through *kexec*. In other situations a manual intervention is required in order to capture the memory. Whenever one of the above events occurs, it is important to find out the root cause in order to prevent it from happening again. The cause can be determined by inspecting the copied memory contents.

## Kernel crash dump mechanism

When a kernel panic occurs, the kernel relies on the *kexec* mechanism to quickly reboot a new instance of the kernel in a pre-reserved section of memory that had been allocated when the system booted (see below). This permits the existing memory area to remain untouched in order to safely copy its contents to storage.

## Installation

The kernel crash dump utility is installed with the following command:

```
sudo apt install linux-crashdump
```

**Note:**

Starting with 16.04, the kernel crash dump mechanism is enabled by default.

During the installation, you will be prompted with the following dialogs.

```
|-----| Configuring kexec-tools |-----|
|
| If you choose this option, a system reboot will trigger a restart into a
| kernel loaded by kexec instead of going through the full system boot
| loader process.
|
| Should kexec-tools handle reboots (sysvinit only)?
|
| <Yes> <No>
|-----|
```

Select 'Yes' to select kexec-tools for all reboots.

```
|-----| Configuring kdump-tools |-----|
|
| If you choose this option, the kdump-tools mechanism will be enabled. A
| reboot is still required in order to enable the crashkernel kernel
| parameter.
|
| Should kdump-tools be enabled be default?
|
| <Yes> <No>
|-----|
```

'Yes' should be selected here as well, to enable kdump-tools.

If you ever need to manually enable the functionality, you can use the `dpkg-reconfigure kexec-tools` and `dpkg-reconfigure kdump-tools` commands and answer 'Yes' to the questions. You can also edit `/etc/default/kexec` and set parameters directly:

```
Load a kexec kernel (true/false)
LOAD_KEXEC=true
```

As well, edit `/etc/default/kdump-tools` to enable kdump by including the following line:

```
USE_KDUMP=1
```

If a reboot has not been done since installation of the `linux-crashdump` package, a reboot will be required in order to activate the `crashkernel= boot` parameter. Upon reboot, `kdump-tools` will be enabled and active.

If you enable `kdump-tools` after a reboot, you will only need to issue the `kdump-config load` command to activate the `kdump` mechanism.

You can view the current status of `kdump` via the command `kdump-config show`. This will display something like this:

```
DUMP_MODE: kdump
USE_KDUMP: 1
KDUMP_SYSCTL: kernel.panic_on_oops=1
KDUMP_COREDIR: /var/crash
crashkernel addr:
 /var/lib/kdump/vmlinuz
kdump initrd:
 /var/lib/kdump/initrd.img
current state: ready to kdump
kexec command:
 /sbin/kexec -p --command-line="..." --initrd=...
```

This tells us that we will find core dumps in `/var/crash`.

## Configuration

In addition to local dump, it is now possible to use the remote dump functionality to send the kernel crash dump to a remote server, using either the SSH or NFS protocols.

### Local kernel crash dumps

Local dumps are configured automatically and will remain in use unless a remote protocol is chosen. Many configuration options exist and are thoroughly documented in the `/etc/default/kdump-tools` file.

### Remote kernel crash dumps using the SSH protocol

To enable remote dumps using the SSH protocol, the `/etc/default/kdump-tools` must be modified in the following manner:

```

Remote dump facilities:
SSH - username and hostname of the remote server that will receive the dump
and dmesg files.
SSH_KEY - Full path of the ssh private key to be used to login to the remote
server. use kdump-config propagate to send the public key to the
remote server
HOSTTAG - Select if hostname of IP address will be used as a prefix to the
timestamped directory when sending files to the remote server.
'ip' is the default.
SSH="ubuntu@kdump-netcrash"
```

The only mandatory variable to define is `SSH`. It must contain the username and hostname of the remote server using the format `{username}@{remote server}`.

`SSH_KEY` may be used to provide an existing private key to be used. Otherwise, the `kdump-config propagate` command will create a new keypair. The `HOSTTAG` variable may be used to use the hostname of the system as a prefix to the remote directory to be created instead of the IP address.

The following example shows how `kdump-config propagate` is used to create and propagate a new keypair to the remote server:

```
sudo kdump-config propagate
```

Which produces an output like this:

```
Need to generate a new ssh key...
The authenticity of host 'kdump-netcrash (192.168.1.74)' can't be established.
ECDSA key fingerprint is SHA256:iMp+5Y28qhbd+tevFCWrEXykDd4dI3yN40Vlu3CBBQ4.
Are you sure you want to continue connecting (yes/no)? yes
ubuntu@kdump-netcrash's password:
propagated ssh key /root/.ssh/kdump_id_rsa to server ubuntu@kdump-netcrash
```

The password of the account used on the remote server will be required in order to successfully send the public key to the server.



The `kdump-config show` command can be used to confirm that `kdump` is correctly configured to use the SSH protocol:

```
kdump-config show
```

Whose output appears like this:

```
DUMP_MODE: kdump
USE_KDUMP: 1
KDUMP_SYSCTL: kernel.panic_on_oops=1
KDUMP_COREDIR: /var/crash
crashkernel addr: 0x2c000000
 /var/lib/kdump/vmlinuz: symbolic link to /boot/vmlinuz-4.4.0-10-generic
kdump initrd:
 /var/lib/kdump/initrd.img: symbolic link to /var/lib/kdump/initrd.img-4.4.0-10-generic
SSH: ubuntu@kdump-netcrash
SSH_KEY: /root/.ssh/kdump_id_rsa
HOSTTAG: ip
current state: ready to kdump
```

## Remote kernel crash dumps using the NFS protocol

To enable remote dumps using the NFS protocol, the `/etc/default/kdump-tools` must be modified in the following manner:

```
NFS - Hostname and mount point of the NFS server configured to receive
the crash dump. The syntax must be {HOSTNAME}:{MOUNTPOINT}
(e.g. remote:/var/crash)
#
NFS="kdump-netcrash:/var/crash"
```

As with the SSH protocol, the `HOSTTAG` variable can be used to replace the IP address by the hostname as the prefix of the remote directory.

The `kdump-config show` command can be used to confirm that `kdump` is correctly configured to use the NFS protocol :

```
kdump-config show
```

Which produces an output like this:

```
DUMP_MODE: kdump
USE_KDUMP: 1
KDUMP_SYSCTL: kernel.panic_on_oops=1
KDUMP_COREDIR: /var/crash
crashkernel addr: 0x2c000000
 /var/lib/kdump/vmlinuz: symbolic link to /boot/vmlinuz-4.4.0-10-generic
kdump initrd:
 /var/lib/kdump/initrd.img: symbolic link to /var/lib/kdump/initrd.img-4.4.0-10-generic
NFS: kdump-netcrash:/var/crash
HOSTTAG: hostname
current state: ready to kdump
```

## Verification

To confirm that the kernel dump mechanism is enabled, there are a few things to verify. First, confirm that the `crashkernel` boot parameter is present (note that the following line has been split into two to fit the format of this document):

```
cat /proc/cmdline
```

```
BOOT_IMAGE=/vmlinuz-3.2.0-17-server root=/dev/mapper/PreciseS-root ro
 crashkernel=384M-2G:64M,2G-:128M
```

The `crashkernel` parameter has the following syntax:

```
crashkernel=<range1>:<size1>[,<range2>:<size2>,...][@offset]
 range=start-[end] 'start' is inclusive and 'end' is exclusive.
```

So for the `crashkernel` parameter found in `/proc/cmdline` we would have :

```
crashkernel=384M-2G:64M,2G-:128M
```

The above value means:

- if the RAM is smaller than 384M, then don't reserve anything (this is the "rescue" case)
- if the RAM size is between 386M and 2G (exclusive), then reserve 64M
- if the RAM size is larger than 2G, then reserve 128M

Second, verify that the kernel has reserved the requested memory area for the `kdump` kernel by running:

```
dmesg | grep -i crash
```

Which produces the following output in this case:

```
...
[0.000000] Reserving 64MB of memory at 800MB for crashkernel (System RAM: 1023MB)
```

Finally, as seen previously, the `kdump-config show` command displays the current status of the `kdump-tools` configuration :

```
kdump-config show
```

Which produces:

```
DUMP_MODE: kdump
USE_KDUMP: 1
KDUMP_SYSCTL: kernel.panic_on_oops=1
KDUMP_COREDIR: /var/crash
crashkernel addr: 0x2c000000
 /var/lib/kdump/vmlinuz: symbolic link to /boot/vmlinuz-4.4.0-10-generic
kdump initrd:
 /var/lib/kdump/initrd.img: symbolic link to /var/lib/kdump/initrd.img-4.4.0-10-generic
current state: ready to kdump
```

kexec command:

```
/sbin/kexec -p --command-line="BOOT_IMAGE=/vmlinuz-4.4.0-10-generic root=/dev/mapper/VividS--vg-
root ro debug break=init console=ttyS0,115200 irqpoll maxcpus=1 nousb systemd.unit=kdump-tools.service" --
initrd=/var/lib/kdump/initrd.img /var/lib/kdump/vmlinuz
```

## Testing the crash dump mechanism

### Warning:

Testing the crash dump mechanism **will cause a system reboot**. In certain situations, this can cause data loss if the system is under heavy load. If you want to test the mechanism, make sure that the system is idle or under very light load.

Verify that the *SysRQ* mechanism is enabled by looking at the value of the `/proc/sys/kernel/sysrq` kernel parameter:

```
cat /proc/sys/kernel/sysrq
```

If a value of `0` is returned, the dump and then reboot feature is disabled. A value greater than `1` indicates that a sub-set of `sysrq` features is enabled. See `/etc/sysctl.d/10-magic-sysrq.conf` for a detailed description of the options and their default values. Enable dump then reboot testing with the following command:

```
sudo sysctl -w kernel.sysrq=1
```

Once this is done, you must become root, as just using `sudo` will not be sufficient. As the `root` user, you will have to issue the command `echo c > /proc/sysrq-trigger`. If you are using a network connection, you will lose contact with the system. This is why it is better to do the test while being connected to the system console. This has the advantage of making the kernel dump process visible.

A typical test output should look like the following :

```
sudo -s
[sudo] password for ubuntu:
echo c > /proc/sysrq-trigger
[31.659002] SysRq : Trigger a crash
[31.659749] BUG: unable to handle kernel NULL pointer dereference at (null)
[31.662668] IP: [<ffffffff8139f166>] sysrq_handle_crash+0x16/0x20
[31.662668] PGD 3bfb9067 PUD 368a7067 PMD 0
[31.662668] Oops: 0002 [#1] SMP
[31.662668] CPU 1
```

....

The rest of the output is truncated, but you should see the system rebooting and somewhere in the log, you will see the following line :

```
Begin: Saving vmcore from kernel crash ...
```

Once completed, the system will reboot to its normal operational mode. You will then find the kernel crash dump file, and related subdirectories, in the `/var/crash` directory by running, e.g. `ls /var/crash` , which produces the following:

```
201809240744 kexec_cmd linux-image-4.15.0-34-generic-201809240744.crash
```

If the dump does not work due to an ‘out of memory’ (OOM) error, then try increasing the amount of reserved memory by editing `/etc/default/grub.d/kdump-tools.cfg`. For example, to reserve 512 megabytes:

```
GRUB_CMDLINE_LINUX_DEFAULT="$GRUB_CMDLINE_LINUX_DEFAULT crashkernel=384M-:512M"
```

You can then run `sudo update-grub`, reboot afterwards, and then test again.

## Resources

Kernel crash dump is a vast topic that requires good knowledge of the Linux kernel. You can find more information on the topic here:

- [Kdump kernel documentation](#).
- [Analyzing Linux Kernel Crash](#) (Based on Fedora, it still gives a good walkthrough of kernel dump analysis)

The Lightweight Directory Access Protocol, or LDAP, is a protocol for querying and modifying a X.500-based directory service running over TCP/IP. The current LDAP version is LDAPv3, as defined in [RFC 4510](#), and the implementation used in Ubuntu is OpenLDAP.

The LDAP protocol *accesses* directories. It’s common to refer to a directory an *LDAP directory* or *LDAP database* as a shorthand – although technically incorrect, this shorthand is so widely used that it’s understood as such.

## Key concepts and terms

- A directory is a tree of data *entries* that is hierarchical in nature and is called the Directory Information Tree (DIT).
- An entry consists of a set of *attributes*.
- An attribute has a *key* (a name/description) and one or more *values*.
- Every attribute must be defined in at least one *objectClass*.
- Attributes and objectClasses are defined in *schemas* (an objectClass is considered as a special kind of attribute).
- Each entry has a unique identifier: its *Distinguished Name* (DN or dn). This, in turn, consists of a *Relative Distinguished Name* (RDN) followed by the parent entry’s DN.
- The entry’s DN is not an attribute. It is not considered part of the entry itself.

### Note:

The terms *object*, *container*, and *node* have certain connotations but they all essentially mean the same thing as *entry* (the technically correct term).

For example, below we have a single entry consisting of 11 attributes where the following is true:

- DN is “cn=John Doe,dc=example,dc=com”
- RDN is “cn=John Doe”
- parent DN is “dc=example,dc=com”

```
dn: cn=John Doe,dc=example,dc=com
cn: John Doe
givenName: John
sn: Doe
telephoneNumber: +1 888 555 6789
telephoneNumber: +1 888 555 1232
mail: john@example.com
manager: cn=Larry Smith,dc=example,dc=com
objectClass: inetOrgPerson
```

```
objectClass: organizationalPerson
objectClass: person
objectClass: top
```

The above entry is in *LDIF* format (LDAP Data Interchange Format). Any information that you feed into your DIT must also be in such a format. It is defined in [RFC 2849](#).

Such a directory accessed via LDAP is good for anything that involves a large number of access requests to a mostly-read, attribute-based (name:value) backend, and that can benefit from a hierarchical structure. Examples include an address book, company directory, a list of email addresses, and a mail server's configuration.

## References

- [The OpenLDAP administrators guide](#)
- [RFC 4515: LDAP string representation of search filters](#)
- [Zytrax's LDAP for Rocket Scientists](#); a less pedantic but comprehensive treatment of LDAP

Older references that might still be useful:

- O'Reilly's [LDAP System Administration](#) (textbook; 2003)
- Packt's [Mastering OpenLDAP](#) (textbook; 2007)

The installation of `slapd` (the Stand-alone LDAP Daemon) will create a minimal working configuration with a top level entry, and an administrator's Distinguished Name (DN). In particular, it will create a database instance that you can use to store your data. However, the suffix (or base DN) of this instance will be determined from the domain name of the host. If you want something different, you can change it right after the installation when you still don't have any useful data.

### Note:

This guide will use a database suffix of `dc=example,dc=com`.

Proceed with the install of the server and the main command line utilities:

```
sudo apt install slapd ldap-utils
```

If you want to change your Directory Information Tree (DIT) suffix, now would be a good time since changing it discards your existing one. To change the suffix, run the following command:

```
sudo dpkg-reconfigure slapd
```

To switch your DIT suffix to `dc=example,dc=com`, for example, so you can follow this guide more closely, answer `example.com` when asked about the DNS domain name.

Throughout this guide we will issue many commands with the LDAP utilities. To save some typing, we can configure the OpenLDAP libraries with certain defaults in `/etc/ldap/ldap.conf` (adjust these entries for your server name and directory suffix):

```
BASE dc=example,dc=com
URI ldap://ldap01.example.com
```

## The default DIT

The packaging of `slapd` is designed to be configured within the service itself by dedicating a separate DIT for that purpose. This allows one to dynamically configure `slapd` without needing to restart the service or edit config files. This configuration database consists of a collection of text-based LDIF files located under `/etc/ldap/slapd.d`, but these should never be edited directly. This way of working is known by several names: the *slapd-config* method, the Real Time Configuration (RTC) method, or the *cn=config* method. You can still use the traditional flat-file method (`slapd.conf`) but that will not be covered in this guide.

Right after installation, you will get two databases, or suffixes: one for your data, based on your host's domain (`dc=example,dc=com`), and one for your configuration, with its root at *cn=config*. To change the data on each we need different credentials and access methods:

- *dc=example,dc=com*  
The administrative user for this suffix is *cn=admin,dc=example,dc=com* and its password is the one selected during the installation of the `slapd` package.
- *cn=config*  
The configuration of `slapd` itself is stored under this suffix. Changes to it can be made by the special DN *gidNumber=0+uidNumber=0,cn=peercred,cn=external,cn=auth*. This is how the local system's root user (`uid=0/gid=0`)

is seen by the directory when using SASL EXTERNAL authentication through the `ldapi:///` transport via the `/run/slaped/ldapi` Unix socket. Essentially what this means is that only the local root user can update the `cn=config` database. More details later.

- This is what the `slaped-config` DIT looks like via the LDAP protocol (listing only the DNs):

```
$ sudo ldapsearch -Q -LLL -Y EXTERNAL -H ldapi:/// -b cn=config dn
dn: cn=config
```

```
dn: cn=module{0},cn=config
```

```
dn: cn=schema,cn=config
```

```
dn: cn={0}core,cn=schema,cn=config
```

```
dn: cn={1}cosine,cn=schema,cn=config
```

```
dn: cn={2}nis,cn=schema,cn=config
```

```
dn: cn={3}inetorgperson,cn=schema,cn=config
```

```
dn: olcDatabase={-1}frontend,cn=config
```

```
dn: olcDatabase={0}config,cn=config
```

```
dn: olcDatabase={1}mdb,cn=config
```

Explanation of entries:

- `cn=config`: Global settings
- `cn=module{0},cn=config`: A dynamically loaded module
- `cn=schema,cn=config`: Contains hard-coded system-level schema
- `cn={0}core,cn=schema,cn=config`: The hard-coded *core* schema
- `cn={1}cosine,cn=schema,cn=config`: The Cosine schema
- `cn={2}nis,cn=schema,cn=config`: The Network Information Services (NIS) schema
- `cn={3}inetorgperson,cn=schema,cn=config`: The InetOrgPerson schema
- `olcDatabase={-1}frontend,cn=config`: Frontend database, default settings for other databases
- `olcDatabase={0}config,cn=config`: `slaped` configuration database (*cn=config*)
- `olcDatabase={1}mdb,cn=config`: Your database instance (*dc=example,dc=com*)

- This is what the `dc=example,dc=com` DIT looks like:

```
$ ldapsearch -x -LLL -H ldap:/// -b dc=example,dc=com dn
```

```
dn: dc=example,dc=com
```

```
dn: cn=admin,dc=example,dc=com
```

Explanation of entries:

- `dc=example,dc=com`: Base of the DIT
- `cn=admin,dc=example,dc=com`: Administrator (rootDN) for this DIT (set up during package install)

Notice how we used two different authentication mechanisms:

- `-x`  
This is called a *simple bind*, and is essentially a plain text authentication. Since no *Bind DN* was provided (via `-D`), this became an *anonymous* bind. Without `-x`, the default is to use a Simple Authentication Security Layer (SASL) bind.
- `-Y EXTERNAL`  
This is using a SASL bind (no `-x` was provided), and further specifying the `EXTERNAL` type. Together with `-H ldapi:///`, this uses a local Unix socket connection.

In both cases we only got the results that the server access-control lists (ACLs) allowed us to see, based on who we are. A very handy tool to verify the authentication is `ldapwhoami`, which can be used as follows:

```
$ ldapwhoami -x
anonymous
```

```
$ ldapwhoami -x -D cn=admin,dc=example,dc=com -W
Enter LDAP Password:
dn:cn=admin,dc=example,dc=com
```

When you use simple bind (`-x`) and specify a Bind DN with `-D` as your authentication DN, the server will look for a `userPassword` attribute in the entry, and use that to verify the credentials. In this particular case above, we used the database *Root DN* entry, i.e., the actual administrator, and that is a special case whose password is set in the configuration when the package is installed.

**Note:**

A simple bind without some sort of transport security mechanism is *clear text*, meaning the credentials are transmitted in the clear. You should **add Transport Layer Security (TLS) support** to your OpenLDAP server as soon as possible.

Here are the SASL EXTERNAL examples:

```
$ ldapwhoami -Y EXTERNAL -H ldapi:/// -Q
dn:gidNumber=1000+uidNumber=1000,cn=peercred,cn=external,cn=auth
```

```
$ sudo ldapwhoami -Y EXTERNAL -H ldapi:/// -Q
dn:gidNumber=0+uidNumber=0,cn=peercred,cn=external,cn=auth
```

When using SASL EXTERNAL via the `ldapi:///` transport, the Bind DN becomes a combination of the `uid` and `gid` of the connecting user, followed by the suffix `cn=peercred,cn=external,cn=auth`. The server ACLs know about this, and grant the local root user complete write access to `cn=config` via the SASL mechanism.

## Populating the directory

Let's introduce some content to our directory. We will add the following:

- A node called *People* (to store users)
- A node called *Groups* (to store groups)
- A group called *miners*
- A user called *john*

Create the following LDIF file and call it `add_content.ldif`:

```
dn: ou=People,dc=example,dc=com
objectClass: organizationalUnit
ou: People
```

```
dn: ou=Groups,dc=example,dc=com
objectClass: organizationalUnit
ou: Groups
```

```
dn: cn=miners,ou=Groups,dc=example,dc=com
objectClass: posixGroup
cn: miners
gidNumber: 5000
```

```
dn: uid=john,ou=People,dc=example,dc=com
objectClass: inetOrgPerson
objectClass: posixAccount
objectClass: shadowAccount
uid: john
sn: Doe
givenName: John
cn: John Doe
displayName: John Doe
uidNumber: 10000
```

```
gidNumber: 5000
userPassword: {CRYPT}x
gecos: John Doe
loginShell: /bin/bash
homeDirectory: /home/john
```

**Note:**

It's important that `uid` and `gid` values in your directory do not collide with local values. You can use high number ranges, such as starting at 5000 or even higher.

Add the content:

```
$ ldapadd -x -D cn=admin,dc=example,dc=com -W -f add_content.ldif
Enter LDAP Password: *****
adding new entry "ou=People,dc=example,dc=com"

adding new entry "ou=Groups,dc=example,dc=com"

adding new entry "cn=miners,ou=Groups,dc=example,dc=com"

adding new entry "uid=john,ou=People,dc=example,dc=com"
```

We can check that the information has been correctly added with the `ldapsearch` utility. For example, let's search for the `john` entry, and request the `cn` and `gidnumber` attributes:

```
$ ldapsearch -x -LLL -b dc=example,dc=com '(uid=john)' cn gidNumber
dn: uid=john,ou=People,dc=example,dc=com
cn: John Doe
gidNumber: 5000
```

Here we used an LDAP “filter”: `(uid=john)`. LDAP filters are very flexible and can become complex. For example, to list the group names of which `john` is a member, we could use the filter:

```
(&(objectClass=posixGroup)(memberUid=john))
```

That is a logical *AND* between two attributes. Filters are very important in LDAP and mastering their syntax is extremely helpful. They are used for simple queries like this, but can also select what content is to be replicated to a secondary server, or even in complex ACLs. The full specification is defined in [RFC 4515](#).

Notice we set the `userPassword` field for the `john` entry to the cryptic value `{CRYPT}x`. This essentially is an invalid password, because no hashing will produce just `x`. It's a common pattern when adding a user entry without a default password. To change the password to something valid, you can now use `ldappasswd`:

```
$ ldappasswd -x -D cn=admin,dc=example,dc=com -W -S uid=john,ou=people,dc=example,dc=com
New password:
Re-enter new password:
Enter LDAP Password:
```

**Note:**

Remember that simple binds are insecure and you should **add TLS support** to your server as soon as possible!

## Changing the configuration

The `slapd-config` DIT can also be queried and modified. Here are some common operations.

### Adding an index

Use `ldapmodify` to add an “Index” to your `{1}mdb,cn=config` database definition (for `dc=example,dc=com`). Create a file called `uid_index.ldif`, and add the following contents:

```
dn: olcDatabase={1}mdb,cn=config
add: olcDbIndex
olcDbIndex: mail eq,sub
```

Then issue the command:

```
$ sudo ldapmodify -Q -Y EXTERNAL -H ldapi:/// -f uid_index.ldif

modifying entry "olcDatabase={1}mdb,cn=config"
```

You can confirm the change in this way:

```
$ sudo ldapsearch -Q -LLL -Y EXTERNAL -H ldapi:/// -b \
cn=config '(olcDatabase={1}mdb)' olcDbIndex
```

```
dn: olcDatabase={1}mdb,cn=config
olcDbIndex: objectClass eq
olcDbIndex: cn,uid eq
olcDbIndex: uidNumber,gidNumber eq
olcDbIndex: member,memberUid eq
olcDbIndex: mail eq,sub
```

### Change the RootDN password:

First, run `slappasswd` to get the hash for the new password you want:

```
$ slappasswd
New password:
Re-enter new password:
{SSHA}VKrYMxLSKhONGRpC6rnASKNmXG2xHXFo
```

Now prepare a `changerootpw.ldif` file with this content:

```
dn: olcDatabase={1}mdb,cn=config
changetype: modify
replace: olcRootPW
olcRootPW: {SSHA}VKrYMxLSKhONGRpC6rnASKNmXG2xHXFo
```

Finally, run the `ldapmodify` command:

```
$ sudo ldapmodify -Q -Y EXTERNAL -H ldapi:/// -f changerootpw.ldif
```

```
modifying entry "olcDatabase={1}mdb,cn=config"
```

We still have the actual `cn=admin,dc=example,dc=com` DN in the `dc=example,dc=com` database, so let's change that too. Since this is a regular entry in this database suffix, we can use `ldappasswd`:

```
$ ldappasswd -x -D cn=admin,dc=example,dc=com -W -S
New password:
Re-enter new password:
Enter LDAP Password: <-- current password, about to be changed
```

### Adding a schema

Schemas can only be added to `cn=config` if they are in LDIF format. If not, they will first have to be converted. You can find unconverted schemas in addition to converted ones in the `/etc/ldap/schema` directory.

#### Note:

It is not trivial to remove a schema from the `slapd-config` database. Practice adding schemas on a test system.

In the following example we'll add one of the pre-installed policy schemas in `/etc/ldap/schema/`. The pre-installed schemas exists in both converted (`.ldif`) and native (`.schema`) formats, so we don't have to convert them and can use `ldapadd` directly:

```
$ sudo ldapadd -Q -Y EXTERNAL -H ldapi:/// -f /etc/ldap/schema/corba.ldif
adding new entry "cn=corba,cn=schema,cn=config"
```

If the schema you want to add does not exist in LDIF format, a nice conversion tool that can be used is provided in the `schema2ldif` package.

### Logging

Activity logging for `slapd` is very useful when implementing an OpenLDAP-based solution – yet it must be manually enabled after software installation. Otherwise, only rudimentary messages will appear in the logs. Logging, like any other such configuration, is enabled via the `slapd-config` database.

OpenLDAP comes with multiple logging levels with each one containing the lower one (additive). A good level to try is `stats`. The [slapd-config man page](#) has more to say on the different subsystems.

Create the file `logging.ldif` with the following contents:



```
dn: cn=config
changetype: modify
replace: olcLogLevel
olcLogLevel: stats
```

Implement the change:

```
sudo ldapmodify -Q -Y EXTERNAL -H ldapi:/// -f logging.ldif
```

This will produce a significant amount of logging and you will want to revert back to a less verbose level once your system is in production. While in this verbose mode your host's syslog engine (rsyslog) may have a hard time keeping up and may drop messages:

```
rsyslogd-2177: imuxsock lost 228 messages from pid 2547 due to rate-limiting
```

You may consider a change to rsyslog's configuration. In `/etc/rsyslog.conf`, put:

```
Disable rate limiting
(default is 200 messages in 5 seconds; below we make the 5 become 0)
$SystemLogRateLimitInterval 0
```

And then restart the rsyslog daemon:

```
sudo systemctl restart syslog.service
```

The management of what type of access (read, write, etc) users should be granted for resources is known as *access control*. The configuration directives involved are called *access control lists* or ACLs.

When we installed the `slapd` package various ACLs were set up automatically. We will look at a few important consequences of those defaults and, in so doing, we'll get an idea of how ACLs work and how they're configured.

To get the effective ACL for an LDAP query we need to look at the ACL entries of the database being queried, as well as those of the special frontend database instance. Note that the ACLs belonging to the frontend database are always appended to the database-specific ACLs, and *the first match 'wins'*.

The following commands will give, respectively, the ACLs of the `mdb` database (`dc=example,dc=com`) and those of the frontend database:

```
$ sudo ldapsearch -Q -LLL -Y EXTERNAL -H ldapi:/// -b \
cn=config '(olcDatabase={1}mdb)' olcAccess
```

```
dn: olcDatabase={1}mdb,cn=config
olcAccess: {0}to attrs=userPassword by self write by anonymous auth by * none
olcAccess: {1}to attrs=shadowLastChange by self write by * read
olcAccess: {2}to * by * read
```

```
$ sudo ldapsearch -Q -LLL -Y EXTERNAL -H ldapi:/// -b \
cn=config '(olcDatabase={-1}frontend)' olcAccess
```

```
dn: olcDatabase={-1}frontend,cn=config
olcAccess: {0}to * by dn.exact=gidNumber=0+uidNumber=0,cn=peercred,cn=external
,cn=auth manage by * break
olcAccess: {1}to dn.exact="" by * read
olcAccess: {2}to dn.base="cn=Subschema" by * read
```

**Note:**

The RootDN always has full rights to its database and does not need to be included in any ACL.

The first two ACLs are crucial:

```
olcAccess: {0}to attrs=userPassword by self write by anonymous auth by * none
olcAccess: {1}to attrs=shadowLastChange by self write by * read
```

This can be represented differently for easier reading:

```
to attrs=userPassword
 by self write
 by anonymous auth
 by * none
```

```
to attrs=shadowLastChange
 by self write
```

```
by * read
```

These ACLs enforce the following:

- Anonymous ‘auth’ access is provided to the *userPassword* attribute so that users can authenticate, or *bind*. Perhaps counter-intuitively, ‘by anonymous auth’ is needed even when anonymous access to the DIT is unwanted, otherwise this would be a chicken-and-egg problem: before authentication, all users are anonymous.
- The ‘by self write’ ACL grants write access to the *userPassword* attribute to users who authenticated as the DN where the attribute lives. In other words, users can update the *userPassword* attribute of their own entries.
- The *userPassword* attribute is otherwise inaccessible by all other users, with the exception of the RootDN, who always has access and doesn’t need to be mentioned explicitly.
- In order for users to change their own password, using `passwd` or other utilities, the user’s own *shadowLastChange* attribute needs to be writable. All other directory users get to read this attribute’s contents.

This DIT can be searched anonymously because of ‘to \* by \* read’ in this ACL, which grants read access to everything else, by anyone (including anonymous):

```
to *
 by * read
```

If this is unwanted then you need to change the ACL. To force authentication during a bind request you can alternatively (or in combination with the modified ACL) use the `olcRequire: authc` directive.

As previously mentioned, there is no administrative account (“RootDN”) created for the *slapd-config* database. There is, however, a SASL identity that is granted full access to it. It represents the localhost’s superuser (`root/sudo`). Here it is:

```
dn.exact=gidNumber=0+uidNumber=0,cn=peercred,cn=external,cn=auth
```

The following command will display the ACLs of the *slapd-config* database:

```
$ sudo ldapsearch -Q -LLL -Y EXTERNAL -H ldapi:/// -b \
cn=config '(olcDatabase={0}config)' olcAccess
```

```
dn: olcDatabase={0}config,cn=config
olcAccess: {0}to * by dn.exact=gidNumber=0+uidNumber=0,cn=peercred,
cn=external,cn=auth manage by * break
```

Since this is a SASL identity we need to use a SASL *mechanism* when invoking the LDAP utility in question – the *EXTERNAL* mechanism (see the previous command for an example). Note that:

- You must use `sudo` to become the root identity in order for the ACL to match.
- The *EXTERNAL* mechanism works via *Interprocess Communication* (IPC, UNIX domain sockets). This means you must use the `ldapi` URI format.

A succinct way to get all the ACLs is like this:

```
$ sudo ldapsearch -Q -LLL -Y EXTERNAL -H ldapi:/// -b \
cn=config '(olcAccess=*)' olcAccess olcSuffix
```

## References

- See the man page for [slapd.access](#).
- [Access control](#) topic in the OpenLDAP administrator’s guide

The LDAP service becomes increasingly important as more networked systems begin to depend on it. In such an environment, it is standard practice to build redundancy (high availability) into LDAP to prevent havoc should the LDAP server become unresponsive. This is done through *LDAP replication*.

Replication is achieved via the Sync replication engine, *syncrepl*. This allows changes to be synchronised using a *Consumer - Provider* model. A detailed description of this replication mechanism can be found in the [OpenLDAP administrator’s guide](#) and in its defining [RFC 4533](#).

There are two ways to use this replication:

- *Standard replication*: Changed entries are sent to the consumer in their entirety. For example, if the *userPassword* attribute of the *uid=john,ou=people,dc=example,dc=com* entry changed, then the whole entry is sent to the consumer.
- *Delta replication*: Only the actual change is sent, instead of the whole entry.

The delta replication sends less data over the network, but is more complex to set up. We will show both in this guide.

**Important:**

You **must** have Transport Layer Security (TLS) enabled already. Please consult the [LDAP with TLS guide](#) for details of how to set this up.

## Provider configuration - replication user

Both replication strategies will need a replication user, as well as updates to the ACLs and limits regarding this user. To create the replication user, save the following contents to a file called `replicator.ldif`:

```
dn: cn=replicator,dc=example,dc=com
objectClass: simpleSecurityObject
objectClass: organizationalRole
cn: replicator
description: Replication user
userPassword: {CRYPT}x
```

Then add it with `ldapadd`:

```
$ ldapadd -x -ZZ -D cn=admin,dc=example,dc=com -W -f replicator.ldif
Enter LDAP Password:
adding new entry "cn=replicator,dc=example,dc=com"
```

Now set a password for it with `ldappasswd`:

```
$ ldappasswd -x -ZZ -D cn=admin,dc=example,dc=com -W -S cn=replicator,dc=example,dc=com
New password:
Re-enter new password:
Enter LDAP Password:
```

The next step is to give this replication user the correct privileges, i.e.:

- Read access to the content that we want replicated
- No search limits on this content

For that we need to update the ACLs on the provider. Since ordering matters, first check what the existing ACLs look like on the `dc=example,dc=com` tree:

```
$ sudo ldapsearch -Q -Y EXTERNAL -H ldapi:/// -LLL -b cn=config '(olcSuffix=dc=example,dc=com)' olcAccess
dn: olcDatabase={1}mdb,cn=config
olcAccess: {0}to attrs=userPassword by self write by anonymous auth by * none
olcAccess: {1}to attrs=shadowLastChange by self write by * read
olcAccess: {2}to * by * read
```

What we need is to insert a new rule before the first one, and also adjust the limits for the replicator user. Prepare the `replicator-acl-limits.ldif` file with this content:

```
dn: olcDatabase={1}mdb,cn=config
changetype: modify
add: olcAccess
olcAccess: {0}to *
 by dn.exact="cn=replicator,dc=example,dc=com" read
 by * break
-
add: olcLimits
olcLimits: dn.exact="cn=replicator,dc=example,dc=com"
 time.soft=unlimited time.hard=unlimited
 size.soft=unlimited size.hard=unlimited
```

And add it to the server:

```
$ sudo ldapmodify -Q -Y EXTERNAL -H ldapi:/// -f replicator-acl-limits.ldif
modifying entry "olcDatabase={1}mdb,cn=config"
```

## Provider configuration - standard replication

The remaining configuration for the provider using standard replication is to add the `syncprov` overlay on top of the `dc=example,dc=com` database.

Create a file called `provider_simple_sync.ldif` with this content:

```

Add indexes to the frontend db.
dn: olcDatabase={1}mdb,cn=config
changetype: modify
add: olcDbIndex
olcDbIndex: entryCSN eq
-
add: olcDbIndex
olcDbIndex: entryUUID eq

#Load the syncprov module.
dn: cn=module{0},cn=config
changetype: modify
add: olcModuleLoad
olcModuleLoad: syncprov

syncrepl Provider for primary db
dn: olcOverlay=syncprov,olcDatabase={1}mdb,cn=config
changetype: add
objectClass: olcOverlayConfig
objectClass: olcSyncProvConfig
olcOverlay: syncprov
olcSpCheckpoint: 100 10
olcSpSessionLog: 100

```

**Customisation warning:**

The LDIF above has some parameters that you should review before deploying in production on your directory. In particular – `olcSpCheckpoint` and `olcSpSessionLog`.

Please see the [slapo-syncprov\(5\) man page](#). In general, `olcSpSessionLog` should be equal to (or preferably larger than) the number of entries in your directory. Also see [ITS #8125](#) for details on an existing bug.

Add the new content:

```
sudo ldapadd -Q -Y EXTERNAL -H ldapi:/// -f provider_simple_sync.ldif
```

The Provider is now configured.

## Consumer configuration - standard replication

Install the software by going through [enable TLS](#).

Create an LDIF file with the following contents and name it `consumer_simple_sync.ldif`:

```

dn: cn=module{0},cn=config
changetype: modify
add: olcModuleLoad
olcModuleLoad: syncprov

dn: olcDatabase={1}mdb,cn=config
changetype: modify
add: olcDbIndex
olcDbIndex: entryUUID eq
-
add: olcSyncrepl
olcSyncrepl: rid=0
 provider=ldap://ldap01.example.com
 bindmethod=simple
 binddn="cn=replicator,dc=example,dc=com" credentials=<secret>
 searchbase="dc=example,dc=com"
 schemachecking=on
 type=refreshAndPersist retry="60 +"
 starttls=critical tls_reqcert=demand
-
add: olcUpdateRef
olcUpdateRef: ldap://ldap01.example.com

```

Ensure the following attributes have the correct values:

- **provider:** Provider server's hostname – `ldap01.example.com` in this example – or IP address. It must match what is presented in the provider's SSL certificate.
- **binddn:** The bind DN for the *replicator* user.
- **credentials:** The password you selected for the replicator user.
- **searchbase:** The database suffix you're using, i.e., content that is to be replicated.
- **olcUpdateRef:** Provider server's hostname or IP address, given to clients if they try to write to this consumer.
- **rid:** Replica ID, a unique 3-digit ID that identifies the replica. Each consumer should have at least one rid.

**Note:**

Note that a successful encrypted connection via *START\_TLS* is being enforced in this configuration, to avoid sending the credentials in the clear across the network. See [LDAP with TLS](#) for details on how to set up OpenLDAP with trusted SSL certificates.

Add the new configuration:

```
sudo ldapadd -Q -Y EXTERNAL -H ldapi:/// -f consumer_simple_sync.ldif
```

Now you're done! The *dc=example,dc=com* tree should now be synchronising.

## Provider configuration - delta replication

The remaining provider configuration for delta replication is:

- Create a new database called *accesslog*
- Add the *syncprov* overlay on top of the *accesslog* and *dc=example,dc=com* databases
- Add the *accesslog* overlay on top of the *dc=example,dc=com* database

### Add syncprov and accesslog overlays and DBs

Create an LDIF file with the following contents and name it *provider\_sync.ldif*:

```
Add indexes to the frontend db.
dn: olcDatabase={1}mdb,cn=config
changetype: modify
add: olcDbIndex
olcDbIndex: entryCSN eq
-
add: olcDbIndex
olcDbIndex: entryUUID eq

#Load the syncprov and accesslog modules.
dn: cn=module{0},cn=config
changetype: modify
add: olcModuleLoad
olcModuleLoad: syncprov
-
add: olcModuleLoad
olcModuleLoad: accesslog

Accesslog database definitions
dn: olcDatabase={2}mdb,cn=config
objectClass: olcDatabaseConfig
objectClass: olcMdbConfig
olcDatabase: {2}mdb
olcDbDirectory: /var/lib/ldap/accesslog
olcSuffix: cn=accesslog
olcRootDN: cn=admin,dc=example,dc=com
olcDbIndex: default eq
olcDbIndex: entryCSN,objectClass,reqEnd,reqResult,reqStart
olcAccess: {0}to * by dn.exact="cn=replicator,dc=example,dc=com" read by * break
olcLimits: dn.exact="cn=replicator,dc=example,dc=com"
 time.soft=unlimited time.hard=unlimited
 size.soft=unlimited size.hard=unlimited
```

```

Accesslog db syncprov.
dn: olcOverlay=syncprov,olcDatabase={2}mdb,cn=config
changetype: add
objectClass: olcOverlayConfig
objectClass: olcSyncProvConfig
olcOverlay: syncprov
olcSpNoPresent: TRUE
olcSpReloadHint: TRUE

syncrepl Provider for primary db
dn: olcOverlay=syncprov,olcDatabase={1}mdb,cn=config
changetype: add
objectClass: olcOverlayConfig
objectClass: olcSyncProvConfig
olcOverlay: syncprov
olcSpCheckpoint: 100 10
olcSpSessionLog: 100

accesslog overlay definitions for primary db
dn: olcOverlay=accesslog,olcDatabase={1}mdb,cn=config
objectClass: olcOverlayConfig
objectClass: olcAccessLogConfig
olcOverlay: accesslog
olcAccessLogDB: cn=accesslog
olcAccessLogOps: writes
olcAccessLogSuccess: TRUE
scan the accesslog DB every day, and purge entries older than 7 days
olcAccessLogPurge: 07+00:00 01+00:00

```

#### Customisation warning:

The LDIF above has some parameters that you should review before deploying in production on your directory. In particular – `olcSpCheckpoint`, `olcSpSessionLog`.

Please see the [slapo-syncprov\(5\) manpage](#). In general, `olcSpSessionLog` should be equal to (or preferably larger than) the number of entries in your directory. Also see [ITS #8125](#) for details on an existing bug.

For `olcAccessLogPurge`, please check the [slapo-accesslog\(5\) manpage](#).

Create a directory:

```
sudo -u openldap mkdir /var/lib/ldap/accesslog
```

Add the new content:

```
sudo ldapadd -Q -Y EXTERNAL -H ldapi:/// -f provider_sync.ldif
```

The Provider is now configured.

## Consumer configuration

Install the software by going through [enable TLS](#).

Create an LDIF file with the following contents and name it `consumer_sync.ldif`:

```

dn: cn=module{0},cn=config
changetype: modify
add: olcModuleLoad
olcModuleLoad: syncprov

dn: olcDatabase={1}mdb,cn=config
changetype: modify
add: olcDbIndex
olcDbIndex: entryUUID eq
-
add: olcSyncrepl
olcSyncrepl: rid=0
 provider=ldap://ldap01.example.com
 bindmethod=simple
 binddn="cn=replicator,dc=example,dc=com" credentials=<secret>

```

```

searchbase="dc=example,dc=com"
logbase="cn=accesslog"
logfilter="(&(objectClass=auditWriteObject)(reqResult=0))"
schemachecking=on
type=refreshAndPersist retry="60 +"
syncdata=accesslog
starttls=critical tls_reqcert=demand
-
add: olcUpdateRef
olcUpdateRef: ldap://ldap01.example.com

```

Ensure the following attributes have the correct values:

- **provider:** Provider server's hostname – `ldap01.example.com` in this example – or IP address. It must match what is presented in the provider's SSL certificate.
- **binddn:** The bind DN for the *replicator* user.
- **credentials:** The password you selected for the replicator user.
- **searchbase:** The database suffix you're using, i.e., content that is to be replicated.
- **olcUpdateRef:** Provider server's hostname or IP address, given to clients if they try to write to this consumer.
- **rid:** Replica ID, a unique 3-digit ID that identifies the replica. Each consumer should have at least one rid.

**Note:**

Note that a successful encrypted connection via *START\_TLS* is being enforced in this configuration, to avoid sending the credentials in the clear across the network. See [LDAP with TLS](#) for details on how to set up OpenLDAP with trusted SSL certificates.

Add the new configuration:

```
sudo ldapadd -Q -Y EXTERNAL -H ldapi:/// -f consumer_sync.ldif
```

You're done! The *dc=example,dc=com* tree should now be synchronising.

## Testing

Once replication starts, you can monitor it by running:

```

$ ldapsearch -z1 -LLL -x -s base -b dc=example,dc=com contextCSN
dn: dc=example,dc=com
contextCSN: 20200423222317.722667Z#000000#000#000000

```

On both the provider and the consumer. Once the *contextCSN* value for both match, both trees are in sync. Every time a change is done in the provider, this value will change and so should the one in the consumer(s).

If your connection is slow and/or your LDAP database large, it might take a while for the consumer's *contextCSN* match the provider's. But, you will know it is progressing since the consumer's *contextCSN* will be steadily increasing.

If the consumer's *contextCSN* is missing or does not match the provider, you should stop and figure out the issue before continuing. Try checking the `slapd` entries in `/var/log/syslog` in the provider to see if the consumer's authentication requests were successful, or that its requests to retrieve data return no errors. In particular, verify that you can connect to the provider from the consumer as the replicator BindDN using *START\_TLS*:

```
ldapwhoami -x -ZZ -D cn=replicator,dc=example,dc=com -W -h ldap01.example.com
```

For our example, you should now see the *john* user in the replicated tree:

```

$ ldapsearch -x -LLL -b dc=example,dc=com -h ldap02.example.com '(uid=john)' uid
dn: uid=john,ou=People,dc=example,dc=com
uid: john

```

## References

- [Replication types, OpenLDAP Administrator's Guide](#)
- [LDAP Sync Replication - OpenLDAP Administrator's Guide](#)
- [RFC 4533](#).

Once you have a working LDAP server, you will need to install libraries on the client that know how and when to contact it. On Ubuntu, this has been traditionally accomplished by installing the `libnss-ldap` package, but nowadays you should use the System Security Services Daemon (SSSD). Please refer to [SSSD and LDAP](#) for more details.

## User and group management - ldapscripts

Another very common usage case for having an LDAP server is to store Unix user and group information in the directory. There are many tools out there, but usually big deployments will have developed their own. Here we will briefly show how to use the `ldapscripts` package for a quick and easy way to start storing user and group information in OpenLDAP.

### Install the package

You can install `ldapscripts` by running the following command:

```
sudo apt install ldapscripts
```

Then edit the file `/etc/ldapscripts/ldapscripts.conf` to arrive at something similar to the following:

```
SERVER=ldap://ldap01.example.com
LDAPBINOPTS="-ZZ"
BINDDN='cn=admin,dc=example,dc=com'
BINDPWDFILE="/etc/ldapscripts/ldapscripts.passwd"
SUFFIX='dc=example,dc=com'
GSUFFIX='ou=Groups'
USUFFIX='ou=People'
MSUFFIX='ou=Computers'
```

#### Note:

- Adjust `SERVER` and related `SUFFIX` options to suit your directory structure.
- Note we are forcing `START_TLS` usage here (`-ZZ` parameter), please refer to [LDAP with TLS](#) for details on how to set up the server with TLS support.

Store the `cn=admin` password in the `/etc/ldapscripts/ldapscripts.passwd` file and make sure it's only readable by the `root` local user:

```
sudo chmod 400 /etc/ldapscripts/ldapscripts.passwd
```

The scripts are now ready to help manage your directory.

## Examples – how to use the scripts

### Create a new user

```
sudo ldapaddgroup george
sudo ldapadduser george george
```

This will create a group and user with name `george` and set the user's primary group (`gid`) to `george`.

### Change a user's password

```
$ sudo ldapsetpasswd george
Changing password for user uid=george,ou=People,dc=example,dc=com
New Password:
Retype New Password:
Successfully set password for user uid=george,ou=People,dc=example,dc=com
```

### Delete a user

```
sudo ldapdeleteuser george
```

Note that this won't delete the user's primary group, but will remove the user from supplementary ones.

### Add a group

```
sudo ldapaddgroup qa
```

### Delete a group

```
sudo ldapdeletegroup qa
```



## Add a user to a group

```
sudo ldapaddusertogroup george qa
```

You should now see a *memberUid* attribute for the *qa* group with a value of *george*.

## Remove a user from a group

```
sudo ldapdeleteuserfromgroup george qa
```

The *memberUid* attribute should now be removed from the *qa* group.

## The ldapmodifyuser script

This script allows you to add, remove, or replace a user's attributes. The script uses the same syntax as the *ldapmodify* utility. For example:

```
sudo ldapmodifyuser george
About to modify the following entry :
dn: uid=george,ou=People,dc=example,dc=com
objectClass: account
objectClass: posixAccount
cn: george
uid: george
uidNumber: 10001
gidNumber: 10001
homeDirectory: /home/george
loginShell: /bin/bash
gecos: george
description: User account
userPassword:: e1NTSEF9eXF5TFcyWlhWkF1eGUybVdFWHZKRzJVMjFTSG9vcHk=

Enter your modifications here, end with CTRL-D.
dn: uid=george,ou=People,dc=example,dc=com
replace: geocos
gecos: George Carlin
```

The user's *gecos* should now be "George Carlin".

## ldapscripts templates

A nice feature of *ldapscripts* is the template system. Templates allow you to customise the attributes of user, group, and machine objects. For example, to enable the *user* template, edit */etc/ldapscripts/ldapscripts.conf* by changing:

```
UTEMPLATE="/etc/ldapscripts/ldapadduser.template"
```

There are sample templates in the */usr/share/doc/ldapscripts/examples* directory. Copy or rename the *ldapadduser.template.sample* file to */etc/ldapscripts/ldapadduser.template*:

```
sudo cp /usr/share/doc/ldapscripts/examples/ldapadduser.template.sample \
/etc/ldapscripts/ldapadduser.template
```

Edit the new template to add the desired attributes. The following will create new users with an *objectClass* of *inetOrgPerson*:

```
dn: uid=<user>,<usuffix>,<suffix>
objectClass: inetOrgPerson
objectClass: posixAccount
cn: <user>
sn: <ask>
uid: <user>
uidNumber: <uid>
gidNumber: <gid>
homeDirectory: <home>
loginShell: <shell>
gecos: <user>
description: User account
title: Employee
```

Notice the `<ask>` option used for the `sn` attribute. This will make `ldapadduser` prompt you for its value.

There are utilities in the package that were not covered here. This command will output a list of them:

```
dpkg -L ldapscripts | grep /usr/sbin
```

When authenticating to an OpenLDAP server it is best to do so using an encrypted session. This can be accomplished using Transport Layer Security (TLS).

Here, we will be our own *Certificate Authority* (CA) and then create and sign our LDAP server certificate as that CA. This guide will use the `certtool` utility to complete these tasks. For simplicity, this is being done on the OpenLDAP server itself, but your real internal CA should be elsewhere.

Install the `gnutls-bin` and `ssl-cert` packages:

```
sudo apt install gnutls-bin ssl-cert
```

Create a private key for the Certificate Authority:

```
sudo certtool --generate-privkey --bits 4096 --outfile /etc/ssl/private/mycakey.pem
```

Create the template/file `/etc/ssl/ca.info` to define the CA:

```
cn = Example Company
ca
cert_signing_key
expiration_days = 3650
```

Create the self-signed CA certificate:

```
sudo certtool --generate-self-signed \
--load-privkey /etc/ssl/private/mycakey.pem \
--template /etc/ssl/ca.info \
--outfile /usr/local/share/ca-certificates/mycacert.crt
```

**Note:**

Yes, the `--outfile` path is correct. We are writing the CA certificate to `/usr/local/share/ca-certificates`. This is where `update-ca-certificates` will pick up trusted local CAs from. To pick up CAs from `/usr/share/ca-certificates`, a call to `dpkg-reconfigure ca-certificates` is necessary.

Run `update-ca-certificates` to add the new CA certificate to the list of trusted CAs. Note the one added CA:

```
$ sudo update-ca-certificates
Updating certificates in /etc/ssl/certs...
1 added, 0 removed; done.
Running hooks in /etc/ca-certificates/update.d...
done.
```

This also creates a `/etc/ssl/certs/mycacert.pem` symlink pointing to the real file in `/usr/local/share/ca-certificates`.

Make a private key for the server:

```
sudo certtool --generate-privkey \
--bits 2048 \
--outfile /etc/ldap/ldap01_slapd_key.pem
```

**Note:**

Replace `ldap01` in the filename with your server's hostname. Naming the certificate and key for the host and service that will be using them will help keep things clear.

Create the `/etc/ssl/ldap01.info` info file containing:

```
organization = Example Company
cn = ldap01.example.com
tls_www_server
encryption_key
signing_key
expiration_days = 365
```

The above certificate is good for 1 year, and it's valid only for the `ldap01.example.com` hostname. You can adjust this according to your needs.

Create the server's certificate:

```
sudo certtool --generate-certificate \
--load-privkey /etc/ldap/ldap01_slapd_key.pem \
--load-ca-certificate /etc/ssl/certs/mycacert.pem \
--load-ca-privkey /etc/ssl/private/mycakey.pem \
--template /etc/ssl/ldap01.info \
--outfile /etc/ldap/ldap01_slapd_cert.pem
```

Adjust permissions and ownership:

```
sudo chgrp openldap /etc/ldap/ldap01_slapd_key.pem
sudo chmod 0640 /etc/ldap/ldap01_slapd_key.pem
```

Your server is now ready to accept the new TLS configuration.

Create the file `certinfo.ldif` with the following contents (adjust paths and filenames accordingly):

```
dn: cn=config
add: olcTLSCACertificateFile
olcTLSCACertificateFile: /etc/ssl/certs/mycacert.pem
-
add: olcTLSCertificateFile
olcTLSCertificateFile: /etc/ldap/ldap01_slapd_cert.pem
-
add: olcTLSCertificateKeyFile
olcTLSCertificateKeyFile: /etc/ldap/ldap01_slapd_key.pem
```

Use the `ldapmodify` command to tell `slapd` about our TLS work via the `slapd-config` database:

```
sudo ldapmodify -Y EXTERNAL -H ldapi:/// -f certinfo.ldif
```

If you need access to *LDAPS* (LDAP over SSL), then you need to edit `/etc/default/slapd` and include `ldaps:///` in `SLAPD_SERVICES` like below:

```
SLAPD_SERVICES="ldap:/// ldapi:/// ldaps:///"
```

And restart `slapd` with: `sudo systemctl restart slapd`.

Note that *StartTLS* will be available without the change above, and does NOT need a `slapd` restart.

Test *StartTLS*:

```
$ ldapwhoami -x -ZZ -H ldap://ldap01.example.com
anonymous
```

Test *LDAPS*:

```
$ ldapwhoami -x -H ldaps://ldap01.example.com
anonymous
```

## Certificate for an OpenLDAP replica

To generate a certificate pair for an OpenLDAP replica (consumer), create a holding directory (which will be used for the eventual transfer) and run the following:

```
mkdir ldap02-ssl
cd ldap02-ssl
certtool --generate-privkey \
--bits 2048 \
--outfile ldap02_slapd_key.pem
```

Create an info file, `ldap02.info`, for the Consumer server, adjusting its values according to your requirements:

```
organization = Example Company
cn = ldap02.example.com
tls_www_server
encryption_key
signing_key
expiration_days = 365
```

Create the Consumer's certificate:

```
sudo certtool --generate-certificate \
--load-privkey ldap02_slapd_key.pem \
```

```
--load-ca-certificate /etc/ssl/certs/mycacert.pem \
--load-ca-privkey /etc/ssl/private/mycakey.pem \
--template ldap02.info \
--outfile ldap02_slapd_cert.pem
```

**Note:**

We had to use `sudo` to get access to the CA's private key. This means the generated certificate file is owned by root. You should change that ownership back to your regular user before copying these files over to the Consumer.

Get a copy of the CA certificate:

```
cp /etc/ssl/certs/mycacert.pem .
```

We're done. Now transfer the `ldap02-ssl` directory to the Consumer. Here we use `scp` (adjust accordingly):

```
cd ..
scp -r ldap02-ssl user@consumer:
```

On the Consumer side, install the certificate files you just transferred:

```
sudo cp ldap02_slapd_cert.pem ldap02_slapd_key.pem /etc/ldap
sudo chgrp openldap /etc/ldap/ldap02_slapd_key.pem
sudo chmod 0640 /etc/ldap/ldap02_slapd_key.pem
sudo cp mycacert.pem /usr/local/share/ca-certificates/mycacert.crt
sudo update-ca-certificates
```

Create the file `certinfo.ldif` with the following contents (adjust accordingly regarding paths and filenames, if needed):

```
dn: cn=config
add: olcTLSCACertificateFile
olcTLSCACertificateFile: /etc/ssl/certs/mycacert.pem
-
add: olcTLSCertificateFile
olcTLSCertificateFile: /etc/ldap/ldap02_slapd_cert.pem
-
add: olcTLSCertificateKeyFile
olcTLSCertificateKeyFile: /etc/ldap/ldap02_slapd_key.pem
```

Configure the `slapd-config` database:

```
sudo ldapmodify -Y EXTERNAL -H ldapi:/// -f certinfo.ldif
```

Like before, if you want to enable `LDAPS`, edit `/etc/default/slapd` and add `ldaps:///` to `SLAPD_SERVICES`, and then restart `slapd`.

Test *StartTLS*:

```
$ ldapwhoami -x -ZZ -H ldap://ldap02.example.com
anonymous
```

Test *LDAPS*:

```
$ ldapwhoami -x -H ldaps://ldap02.example.com
anonymous
```

Now we have LDAP running just the way we want, it is time to ensure we can save all of our work and restore it as needed.

What we need is a way to back up the directory database(s) – specifically the configuration backend (`cn=config`) and the DIT (`dc=example,dc=com`). If we are going to backup those databases into, say, `/export/backup`, we could use `slapcat` as shown in the following script, called `/usr/local/bin/ldapbackup`:

```
#!/bin/bash

set -e

BACKUP_PATH=/export/backup
SLAPCAT=/usr/sbin/slapcat

nice ${SLAPCAT} -b cn=config > ${BACKUP_PATH}/config.ldif
nice ${SLAPCAT} -b dc=example,dc=com > ${BACKUP_PATH}/example.com.ldif
```

```
chown root:root ${BACKUP_PATH}/*
chmod 600 ${BACKUP_PATH}/*.ldif
```

**Note:**

These files are uncompressed text files containing everything in your directory including the tree layout, usernames, and every password. So, you might want to consider making `/export/backup` an encrypted partition and even having the script encrypt those files as it creates them. Ideally you should do both, but that depends on your security requirements.

Then, it is just a matter of having a cron script to run this program as often as you feel comfortable with. For many, once a day suffices. For others, more often is required. Here is an example of a cron script called `/etc/cron.d/ldapbackup` that is run every night at 22:45h:

```
MAILTO=backup-emails@domain.com
45 22 * * * root /usr/local/bin/ldapbackup
```

Now the files are created, they should be copied to a backup server.

Assuming we did a fresh reinstall of LDAP, the restore process could be something like this:

```
#!/bin/bash

set -e

BACKUP_PATH=/export/backup
SLAPADD=/usr/sbin/slapadd

if [-n "$(ls -l /var/lib/ldap/* 2>/dev/null)" -o -n "$(ls -l /etc/ldap/slapd.d/* 2>/dev/null)"]; then
 echo Run the following to remove the existing db:
 echo sudo systemctl stop slapd.service
 echo sudo rm -rf /etc/ldap/slapd.d/* /var/lib/ldap/*
 exit 1
fi

sudo systemctl stop slapd.service || :
sudo slapadd -F /etc/ldap/slapd.d -b cn=config -l /export/backup/config.ldif
sudo slapadd -F /etc/ldap/slapd.d -b dc=example,dc=com -l /export/backup/example.com.ldif
sudo chown -R openldap:openldap /etc/ldap/slapd.d/
sudo chown -R openldap:openldap /var/lib/ldap/
sudo systemctl start slapd.service
```

This is a simplistic backup strategy, of course. It's being shown here as a reference for the basic tooling you can use for backups and restores.

A Samba server needs to join the Active Directory (AD) domain before it can serve files and printers to Active Directory users. This is different from [Network User Authentication with SSSD](#), where we integrate the AD users and groups into the local Ubuntu system as if they were local.

For Samba to authenticate these users via Server Message Block (SMB) authentication protocols, we need both for the remote users to be “seen”, and for Samba itself to be aware of the domain. In this scenario, Samba is called a Member Server or Domain Member.

**See also:**

Samba itself has the necessary tooling to join an Active Directory domain. It requires a sequence of manual steps and configuration file editing, which is [thoroughly documented on the Samba wiki](#). It's useful to read that documentation to get an idea of the steps necessary, and the decisions you will need to make.

## Use `realmd` to join the Active Directory domain

For this guide, though, we are going to use the `realmd` package and instruct it to use the Samba tooling for joining the AD domain. This package will make certain decisions for us which will work for most cases, but more complex setups involving multiple or very large domains might require additional tweaking.

### Install `realmd`

First, let's install the necessary packages:

```
sudo apt install realmd samba
```

In order to have the joined machine registered in the AD DNS, it needs to have an FQDN set. You might have that already, if running the `hostname -f` command returns a full hostname with domain. If it doesn't, then set the hostname as follows:

```
sudo hostnamectl hostname <yourfqdn>
```

For this guide, we will be using `j1.internal.example.fake`, and the AD domain will be `internal.example.fake`.

## Verify the AD server

Next, we need to verify that the AD server is both reachable and known by running the following command:

```
sudo realm discover internal.example.fake
```

This should provide an output like this, given our setup:

```
internal.example.fake
 type: kerberos
 realm-name: INTERNAL.EXAMPLE.FAKE
 domain-name: internal.example.fake
 configured: no
 server-software: active-directory
 client-software: sssd
 required-package: sssd-tools
 required-package: sssd
 required-package: libnss-sss
 required-package: libpam-sss
 required-package: adcli
 required-package: samba-common-bin
```

`realm` is suggesting a set of packages for the discovered domain, but we will override that and select the Samba tooling for this join, because we want Samba to become a Member Server.

## Join the AD domain

Let's join the domain in verbose mode so we can see all the steps:

```
sudo realm join -v --membership-software=samba --client-software=winbind internal.example.fake
```

This should produce the following output for us:

```
* Resolving: _ldap._tcp.internal.example.fake
* Performing LDAP DSE lookup on: 10.0.16.5
* Successfully discovered: internal.example.fake
Password for Administrator:
* Unconditionally checking packages
* Resolving required packages
* Installing necessary packages: libnss-winbind samba-common-bin libpam-winbind winbind
* LANG=C LOGNAME=root /usr/bin/net --configfile /var/cache/realmd/realmd-smb-conf.A53N01 -U Administrator -
-use-kerberos=required ads join internal.example.fake
Password for [INTEEXAMPLE\Administrator]:
Using short domain name -- INTEEXAMPLE
Joined 'J1' to dns domain 'internal.example.fake'
* LANG=C LOGNAME=root /usr/bin/net --configfile /var/cache/realmd/realmd-smb-conf.A53N01 -U Administrator ads keytab cre
Password for [INTEEXAMPLE\Administrator]:
* /usr/sbin/update-rc.d winbind enable
* /usr/sbin/service winbind restart
* Successfully enrolled machine in realm
```

### Note:

This command also installed the `libpam-winbind` package, **which allows AD users to authenticate to other services on this system via PAM, like SSH or console logins**. For example, if your SSH server allows password authentication (`PasswordAuthentication yes` in `/etc/ssh/sshd_config`), then the domain users will be allowed to login remotely on this system via SSH.

If you don't expect or need AD users to log into this system (unless it's via Samba or Windows), then it's safe and probably best to remove the `libpam-winbind` package.

Until [bug #1980246](#) is fixed, one extra step is needed:

- Configure `/etc/nsswitch.conf` by adding the word `winbind` to the `passwd` and `group` lines as shown below:

```
passwd: files systemd winbind
group: files systemd winbind
```

Now you will be able to query users from the AD domain. Winbind adds the short domain name as a prefix to domain users and groups:

```
$ getent passwd INTEXAMPLE\Administrator
INTEXAMPLE\administrator:*:2000500:2000513::/home/administrator@INTEXAMPLE:/bin/bash
```

You can find out the short domain name in the `realm` output shown earlier, or inspect the `workgroup` parameter of `/etc/samba/smb.conf`.

## Common installation options

When domain users and groups are brought to the Linux world, a bit of translation needs to happen, and sometimes new values need to be created. For example, there is no concept of a “login shell” for AD users, but it exists in Linux.

The following are some common `/etc/samba/smb.conf` options you are likely to want to tweak in your installation. The [smb.conf\(5\) man page](#) explains the % variable substitutions and other details:

- **home directory**  
template homedir = /home/%U@%D  
(Another popular choice is /home/%D/%U)
- **login shell**  
template shell = /bin/bash
- **winbind separator = \**  
This is the \ character between the short domain name and the user or group name that we saw in the `getent passwd` output above.
- **winbind use default domain**  
If this is set to `yes`, then the domain name will not be part of the users and groups. Setting this to `yes` makes the system more friendly towards Linux users, as they won’t have to remember to include the domain name every time a user or group is referenced. However, if multiple domains are involved, such as in an AD forest or other form of domain trust relationship, then leave this setting at `no` (default).

To have the home directory created automatically the first time a user logs in to the system, and if you haven’t removed `libpam-winbind`, then enable the `pam_mkhome` module via this command:

```
sudo pam-auth-update --enable mkhome
```

Note that this won’t apply to logins via Samba: this only creates the home directory for system logins like those via `ssh` or the console.

## Export shares

Shares can be exported as usual. Since this is now a Member Server, there is no need to deal with user and group management. All of this is integrated with the Active Directory server we joined.

For example, let’s create a simple `[storage]` share. Add this to the `/etc/samba/smb.conf` file:

```
[storage]
 path = /storage
 comment = Storage share
 writable = yes
 guest ok = no
```

Then create the `/storage` directory. Let’s also make it `1777` so all users can use it, and then ask `samba` to reload its configuration:

```
sudo mkdir -m 1777 /storage
sudo smbcontrol smbd reload-config
```

With this, users from the AD domain will be able to access this share. For example, if there is a user `ubuntu` the following command would access the share from another system, using the domain credentials:

```
$ smbclient //j1.internal.example.fake/storage -U INTEXAMPLE\ubuntu
Enter INTEXAMPLE\ubuntu's password:
Try "help" to get a list of possible commands.
smb: \>
```

And `smbstatus` on the member server will show the connected user:

```
$ sudo smbstatus
```

```
Samba version 4.15.5-Ubuntu
```

```
PID Username Group Machine Protocol Version Encryption Signing

3631 INTEXAMPLE\ubuntu INTEXAMPLE\domain users 10.0.16.1 (ipv4:10.0.16.1:39534) SMB3_11 -
partial(AES-128-CMAC)
```

```
Service pid Machine Connected at Encryption Signing

storage 3631 10.0.16.1 Wed Jun 29 17:42:54 2022 UTC - -
```

```
No locked files
```

You can also restrict access to the share as usual. Just keep in mind the syntax for the domain users. For example, to restrict access to the [storage] share we just created to *only* members of the LTS Releases domain group, add the `valid users` parameter like below:

```
[storage]
 path = /storage
 comment = Storage share
 writable = yes
 guest ok = no
 valid users = "@INTEXAMPLE\LTS Releases"
```

## Choose an idmap backend

`realm` made some choices for us when we joined the domain. A very important one is the `idmap` backend, and it might need changing for more complex setups.

User and group identifiers on the AD side are not directly usable as identifiers on the Linux site. A *mapping* needs to be performed.

Winbind supports several `idmap` backends, and each one has its own man page. The three main ones are:

- `idmap_ad`
- `idmap_automid`
- `idmap_rid`

Choosing the correct backend for each deployment type needs careful planning. Upstream has some guidelines at [Choosing an idmap backend](#), and each man page has more details and recommendations.

The `realm` tool selects (by default) the `rid` backend. This backend uses an algorithm to calculate the Unix user and group IDs from the respective RID value on the AD side. You might need to review the `idmap config` settings in `/etc/samba/smb.conf` and make sure they can accommodate the number of users and groups that exist in the domain, and that the range does not overlap with users from other sources.

For example, these settings:

```
idmap config * : range = 10000-999999
idmap config intexample : backend = rid
idmap config intexample : range = 2000000-2999999
idmap config * : backend = tdb
```

Will reserve the 2,000,000 through 2,999,999 range for user and group ID allocations on the Linux side for the `intexample` domain. The default backend (`*`, which acts as a “globbing” catch-all rule) is used for the `BUILTIN` user and groups, and other domains (if they exist). It’s important that these ranges do not overlap.

The `Administrator` user we inspected before with `getent passwd` can give us a glimpse of how these ranges are used (output format changed for clarity):

```
$ id INTEXAMPLE\Administrator
uid=2000500(INTEXAMPLE administrator)
gid=2000513(INTEXAMPLE domain users)
groups=2000513(INTEXAMPLE domain users),
 2000500(INTEXAMPLE administrator),
 2000572(INTEXAMPLE denied rodc password replication group),
 2000519(INTEXAMPLE enterprise admins),
```



```
2000518(INTEXAMPLE\schemata admins),
2000520(INTEXAMPLE\group policy creator owners),
2000512(INTEXAMPLE\domain admins),
10001(BUILTIN\users),
10000(BUILTIN\administrators)
```

## Further reading

- [The Samba Wiki](#)

One of the most common ways to network Ubuntu and Windows computers is to configure Samba as a *file server*. It can be set up to share files with Windows clients, as we'll see in this section.

The server will be configured to share files with any client on the network without prompting for a password. If your environment requires stricter Access Controls see [Share Access Control](#).

## Install Samba

The first step is to install the `samba` package. From a terminal prompt enter:

```
sudo apt install samba
```

That's all there is to it; you are now ready to configure Samba to share files.

## Configure Samba as a file server

The main Samba configuration file is located in `/etc/samba/smb.conf`. The default configuration file contains a significant number of comments, which document various configuration directives.

### Note:

Not all available options are included in the default configuration file. See the [smb.conf man page](#) or the [Samba HOWTO Collection](#) for more details.

First, edit the `workgroup` parameter in the *[global]* section of `/etc/samba/smb.conf` and change it to better match your environment:

```
workgroup = EXAMPLE
```

Create a new section at the bottom of the file, or uncomment one of the examples, for the directory you want to share:

```
[share]
comment = Ubuntu File Server Share
path = /srv/samba/share
browsable = yes
guest ok = yes
read only = no
create mask = 0755
```

- **comment**  
A short description of the share. Adjust to fit your needs.
- **path**  
The path to the directory you want to share.

### Note:

This example uses `/srv/samba/sharename` because, according to the *Filesystem Hierarchy Standard (FHS)*, `/srv` is where site-specific data should be served. Technically, Samba shares can be placed anywhere on the filesystem as long as the permissions are correct, but adhering to standards is recommended.

- **browsable**  
Enables Windows clients to browse the shared directory using Windows Explorer.
- **guest ok**  
Allows clients to connect to the share without supplying a password.
- *read only*: determines if the share is read only or if write privileges are granted. Write privileges are allowed only when the value is *no*, as is seen in this example. If the value is *yes*, then access to the share is read only.
- **create mask**  
Determines the permissions that new files will have when created.

## Create the directory

Now that Samba is configured, the directory needs to be created and the permissions changed. From a terminal, run the following commands:

```
sudo mkdir -p /srv/samba/share
sudo chown nobody:nogroup /srv/samba/share/
```

The `-p` switch tells `mkdir` to create the entire directory tree if it doesn't already exist.

## Enable the new configuration

Finally, restart the Samba services to enable the new configuration by running the following command:

```
sudo systemctl restart smb.service nmbd.service
```

### Warning:

Once again, the above configuration gives full access to any client on the local network. For a more secure configuration see [Share Access Control](#).

From a Windows client you should now be able to browse to the Ubuntu file server and see the shared directory. If your client doesn't show your share automatically, try to access your server by its IP address, e.g. `\\192.168.1.1`, in a Windows Explorer window. To check that everything is working try creating a directory from Windows.

To create additional shares simply create new `[sharename]` sections in `/etc/samba/smb.conf`, and restart *Samba*. Just make sure that the directory you want to share actually exists and the permissions are correct.

The file share named `[share]` and the path `/srv/samba/share` used in this example can be adjusted to fit your environment. It is a good idea to name a share after a directory on the file system. Another example would be a share name of `[qa]` with a path of `/srv/samba/qa`.

## Further reading

- For in-depth Samba configurations see the [Samba HOWTO Collection](#)
- The guide is also available [in printed format](#).
- O'Reilly's [Using Samba](#) is another good reference.
- The [Ubuntu Wiki Samba](#) page.

Another common way to network Ubuntu and Windows computers is to configure Samba as a *print server*. This will allow it to share printers installed on an Ubuntu server, whether locally or over the network.

Just as we did in [using Samba as a file server](#), this section will configure Samba to allow any client on the local network to use the installed printers without prompting for a username and password.

If your environment requires stricter Access Controls see [Share Access Control](#).

## Install and configure CUPS

Before installing and configuring Samba as a print server, it is best to already have a working CUPS installation. See [our guide on CUPS](#) for details.

## Install Samba

To install the `samba` package, run the following command in your terminal:

```
sudo apt install samba
```

## Configure Samba

After installing `samba`, edit `/etc/samba/smb.conf`. Change the *workgroup* attribute to what is appropriate for your network:

```
workgroup = EXAMPLE
```

In the `[printers]` section, change the *guest ok* option to 'yes':

```
browsable = yes
guest ok = yes
```

After editing `smb.conf`, restart Samba:

```
sudo systemctl restart smb.service nmbd.service
```

The default Samba configuration will automatically share any printers installed. Now all you need to do is install the printer locally on your Windows clients.

## Further reading

- For in-depth Samba configurations see the [Samba HOWTO Collection](#).
- The guide is also available in [printed format](#).
- O'Reilly's [Using Samba](#) is another good reference.
- Also, see the [CUPS Website](#) for more information on configuring CUPS.
- The [Ubuntu Wiki Samba](#) page.

There are several options available to control access for each individual shared directory. Using the *[share]* example, this section will cover some common options.

## Groups

*Groups* define a collection of users who have a common level of access to particular network resources. This provides granularity in controlling access to such resources. For example, let's consider a group called "qa" is defined to contain the users *Freda*, *Danika*, and *Rob*, and then a group called "support" is created containing the users *Danika*, *Jeremy*, and *Vincent*. Any network resources configured to allow access by the "qa" group will be available to Freda, Danika, and Rob, but not Jeremy or Vincent. Danika can access resources available to both groups since she belongs to both the "qa" and "support" groups. All other users only have access to resources explicitly allowed to the group they are part of.

When mentioning groups in the Samba configuration file, */etc/samba/smb.conf*, the recognized syntax is to preface the group name with an "@" symbol. For example, if you wished to use a group named *sysadmin* in a certain section of the */etc/samba/smb.conf*, you would do so by entering the group name as *@sysadmin*. If a group name has a space in it, use double quotes, like "*@LTS Releases*".

## Read and write permissions

Read and write permissions define the explicit rights a computer or user has to a particular share. Such permissions may be defined by editing the */etc/samba/smb.conf* file and specifying the explicit permissions inside a share.

For example, if you have defined a Samba share called *share* and wish to give read-only permissions to the group of users known as "qa", but wanted to allow writing to the share by the group called "sysadmin" and the user named "vincent", then you could edit the */etc/samba/smb.conf* file and add the following entries under the *[share]* entry:

```
read list = @qa
write list = @sysadmin, vincent
```

Another possible Samba permission is to declare *administrative* permissions to a particular shared resource. Users having administrative permissions may read, write, or modify any information contained in the resource the user has been given explicit administrative permissions to.

For example, if you wanted to give the user *Melissa* administrative permissions to the *share* example, you would edit the */etc/samba/smb.conf* file, and add the following line under the *[share]* entry:

```
admin users = melissa
```

After editing */etc/samba/smb.conf*, reload Samba for the changes to take effect by running the following command:

```
sudo smbcontrol smb reload-config
```

## Filesystem permissions

Now that Samba has been configured to limit which groups have access to the shared directory, the filesystem permissions need to be checked.

Traditional Linux file permissions do not map well to Windows NT Access Control Lists (ACLs). Fortunately POSIX ACLs are available on Ubuntu servers, which provides more fine-grained control. For example, to enable ACLs on */srv* in an EXT3 filesystem, edit */etc/fstab* and add the *acl* option:

```
UUID=66bcdd2e-8861-4fb0-b7e4-e61c569fe17d /srv ext3 noatime,relatime,acl 0 1
```

Then remount the partition:

```
sudo mount -v -o remount /srv
```

**Note:**

This example assumes `/srv` is on a separate partition. If `/srv`, or wherever you have configured your share path, is part of the `/` partition then a reboot may be required.

To match the Samba configuration above, the “`sysadmin`” group will be given read, write, and execute permissions to `/srv/samba/share`, the “`qa`” group will be given read and execute permissions, and the files will be owned by the username “`Melissa`”. Enter the following in a terminal:

```
sudo chown -R melissa /srv/samba/share/
sudo chgrp -R sysadmin /srv/samba/share/
sudo setfacl -R -m g:qa:rx /srv/samba/share/
```

**Note:**

The `setfacl` command above gives *execute* permissions to all files in the `/srv/samba/share` directory, which you may or may not want.

Now from a Windows client you should notice the new file permissions are implemented. See [the `acl` and `setfacl` man pages](#) for more information on POSIX ACLs.

## Further reading

- For in-depth Samba configurations see the [Samba HOWTO Collection](#).
- The guide is also available in [printed format](#).
- O’Reilly’s [Using Samba](#) is also a good reference.
- [Chapter 18](#) of the Samba HOWTO Collection is devoted to security.
- For more information on Samba and ACLs see the [Samba ACLs page](#).
- The [Ubuntu Wiki Samba](#) page.

Ubuntu comes with the AppArmor security module, which provides mandatory access controls. The default AppArmor profile for Samba may need to be adapted to your configuration. More details on using AppArmor can be found [in this guide](#).

There are default AppArmor profiles for `/usr/sbin/smbd` and `/usr/sbin/nmbd`, the Samba daemon binaries, as part of the `apparmor-profiles` package.

## Install apparmor-profiles

To install the package, enter the following command from a terminal prompt:

```
sudo apt install apparmor-profiles apparmor-utils
```

**Note:**

This package contains profiles for several other binaries.

## AppArmor profile modes

By default, the profiles for `smbd` and `nmbd` are set to ‘`complain`’ mode. In this mode, Samba can work without modifying the profile, and only logs errors or violations. There is no need to add exceptions for the shares, as the `smbd` service unit takes care of doing that automatically via a helper script.

This is what an `ALLOWED` message looks like. It means that, were the profile not in `complain` mode, this action would have been denied instead (formatted into multiple lines here for better visibility):

```
Jun 30 14:41:09 ubuntu kernel: [621.478989] audit:
type=1400 audit(1656600069.123:418):
apparmor="ALLOWED" operation="exec" profile="smbd"
name="/usr/lib/x86_64-linux-gnu/samba/samba-bgqd" pid=4122 comm="smbd"
requested_mask="x" denied_mask="x" fsuid=0 ouid=0
target="smbd//null-/usr/lib/x86_64-linux-gnu/samba/samba-bgqd"
```

The alternative to ‘`complain`’ mode is ‘`enforce`’ mode, where any operations that violate policy are blocked. To place the profile into `enforce` mode and reload it, run:

```
sudo aa-enforce /usr/sbin/smbd
sudo apparmor_parser -r -W -T /etc/apparmor.d/usr.sbin.smbd
```

It's advisable to monitor `/var/log/syslog` for `audit` entries that contain AppArmor `DENIED` messages, or `/var/log/audit/audit.log` if you are running the `auditd` daemon. Actions blocked by AppArmor may surface as odd or unrelated errors in the application.

## Further reading:

- For more information on how to use AppArmor, including details of the profile modes, [the Debian AppArmor guide](#) may be helpful.

### Note:

This section is flagged as *legacy* because nowadays, Samba can be deployed in full Active Directory domain controller mode, and the old-style NT4 Primary Domain Controller is deprecated.

A Samba server can be configured to appear as a Windows NT4-style domain controller. A major advantage of this configuration is the ability to centralise user and machine credentials. Samba can also use multiple backends to store the user information.

## Primary domain controller

In this section, we'll install and configure Samba as a Primary Domain Controller (PDC) using the default `smbpasswd` backend.

### Install Samba

First, we'll install Samba, and `libpam-winbind` (to sync the user accounts), by entering the following in a terminal prompt:

```
sudo apt install samba libpam-winbind
```

### Configure Samba

Next, we'll configure Samba by editing `/etc/samba/smb.conf`. The *security* mode should be set to *user*, and the *workgroup* should relate to your organization:

```
workgroup = EXAMPLE
...
security = user
```

In the commented "Domains" section, add or uncomment the following (the last line has been split to fit the format of this document):

```
domain logons = yes
logon path = \\%N%\%U\profile
logon drive = H:
logon home = \\%N%\%U
logon script = logon.cmd
add machine script = sudo /usr/sbin/useradd -N -g machines -c Machine -d
 /var/lib/samba -s /bin/false %u
```

### Note:

If you wish to not use *Roaming Profiles* leave the `logon home` and `logon path` options commented out.

- `domain logons`  
Provides the `netlogon` service, causing Samba to act as a domain controller.
- `logon path`  
Places the user's Windows profile into their home directory. It is also possible to configure a `[profiles]` share placing all profiles under a single directory.
- `logon drive`  
Specifies the home directory local path.
- `logon home`  
Specifies the home directory location.
- `logon script`  
Determines the script to be run locally once a user has logged in. The script needs to be placed in the `[netlogon]` share.

- add machine script

A script that will automatically create the *Machine Trust Account* needed for a workstation to join the domain.

In this example the *machines* group will need to be created using the `addgroup` utility (see [Security - Users: Adding and Deleting Users](#) for details).

## Mapping shares

Uncomment the `[homes]` share to allow the `logon home` to be mapped:

```
[homes]
 comment = Home Directories
 browseable = no
 read only = no
 create mask = 0700
 directory mask = 0700
 valid users = %S
```

When configured as a domain controller, a `[netlogon]` share needs to be configured. To enable the share, uncomment:

```
[netlogon]
 comment = Network Logon Service
 path = /srv/samba/netlogon
 guest ok = yes
 read only = yes
 share modes = no
```

### Note:

The original `netlogon` share path is `/home/samba/netlogon`, but according to the Filesystem Hierarchy Standard (FHS), `/srv` is the correct location for site-specific data provided by the system.

Now create the `netlogon` directory, and an empty (for now) `logon.cmd` script file:

```
sudo mkdir -p /srv/samba/netlogon
sudo touch /srv/samba/netlogon/logon.cmd
```

You can enter any normal Windows logon script commands in `logon.cmd` to customise the client's environment.

Restart Samba to enable the new domain controller, using the following command:

```
sudo systemctl restart smbd.service nmbd.service
```

## Final setup tasks

Lastly, there are a few additional commands needed to set up the appropriate rights.

Since `root` is disabled by default, a system group needs to be mapped to the Windows *Domain Admins* group in order to join a workstation to the domain. Using the `net` utility, from a terminal enter:

```
sudo net groupmap add ntgroup="Domain Admins" unixgroup=sysadmin rid=512 type=d
```

You should change `sysadmin` to whichever group you prefer. Also, the user joining the domain needs to be a member of the `sysadmin` group, as well as a member of the system `admin` group. The `admin` group allows `sudo` use.

If the user does not have Samba credentials yet, you can add them with the `smbpasswd` utility. Change the `sysadmin` username appropriately:

```
sudo smbpasswd -a sysadmin
```

Also, rights need to be explicitly provided to the *Domain Admins* group to allow the *add machine script* (and other admin functions) to work. This is achieved by executing:

```
net rpc rights grant -U sysadmin "EXAMPLE\Domain Admins" SeMachineAccountPrivilege \
SePrintOperatorPrivilege SeAddUsersPrivilege SeDiskOperatorPrivilege \
SeRemoteShutdownPrivilege
```

You should now be able to join Windows clients to the Domain in the same manner as joining them to an NT4 domain running on a Windows server.

## Backup domain controller

With a Primary Domain Controller (PDC) on the network it is best to have a Backup Domain Controller (BDC) as well. This will allow clients to authenticate in case the PDC becomes unavailable.

When configuring Samba as a BDC you need a way to sync account information with the PDC. There are multiple ways of accomplishing this; secure copy protocol (SCP), `rsync`, or by using LDAP as the `passwd` backend.

Using LDAP is the most robust way to sync account information, because both domain controllers can use the same information in real time. However, setting up an LDAP server may be overly complicated for a small number of user and computer accounts. See [Samba - OpenLDAP Backend](#) for details.

First, install `samba` and `libpam-winbind`. From a terminal enter:

```
sudo apt install samba libpam-winbind
```

Now, edit `/etc/samba/smb.conf` and uncomment the following in the `[global]`:

```
workgroup = EXAMPLE
...
security = user
```

In the commented `Domains` uncomment or add:

```
domain logons = yes
domain master = no
```

Make sure a user has rights to read the files in `/var/lib/samba`. For example, to allow users in the `admin` group to SCP the files, enter:

```
sudo chgrp -R admin /var/lib/samba
```

Next, sync the user accounts, using SCP to copy the `/var/lib/samba` directory from the PDC:

```
sudo scp -r username@pdc:/var/lib/samba /var/lib
```

You can replace `username` with a valid username and `pdc` with the hostname or IP address of your actual PDC.

Finally, restart `samba`:

```
sudo systemctl restart smbd.service nmbd.service
```

You can test that your Backup Domain Controller is working by first stopping the Samba daemon on the PDC – then try to log in to a Windows client joined to the domain.

Another thing to keep in mind is if you have configured the `logon home` option as a directory on the PDC, and the PDC becomes unavailable, access to the user's `Home` drive will also be unavailable. For this reason it is best to configure the `logon home` to reside on a separate file server from the PDC and BDC.

## Further reading

- For in depth Samba configurations see the [Samba HOWTO Collection](#).
- The guide is also available [in printed format](#).
- O'Reilly's [Using Samba](#) is also a good reference.
- [Chapter 4](#) of the Samba HOWTO Collection explains setting up a Primary Domain Controller.
- [Chapter 5](#) of the Samba HOWTO Collection explains setting up a Backup Domain Controller.
- The [Ubuntu Wiki Samba](#) page.

### Note:

This section is flagged as *legacy* because nowadays, Samba 4 is best integrated with its own LDAP server in Active Directory mode. Integrating Samba with LDAP as described here covers the NT4 mode, which has been deprecated for many years.

This section covers the integration of Samba with LDAP. The Samba server's role will be that of a “standalone” server and the LDAP directory will provide the authentication layer in addition to containing the user, group, and machine account information that Samba requires in order to function (in any of its 3 possible roles). The pre-requisite is an OpenLDAP server configured with a directory that can accept authentication requests. See [Install LDAP and LDAP with Transport Layer Security](#) for details on fulfilling this requirement. Once those steps are completed, you will need to decide what specifically you want Samba to do for you and then configure it accordingly.

This guide will assume that the LDAP and Samba services are running on the same server and therefore use SASL EXTERNAL authentication whenever changing something under *cn=config*. If that is not your scenario, you will have to run those LDAP commands on the LDAP server.

## Install the software

There are two packages needed when integrating Samba with LDAP: `samba` and `smbldap-tools`.

Strictly speaking, the `smbldap-tools` package isn't needed, but unless you have some other way to manage the various Samba entities (users, groups, computers) in an LDAP context then you should install it.

Install these packages now:

```
sudo apt install samba smbldap-tools
```

## Configure LDAP

We will now configure the LDAP server so that it can accommodate Samba data. We will perform three tasks in this section:

- Import a schema
- Index some entries
- Add objects

### Samba schema

In order for OpenLDAP to be used as a backend for Samba, the DIT will need to use attributes that can properly describe Samba data. Such attributes can be obtained by introducing a Samba LDAP schema. Let's do this now.

The schema is found in the now-installed `samba` package and is already in the LDIF format. We can import it with one simple command:

```
sudo ldapadd -Q -Y EXTERNAL -H ldapi:/// -f /usr/share/doc/samba/examples/LDAP/samba.ldif
```

To query and view this new schema:

```
sudo ldapsearch -Q -LLL -Y EXTERNAL -H ldapi:/// -b cn=schema,cn=config 'cn=*samba*'
```

### Samba indices

Now that `slapd` knows about the Samba attributes, we can set up some indices based on them. Indexing entries is a way to improve performance when a client performs a filtered search on the DIT.

Create the file `samba_indices.ldif` with the following contents:

```
dn: olcDatabase={1}mdb,cn=config
changetype: modify
replace: olcDbIndex
olcDbIndex: objectClass eq
olcDbIndex: uidNumber,gidNumber eq
olcDbIndex: loginShell eq
olcDbIndex: uid,cn eq,sub
olcDbIndex: memberUid eq,sub
olcDbIndex: member,uniqueMember eq
olcDbIndex: sambaSID eq
olcDbIndex: sambaPrimaryGroupSID eq
olcDbIndex: sambaGroupType eq
olcDbIndex: sambaSIDList eq
olcDbIndex: sambaDomainName eq
olcDbIndex: default sub,eq
```

Using the `ldapmodify` utility load the new indices:

```
sudo ldapmodify -Q -Y EXTERNAL -H ldapi:/// -f samba_indices.ldif
```

If all went well you should see the new indices when using `ldapsearch`:

```
sudo ldapsearch -Q -LLL -Y EXTERNAL -H \
ldapi:/// -b cn=config olcDatabase={1}mdb olcDbIndex
```



## Adding Samba LDAP objects

Next, configure the `smbldap-tools` package to match your environment. The package comes with a configuration helper script called `smbldap-config`. Before running it, though, you should decide on two important configuration settings in `/etc/samba/smb.conf`:

- **netbios name**  
How this server will be known. The default value is derived from the server's hostname, but truncated at 15 characters.
- **workgroup**  
The workgroup name for this server, or, if you later decide to make it a domain controller, this will be the domain.

It's important to make these choices now because `smbldap-config` will use them to generate the config that will be later stored in the LDAP directory. If you run `smbldap-config` now and later change these values in `/etc/samba/smb.conf` there will be an inconsistency.

Once you are happy with `netbios name` and `workgroup`, proceed to generate the `smbldap-tools` configuration by running the configuration script which will ask you some questions:

```
sudo smbldap-config
```

Some of the more important ones:

- **workgroup name**  
Has to match what you will configure in `/etc/samba/smb.conf` later on.
- **ldap suffix**  
Has to match the LDAP suffix you chose when you configured the LDAP server.
- **other ldap suffixes**  
They are all relative to `ldap suffix` above. For example, for `ldap user suffix` you should use `ou=People`, and for `computer/machines`, use `ou=Computers`.
- **ldap master bind dn and bind password**  
Use the Root DN credentials.

The `smbldap-populate` script will then add the LDAP objects required for Samba. It will ask you for a password for the "domain root" user, which is also the "root" user stored in LDAP:

```
sudo smbldap-populate -g 10000 -u 10000 -r 10000
```

The `-g`, `-u` and `-r` parameters tell `smbldap-tools` where to start the numeric `uid` and `gid` allocation for the LDAP users. You should pick a range start that does not overlap with your local `/etc/passwd` users.

You can create a LDIF file containing the new Samba objects by executing `sudo smbldap-populate -e samba.ldif`. This allows you to look over the changes making sure everything is correct. If it is, rerun the script without the `'-e'` switch. Alternatively, you can take the LDIF file and import its data as per usual.

Your LDAP directory now has the necessary information to authenticate Samba users.

## Samba configuration

To configure Samba to use LDAP, edit its configuration file `/etc/samba/smb.conf` commenting out the default `passdb` backend parameter and adding some LDAP-related ones. Make sure to use the same values you used when running `smbldap-populate`:

```
passdb backend = tdbsam
workgroup = EXAMPLE

LDAP Settings
passdb backend = ldapsam:ldap://ldap01.example.com
ldap suffix = dc=example,dc=com
ldap user suffix = ou=People
ldap group suffix = ou=Groups
ldap machine suffix = ou=Computers
ldap idmap suffix = ou=Idmap
ldap admin dn = cn=admin,dc=example,dc=com
ldap ssl = start tls
ldap passwd sync = yes
```

Change the values to match your environment.

**Note:**

The `smb.conf` as shipped by the package is quite long and has many configuration examples. An easy way to visualise it without any comments is to run `testparm -s`.

Now inform Samba about the Root DN user's password (the one set during the installation of the `slapd` package):

```
sudo smbpasswd -W
```

As a final step to have your LDAP users be able to connect to Samba and authenticate, we need these users to also show up in the system as "Unix" users. Use SSSD for that as detailed in [Network User Authentication with SSSD](#).

Install `sssd-ldap`:

```
sudo apt install sssd-ldap
```

Configure `/etc/sss/sss.conf`:

```
[sss]
config_file_version = 2
domains = example.com

[domain/example.com]
id_provider = ldap
auth_provider = ldap
ldap_uri = ldap://ldap01.example.com
cache_credentials = True
ldap_search_base = dc=example,dc=com
```

Adjust permissions and start the service:

```
sudo chmod 0600 /etc/sss/sss.conf
sudo chown root:root /etc/sss/sss.conf
sudo systemctl start sssd
```

Restart the Samba services:

```
sudo systemctl restart smb.service nmbd.service
```

To quickly test the setup, see if `getent` can list the Samba groups:

```
$ getent group Replicators
Replicators*:552:
```

**Note:**

The names are case sensitive!

If you have existing LDAP users that you want to include in your new LDAP-backed Samba they will, of course, also need to be given some of the extra Samba specific attributes. The `smbpasswd` utility can do this for you:

```
sudo smbpasswd -a username
```

You will be prompted to enter a password. It will be considered as the new password for that user. Making it the same as before is reasonable. Note that this command cannot be used to create a new user from scratch in LDAP (unless you are using `ldapsam:trusted` and `ldapsam:editposix`, which are not covered in this guide).

To manage user, group, and machine accounts use the utilities provided by the `smbldap-tools` package. Here are some examples:

- To add a new user with a home directory:

```
sudo smbldap-useradd -a -P -m username
```

The `-a` option adds the Samba attributes, and the `-P` option calls the `smbldap-passwd` utility after the user is created allowing you to enter a password for the user. Finally, `-m` creates a local home directory. Test with the `getent` command:

```
getent passwd username
```

- To remove a user:

```
sudo smbldap-userdel username
```

In the above command, use the `-r` option to remove the user's home directory.

- To add a group:

```
sudo smbldap-groupadd -a groupname
```

As for *smbldap-useradd*, the *-a* adds the Samba attributes.

- To make an existing user a member of a group:

```
sudo smbldap-groupmod -m username groupname
```

The *-m* option can add more than one user at a time by listing them in comma-separated format.

- To remove a user from a group:

```
sudo smbldap-groupmod -x username groupname
```

- To add a Samba machine account:

```
sudo smbldap-useradd -t 0 -w username
```

Replace *username* with the name of the workstation. The *-t 0* option creates the machine account without a delay, while the *-w* option specifies the user as a machine account.

## Resources

- [Upstream documentation collection](#)
- [Upstream samba wiki](#)

Kerberos is a network authentication system based on the principal of a trusted third party. The other two parties being the user and the service the user wishes to authenticate to. Not all services and applications can use Kerberos, but for those that can, it brings the network environment one step closer to being Single Sign On (SSO).

This section covers installation and configuration of a Kerberos server, and some example client configurations.

## Overview

If you are new to Kerberos there are a few terms that are good to understand before setting up a Kerberos server. Most of the terms will relate to things you may be familiar with in other environments:

- *Principal*: any users, computers, and services provided by servers need to be defined as Kerberos Principals.
- *Instances*: are a variation for service principals. For example, the principal for an NFS service will have an instance for the hostname of the server, like `nfs/server.example.com@REALM`. Similarly admin privileges on a principal use an instance of `/admin`, like `john/admin@REALM`, differentiating it from `john@REALM`. These variations fit nicely with ACLs.
- *Realms*: the unique realm of control provided by the Kerberos installation. Think of it as the domain or group your hosts and users belong to. Convention dictates the realm should be in uppercase. By default, Ubuntu will use the DNS domain converted to uppercase (`EXAMPLE.COM`) as the realm.
- *Key Distribution Center*: (KDC) consist of three parts: a database of all principals, the authentication server, and the ticket granting server. For each realm there must be at least one KDC.
- *Ticket Granting Ticket*: issued by the Authentication Server (AS), the Ticket Granting Ticket (TGT) is encrypted in the user's password which is known only to the user and the KDC. This is the starting point for a user to acquire additional tickets for the services being accessed.
- *Ticket Granting Server*: (TGS) issues service tickets to clients upon request.
- *Tickets*: confirm the identity of the two principals. One principal being a user and the other a service requested by the user. Tickets establish an encryption key used for secure communication during the authenticated session.
- *Keytab Files*: contain encryption keys for a service or host extracted from the KDC principal database.

To put the pieces together, a Realm has at least one KDC, preferably more for redundancy, which contains a database of Principals. When a user principal logs into a workstation that is configured for Kerberos authentication, the KDC issues a Ticket Granting Ticket (TGT). If the user supplied credentials match, the user is authenticated and can then request tickets for Kerberized services from the Ticket Granting Server (TGS). The service tickets allow the user to authenticate to the service without entering another username and password.

## Resources

- For more information on MIT's version of Kerberos, see the [MIT Kerberos site](#).
- Also, feel free to stop by the [#ubuntu-server](#) and [#kerberos](#) IRC channels on [Libera.Chat](#) if you have Kerberos questions.
- [Another guide for installing Kerberos on Debian, includes PKINIT](#)

## Installation

For this discussion, we will create a MIT Kerberos domain with the following features (edit them to fit your needs):

- *Realm*: EXAMPLE.COM
- *Primary KDC*: kdc01.example.com
- *Secondary KDC*: kdc02.example.com
- *User principal*: ubuntu
- *Admin principal*: ubuntu/admin

Before installing the Kerberos server, a properly configured DNS server is needed for your domain. Since the Kerberos Realm by convention matches the domain name, this section uses the EXAMPLE.COM domain configured in the section [Primary Server](#) of the DNS documentation.

Also, Kerberos is a time sensitive protocol. If the local system time between a client machine and the server differs by more than five minutes (by default), the workstation will not be able to authenticate. To correct the problem all hosts should have their time synchronized using the same *Network Time Protocol (NTP)* server. Check out the [NTP chapter](#) for more details.

The first step in creating a Kerberos Realm is to install the `krb5-kdc` and `krb5-admin-server` packages. From a terminal enter:

```
sudo apt install krb5-kdc krb5-admin-server
```

You will be asked at the end of the install to supply the hostname for the Kerberos and Admin servers, which may or may not be the same server, for the realm. Since we are going to create the realm, and thus these servers, type in the full hostname of this server.

### Note

By default the realm name will be domain name of the KDC server.

Next, create the new realm with the `kdb5_newrealm` utility:

```
sudo krb5_newrealm
```

It will ask you for a database master password, which is used to encrypt the local database. Chose a secure password: its strength is not verified for you.

## Configuration

The questions asked during installation are used to configure the `/etc/krb5.conf` and `/etc/krb5kdc/kdc.conf` files. The former is used by the kerberos 5 libraries, and the latter configures the KDC. If you need to adjust the Key Distribution Center (KDC) settings simply edit the file and restart the `krb5-kdc` daemon. If you need to reconfigure Kerberos from scratch, perhaps to change the realm name, you can do so by typing

```
sudo dpkg-reconfigure krb5-kdc
```

### Note

The manpage for `krb5.conf` is in the `krb5-doc` package.

Let's create our first principal. Since there is no principal create yet, we need to use `kadmin.local`, which uses a local unix socket to talk to the KDC, and requires root privileges:

```
$ sudo kadmin.local
Authenticating as principal root/admin@EXAMPLE.COM with password.
kadmin.local: addprinc ubuntu
WARNING: no policy specified for ubuntu@EXAMPLE.COM; defaulting to no policy
Enter password for principal "ubuntu@EXAMPLE.COM":
Re-enter password for principal "ubuntu@EXAMPLE.COM":
Principal "ubuntu@EXAMPLE.COM" created.
```

```
kadmin.local: quit
```

To be able to use `kadmin` remotely, we should create an *admin principal*. Convention suggests it should be an *admin instance*, as that also makes creating generic ACLs easier. Let's create an *admin* instance for the *ubuntu* principal:

```
$ sudo kadmin.local
Authenticating as principal root/admin@EXAMPLE.COM with password.
kadmin.local: addprinc ubuntu/admin
WARNING: no policy specified for ubuntu/admin@EXAMPLE.COM; defaulting to no policy
Enter password for principal "ubuntu/admin@EXAMPLE.COM":
Re-enter password for principal "ubuntu/admin@EXAMPLE.COM":
Principal "ubuntu/admin@EXAMPLE.COM" created.
kadmin.local: quit
```

Next, the new admin principal needs to have the appropriate Access Control List (ACL) permissions. The permissions are configured in the `/etc/krb5kdc/kadm5.acl` file:

```
ubuntu/admin@EXAMPLE.COM *
```

You can also use a more generic form for this ACL:

```
*/admin@EXAMPLE.COM *
```

The above will grant all privileges to any *admin instance* of a principal. See the `kadm5.acl` manpage for details.

Now restart the `krb5-admin-server` for the new ACL to take affect:

```
sudo systemctl restart krb5-admin-server.service
```

The new user principal can be tested using the `kinit` utility:

```
$ kinit ubuntu/admin
Password for ubuntu/admin@EXAMPLE.COM:
```

After entering the password, use the `klist` utility to view information about the Ticket Granting Ticket (TGT):

```
$ klist
Ticket cache: FILE:/tmp/krb5cc_1000
Default principal: ubuntu/admin@EXAMPLE.COM
```

```
Valid starting Expires Service principal
04/03/20 19:16:57 04/04/20 05:16:57 krbtgt/EXAMPLE.COM@EXAMPLE.COM
 renew until 04/04/20 19:16:55
```

Where the cache filename `krb5cc_1000` is composed of the prefix `krb5cc_` and the user id (uid), which in this case is `1000`.

`kinit` will inspect `/etc/krb5.conf` to find out which KDC to contact, and its address. The KDC can also be found via DNS lookups for special TXT and SRV records. You can add these records to your `example.com` DNS zone:

```
_kerberos._udp.EXAMPLE.COM. IN SRV 1 0 88 kdc01.example.com.
_kerberos._tcp.EXAMPLE.COM. IN SRV 1 0 88 kdc01.example.com.
_kerberos._udp.EXAMPLE.COM. IN SRV 10 0 88 kdc02.example.com.
_kerberos._tcp.EXAMPLE.COM. IN SRV 10 0 88 kdc02.example.com.
_kerberos-adm._tcp.EXAMPLE.COM. IN SRV 1 0 749 kdc01.example.com.
_kpasswd._udp.EXAMPLE.COM. IN SRV 1 0 464 kdc01.example.com.
```

See the [DNS chapter](#) for detailed instructions on setting up DNS.

A very quick and useful way to troubleshoot what `kinit` is doing is to set the environment variable `KRB5_TRACE` to a file, or `stderr`, and it will show extra information. The output is quite verbose:

```
$ KRB5_TRACE=/dev/stderr kinit ubuntu/admin
[2898] 1585941845.278578: Getting initial credentials for ubuntu/admin@EXAMPLE.COM
[2898] 1585941845.278580: Sending unauthenticated request
[2898] 1585941845.278581: Sending request (189 bytes) to EXAMPLE.COM
[2898] 1585941845.278582: Resolving hostname kdc01.example.com
(...)
```

Your new Kerberos Realm is now ready to authenticate clients.

The specific steps to enable Kerberos for a service can vary a bit, but in general the following is needed:

- a principal for the service: usually `service/host@REALM`

- a keytab accessible to the service wherever it's running: usually in `/etc/krb5.keytab`

For example, let's create a principal for an LDAP service running on the `ldap-server.example.com` host:

```
ubuntu@ldap-server:~$ sudo kadmin -p ubuntu/admin
Authenticating as principal ubuntu/admin with password.
Password for ubuntu/admin@EXAMPLE.COM:
kadmin: addprinc -randkey ldap/ldap-server.example.com
No policy specified for ldap/ldap-server.example.com@EXAMPLE.COM; defaulting to no policy
Principal "ldap/ldap-server.example.com@EXAMPLE.COM" created.
```

Let's dig a bit into what is happening here:

- the `kadmin` command is being run in the `ldap-server` machine, not on the KDC. We are using `kadmin` remotely
- it's being run with `sudo`, the reason will become clear later
- we are logged in on the server as `ubuntu`, but specifying a `ubuntu/admin` principal. Remember the `ubuntu` principal has no special privileges
- the name of the principal we are creating follows the pattern `service/hostname`
- in order to select a random secret, we pass the `-randkey` parameter. Otherwise we would be asked to type in a password.

With the principal created, we need to extract the key from the KDC and store it in the `ldap-server` host, so that the `ldap` service can use it to authenticate itself with the KDC. Still in the same `kadmin` session:

```
kadmin: ktadd ldap/ldap-server.example.com
Entry for principal ldap/ldap-server.example.com with kvno 2, encryption type aes256-cts-hmac-sha1-96 added to keytab FILE:/etc/krb5.keytab.
Entry for principal ldap/ldap-server.example.com with kvno 2, encryption type aes128-cts-hmac-sha1-96 added to keytab FILE:/etc/krb5.keytab.
```

This is why he needed to run `kadmin` with `sudo`: so that it can write to `/etc/krb5.keytab`. This is the system keytab file, which is the default file for all keys that might be needed for services on this host. And we can list them with `klist`. Back in the shell:

```
$ sudo klist -k
Keytab name: FILE:/etc/krb5.keytab
KVNO Principal

 2 ldap/ldap-server.example.com@EXAMPLE.COM
 2 ldap/ldap-server.example.com@EXAMPLE.COM
```

If you don't have the `kadmin` utility on the target host, one alternative is to extract the keys on a different host and into a different file, and then transfer this file *securely* to the target server. For example:

```
kadmin: ktadd -k /home/ubuntu/ldap.keytab ldap/ldap-server.example.com
Entry for principal ldap/ldap-server.example.com with kvno 3, encryption type aes256-cts-hmac-sha1-96 added to keytab WRFILE:/home/ubuntu/ldap.keytab.
Entry for principal ldap/ldap-server.example.com with kvno 3, encryption type aes128-cts-hmac-sha1-96 added to keytab WRFILE:/home/ubuntu/ldap.keytab.
```

**Note**

Notice how the `kvno` changed from 2 to 3 in the example above, when using `ktadd` a second time? This is the key version, and it basically invalidated the key with `kvno 2` that was extracted before. Everytime a key is extracted with `ktadd`, its version is bumped and that invalidates the previous ones!

In this case, as long as the target location is writable, you don't even have to run `kadmin` with `sudo`.

Then use `scp` to transfer it to the target host:

```
$ scp /home/ubuntu/ldap.keytab ldap-server.example.com:
```

And over there copy it to `/etc/krb5.keytab`, making sure it's mode `0600` and owned by `root:root`.

Encryption is at the heart of Kerberos, and it supports multiple cryptographic algorithms. The default choices are good enough for most deployments, but specific situations might need to tweak these settings.

This document will explain the basic configuration parameters of Kerberos that control the selection of encryption algorithms used in a Kerberos deployment.

## Server-side configuration

There are two main server-side configuration parameters that control the encryption types used on the server for its database and its collection of principals. Both exist in `/etc/krb5kdc/kdc.conf` inside the `[realms]` section and are as follows:

- `master_key_type`  
Specifies the key type of the master key. This is used to encrypt the database, and the default is `aes256-cts-hmac-sha1-96`.
- `supported_encyptypes`  
Specifies the default key/salt combinations of principals for this realm. The default is `aes256-cts-hmac-sha1-96:normal aes128-cts-hmac-sha1-96:normal`, and the encryption types should be listed in order of preference.

Possible values for the encryption algorithms are listed in the [MIT documentation on encryption types](#), and the salt types can be seen [in the MIT keysalt lists](#).

Here is an example showing the default values (other settings removed for brevity):

```
[realms]
 EXAMPLE.INTERNAL = {
 (...)
 master_key_type = aes256-cts
 supported_encyptypes = aes256-cts-hmac-sha1-96:normal aes128-cts-hmac-sha1-96:normal
 (...)
 }
```

The master key is created once per realm, when the realm is bootstrapped. That is usually done with the `krb5_newrealm` tool (see [Kerberos Server](#) for details). You can check the master key type with either of these commands on the KDC server:

```
$ sudo kadmin.local
kadmin.local: getprinc K/M
Principal: K/M@EXAMPLE.INTERNAL
(...)
Number of keys: 1
Key: vno 1, aes256-cts-hmac-sha1-96
(...)
```

```
$ sudo klist -ke /etc/krb5kdc/stash
Keytab name: FILE:/etc/krb5kdc/stash
KVNO Principal
```

```

 1 K/M@EXAMPLE.INTERNAL (aes256-cts-hmac-sha1-96)
```

When a new Kerberos principal is created through the `kadmind` service (via the `kadmin` or `kadmin.local` utilities), the types of encryption keys it will get are controlled via the `supported_encyptypes` configuration parameter.

For example, let's create an `ubuntu` principal, and check the keys that were created for it (output abbreviated):

```
$ sudo kadmin.local
Authenticating as principal root/admin@EXAMPLE.INTERNAL with password.
kadmin.local: addprinc ubuntu
No policy specified for ubuntu@EXAMPLE.INTERNAL; defaulting to no policy
Enter password for principal "ubuntu@EXAMPLE.INTERNAL":
Re-enter password for principal "ubuntu@EXAMPLE.INTERNAL":
Principal "ubuntu@EXAMPLE.INTERNAL" created.
```

```
kadmin.local: getprinc ubuntu
Principal: ubuntu@EXAMPLE.INTERNAL
(...)
Number of keys: 2
Key: vno 1, aes256-cts-hmac-sha1-96
Key: vno 1, aes128-cts-hmac-sha1-96
(...)
```

Two keys were created for the `ubuntu` principal, following the default setting of `supported_encyptypes` in `kdc.conf` for this realm.

**Note:**

The server config `supported_etypes` has the *default* list of key types that are created for a principal. This list applies to the moment when that principal is **created** by `kadmin`. Changing that setting after the fact won't affect the keys that the principal in question has after that event. In particular, principals can be created with specific key types regardless of the `supported_etypes` setting. See the `-e` parameter for the `kadmin add_principal` command.

If we had `supported_etypes` set to `aes256-sha2:normal aes128-sha2:normal camellia256-cts:normal` in `kdc.conf`, then the `ubuntu` principal would get three key types:

```
kadmin.local: getprinc ubuntu
Principal: ubuntu@EXAMPLE.INTERNAL
(...)
Number of keys: 3
Key: vno 1, aes256-cts-hmac-sha384-192
Key: vno 1, aes128-cts-hmac-sha256-128
Key: vno 1, camellia256-cts-cmac
```

**Note:**

Bootstrapping a new Kerberos realm via the `krb5_newrealm` command also creates some system principals required by Kerberos, such as `kadmin/admin`, `kadmin/changepw` and others. They will all also get the same number of keys each: one per encryption type in `supported_etypes`.

## Client-side configuration

When we say “client-side”, we really mean “applications linked with the Kerberos libraries”. These live on the server too, so keep that in mind.

The encryption types supported by the Kerberos libraries are defined in the `/etc/krb5.conf` file, inside the `[libdefaults]` section, via the `permitted_etypes` parameter.

Example:

```
[libdefaults]
(...)
permitted_etypes = aes256-cts-hmac-sha1-96 aes128-cts-hmac-sha1-96
```

This parameter contains a space-separated list of encryption type names, in order of preference. Default value: `aes256-cts-hmac-sha1-96 aes128-cts-hmac-sha1-96 aes256-cts-hmac-sha384-192 aes128-cts-hmac-sha256-128 des3-cbc-sha1 arcfour-hmac-md5 camellia256-cts-cmac camellia128-cts-cmac`.

Possible values for the encryption algorithms are listed in [the MIT documentation](#) (same ones as for the KDC).

**Note:**

There are more encryption-related parameters in `krb5.conf`, but most take their defaults from `permitted_etypes`. See the [MIT libdefaults documentation](#) for more information.

## Putting it all together

When a client performs Kerberos authentication and requests a ticket from the KDC, the encryption type used in that ticket is decided by picking the common set of:

- The encryption types supported by the server for that principal
- The encryption types supported by the client

If there is no common algorithm between what the client accepts, and what the server has to offer for that specific principal, then `kinit` will fail.

For example, if the principal on the server has:

```
kadmin.local: getprinc ubuntu
Principal: ubuntu@EXAMPLE.INTERNAL
(...)
Number of keys: 2
Key: vno 1, aes256-cts-hmac-sha384-192
Key: vno 1, aes128-cts-hmac-sha256-128
```

And the client's `krb5.conf` has:

```
permitted_etypes = aes256-sha1 aes128-sha1
```



Then `kinit` will fail, because the client only supports `sha1` variants, and the server only has `sha2` to offer for that particular principal the client is requesting:

```
$ kinit ubuntu
```

```
kinit: Generic error (see e-text) while getting initial credentials
```

The server log (`journalctl -u krb5-admin-server.service`) will have more details about the error:

```
Apr 19 19:31:49 j-kdc krb5kdc[8597]: AS_REQ (2 etypes {aes256-cts-hmac-sha1-96(18), aes128-cts-hmac-sha1-96(17)}) fd42:78f4:b1c4:3964:216:3eff:feda:118c: GET_LOCAL_TGT: ubuntu@EXAMPLE.INTERNAL for krbtgt/EXAMPLE.INTERNAL@EXA
```

This log says that there was an `AS-REQ` request which accepted two encryption types, but there was no matching key type on the server database for that principal.

## Changing encryption types

Changing encryption types of an existing Kerberos realm is no small task. Just changing the configuration settings won't recreate existing keys, nor add new ones. The modifications have to be done in incremental steps.

MIT Kerberos has a [guide on updating encryption types](#) that covers many scenarios, including deployments with multiple replicating servers:

## References

- [Encryption types in MIT Kerberos](#)
- [krb5.conf encryption related configurations options](#)
- [Migrating away from older encryption types](#)
- [kdc.conf manpage](#)
- [krb5.conf manpage](#)
- [Kerberos V5 concepts](#)

Once you have one Key Distribution Center (KDC) on your network, it is good practice to have a Secondary KDC in case the primary becomes unavailable. Also, if you have Kerberos clients that are in different networks (possibly separated by routers using NAT), it is wise to place a secondary KDC in each of those networks.

### Note

The native replication mechanism explained here relies on a cronjob, and essentially dumps the DB on the primary and loads it back up on the secondary. You may want to take a look at using the `klldap` backend which can use the OpenLDAP replication mechanism. It is explained further below.

First, install the packages, and when asked for the Kerberos and Admin server names enter the name of the Primary KDC:

```
sudo apt install krb5-kdc krb5-admin-server
```

Once you have the packages installed, create the host principals for both KDCs. From a terminal prompt, enter:

```
$ kadmin -q "addprinc -randkey host/kdc01.example.com"
$ kadmin -q "addprinc -randkey host/kdc02.example.com"
```

### Note

The `kadmin` command defaults to using a principal like `username/admin@EXAMPLE.COM`, where `username` is your current shell user. If you need to override that, use `-p <principal-you-want>`

Extract the `key` file for the `kdc02` principal, which is this server we are on::

```
$ sudo kadmin -p ubuntu/admin -q "ktadd host/kdc02.example.com"
```

Next, there needs to be a `kpropd.acl` file on each KDC that lists all KDCs for the Realm. For example, on both primary and secondary KDC, create `/etc/krb5kdc/kpropd.acl`:

```
host/kdc01.example.com@EXAMPLE.COM
host/kdc02.example.com@EXAMPLE.COM
```

### Note

It's customary to allow both KDCs because one may want to switch their roles if one goes bad. For such an eventuality, both are already listed here.

Create an empty database on the *Secondary KDC*:

```
$ sudo kdb5_util create -s
```

Now install kpropd daemon, which listens for connections from the kprop utility from the primary kdc:

```
$ sudo apt install krb5-kpropd
```

The service will be running right after installation.

From a terminal on the *Primary KDC*, create a dump file of the principal database:

```
$ sudo kdb5_util dump /var/lib/krb5kdc/dump
```

Still on the *Primary KDC*, extract its *key*:

```
$ sudo kadmin.local -q "ktadd host/kdc01.example.com"
```

On the *Primary KDC*, run the kprop utility to push the database dump made before to the Secondary KDC:

```
$ sudo kprop -r EXAMPLE.COM -f /var/lib/krb5kdc/dump kdc02.example.com
Database propagation to kdc02.example.com: SUCCEEDED
```

Note the *SUCCEEDED* message, which signals that the propagation worked. If there is an error message check `/var/log/syslog` on the secondary KDC for more information.

You may also want to create a cron job to periodically update the database on the Secondary KDC. For example, the following will push the database every hour:

```
m h dom mon dow command
0 * * * * root /usr/sbin/kdb5_util dump /var/lib/krb5kdc/dump && /usr/sbin/kprop -r EXAMPLE.COM -
f /var/lib/krb5kdc/dump kdc02.example.com
```

Finally, start the `krb5-kdc` daemon on the Secondary KDC:

```
$ sudo systemctl start krb5-kdc.service
```

### Note

The *Secondary KDC* does not run an admin server, since it's a read-only copy

From now on, you can specify both KDC servers in `/etc/krb5.conf` for the `EXAMPLE.COM` realm, in any host participating in this realm (including `kdc01` and `kdc02`), but remember that there can only be one admin server and that's the one running on `kdc01`:

```
[realms]
 EXAMPLE.COM = {
 kdc = kdc01.example.com
 kdc = kdc02.example.com
 admin_server = kdc01.example.com
 }
```

The *Secondary KDC* should now be able to issue tickets for the Realm. You can test this by stopping the `krb5-kdc` daemon on the Primary KDC, then by using `kinit` to request a ticket. If all goes well you should receive a ticket from the Secondary KDC. Otherwise, check `/var/log/syslog` and `/var/log/auth.log` in the Secondary KDC.

This section covers configuring a Linux system as a Kerberos client. This will allow access to any kerberized services once a user has successfully logged into the system.

Note that Kerberos alone is not enough for a user to exist in a Linux system. Meaning, we cannot just point the system at a kerberos server and expect all the kerberos principals to be able to *login* on the linux system, simply because these users do not *exist* locally. Kerberos only provides authentication: it doesn't know about user groups, Linux uids and gids, home directories, etc. Normally another network source is used for this information, such as an LDAP or Windows server, and, in the old days, NIS was used for that as well.

## Installation

If you have local users matching the principals in a Kerberos realm, and just want to switch the authentication from local to remote using Kerberos, you can follow this section. This is not a very usual scenario, but serves to highlight the separation between user authentication and user information (full name, uid, gid, home directory, groups, etc). If you just want to be able to grab tickets and use them, it's enough to install `krb5-user` and run `kinit`.

We are going to use `sssd` with a trick so that it will fetch the user information from the local system files, instead of a remote source which is the common case.

To install the packages enter the following in a terminal prompt:

```
$ sudo apt install krb5-user sssd-krb5
```

You will be prompted for the addresses of your KDCs and admin servers. If you have been following this chapter so far, the KDCs will be: `kdc01.example.com kdc02.example.com` (space separated)

And the admin server will be: `kdc01.example.com`. Remember that `kdc02` is a read-only copy of the primary KDC, so it doesn't run an admin server.

### Note

If you have added the appropriate SRV records to DNS, none of those prompts will need answering.

## Configuration

If you missed the questions earlier, you can reconfigure the package to fill them in again: `sudo dpkg-reconfigure krb5-config`.

You can test the kerberos configuration by requesting a ticket using the `kinit` utility. For example:

```
$ kinit ubuntu
Password for ubuntu@EXAMPLE.COM:
```

### Note

`kinit` doesn't need for the principal to exist as a local user in the system. In fact, you can `kinit` any principal you want. If you don't specify one, then the tool will use the username of whoever is running `kinit`.

The only remaining configuration now is for `sssd`. Create the file `/etc/sssds/sssds.conf` with the following content:

```
[sssds]
config_file_version = 2
services = pam
domains = example.com

[pam]

[domain/example.com]
id_provider = proxy
proxy_lib_name = files
auth_provider = krb5
krb5_server = kdc01.example.com,kdc02.example.com
krb5_kpasswd = kdc01.example.com
krb5_realm = EXAMPLE.COM
```

The above configuration will use kerberos for *authentication* (`auth_provider`), but will use the local system users for user and group information (`id_provider`).

Adjust the permissions of the config file and start `sssd`:

```
$ sudo chown root:root /etc/sssds/sssds.conf
$ sudo chmod 0600 /etc/sssds/sssds.conf
$ sudo systemctl start sssds
```

Just by having installed `sssd` and its dependencies, PAM will already have been configured to use `sssd`, with a fallback to local user authentication. To try it out, if this is a workstation, simply switch users (in the GUI), or open a login terminal (CTRL-ALT-<number>), or spawn a login shell with `sudo login`, and try logging in using the name of a kerberos principal. Remember that this user must already exist on the local system:

```
$ sudo login
focal-krb5-client login: ubuntu
Password:
Welcome to Ubuntu Focal Fossa (development branch) (GNU/Linux 5.4.0-21-generic x86_64)
```

(...)

```
Last login: Thu Apr 9 21:23:50 UTC 2020 from 10.20.20.1 on pts/0
$ klist
Ticket cache: FILE:/tmp/krb5cc_1000_NlfnSX
Default principal: ubuntu@EXAMPLE.COM
```

```
Valid starting Expires Service principal
04/09/20 21:36:12 04/10/20 07:36:12 krbtgt/EXAMPLE.COM@EXAMPLE.COM
 renew until 04/10/20 21:36:12
```

And you will have a Kerberos ticket already right after login.

Kerberos supports a few database backends. The default one is what we have been using so far, called *db2*. The [DB Types](#) documentation shows all the options, one of which is LDAP.

There are several reasons why one would want to have the Kerberos principals stored in LDAP as opposed to a local on-disk database. There are also cases when it is not a good idea. Each site has to evaluate the pros and cons. Here are a few:

- the OpenLDAP replication is faster and more robust than the native Kerberos one, based on a cron job
- setting things up with the LDAP backend isn't exactly trivial and shouldn't be attempted by administrators without prior knowledge of OpenLDAP
- as highlighted in [LDAP section of DB Types](#), since `krb5kdc` is single threaded there may be higher latency in servicing requests when using the OpenLDAP backend
- if you already have OpenLDAP setup for other things, like storing users and groups, adding the Kerberos attributes to the same mix might be beneficial and can provide a nice integrated story

This section covers configuring a primary and secondary kerberos server to use OpenLDAP for the principal database. Note that as of version 1.18, the KDC from MIT Kerberos [does not support](#) a primary KDC using a read-only consumer (secondary) LDAP server. What we have to consider here is that a Primary KDC is read-write, and it needs a read-write backend. The Secondaries can use both a read-write and read-only backend, because they are expected to be read-only. Therefore there are only some possible layouts we can use:

1. Simple case: Primary KDC connected to primary OpenLDAP, Secondary KDC connected to both Primary and Secondary OpenLDAP
2. Extended simple case: Multiple Primary KDCs connected to one Primary OpenLDAP, and multiple Secondary KDCs connected to Primary and Secondary OpenLDAP
3. OpenLDAP with multi-master replication: multiple primary KDCs connected to all primary OpenLDAP servers

We haven't covered OpenLDAP multi-master replication in this guide, so we will show the first case only. The second scenario is an extension: just add another primary KDC to the mix, talking to the same primary OpenLDAP server.

## Configuring OpenLDAP

We are going to install the OpenLDAP server on the same host as the KDC, to simplify the communication between them. In such a setup, we can use the `ldapi:///` transport, which is via an unix socket, and don't need to setup SSL certificates to secure the communication between the Kerberos services and OpenLDAP. Note, however, that SSL is still needed for the OpenLDAP replication. See [LDAP with TLS](#) for details.

If you want to use an existing OpenLDAP server that you have somewhere else, that's of course also possible, but keep in mind that you should then use SSL for the communication between the KDC and this OpenLDAP server.

First, the necessary *schema* needs to be loaded on an OpenLDAP server that has network connectivity to the Primary and Secondary KDCs. The rest of this section assumes that you also have LDAP replication configured between at least two servers. For information on setting up OpenLDAP see [OpenLDAP Server](#).

### Note

`cn=admin,dc=example,dc=com` is a default admin user that is created during the installation of the `slapd` package (the OpenLDAP server). The domain component will change for your server, so adjust accordingly.

- Install the necessary packages (it's assumed that OpenLDAP is already installed):

```
sudo apt install krb5-kdc-ldap krb5-admin-server
```

- Next, extract the `kerberos.schema.gz` file:

```
sudo cp /usr/share/doc/krb5-kdc-ldap/kerberos.schema.gz /etc/ldap/schema/
sudo gunzip /etc/ldap/schema/kerberos.schema.gz
```

- The *kerberos* schema needs to be added to the `cn=config` tree. This schema file needs to be converted to LDIF format before it can be added. For that we will use a helper tool, called `schema2ldif`, provided by the package of the same name which is available in the Universe archive:

```
sudo apt install schema2ldif
```

- To import the kerberos schema, run:

```

$ sudo ldap-schema-manager -i kerberos.schema
SASL/EXTERNAL authentication started
SASL username: gidNumber=0+uidNumber=0,cn=peercred,cn=external,cn=auth
SASL SSF: 0
executing 'ldapadd -Y EXTERNAL -H ldapi:/// -f /etc/ldap/schema/kerberos.ldif'
SASL/EXTERNAL authentication started
SASL username: gidNumber=0+uidNumber=0,cn=peercred,cn=external,cn=auth
SASL SSF: 0
adding new entry "cn=kerberos,cn=schema,cn=config"

```

- With the new schema loaded, let's index an attribute often used in searches:

```

$ sudo ldapmodify -Q -Y EXTERNAL -H ldapi:/// <<EOF
dn: olcDatabase={1}mdb,cn=config
add: olcDbIndex
olcDbIndex: krbPrincipalName eq,pres,sub
EOF

```

modifying entry "olcDatabase={1}mdb,cn=config"

- Let's create LDAP entries for the Kerberos administrative entities that will contact the OpenLDAP server to perform operations. There are two:
  - *ldap\_kdc\_dn*: needs to have read rights on the realm container, principal container and realm sub-trees. If *disable\_last\_success* and *disable\_lockout* are not set, however, then *ldap\_kdc\_dn* needs write access to the kerberos container just like the admin dn below.
  - *ldap\_kadmin\_dn*: needs to have read and write rights on the realm container, principal container and realm sub-trees

Here is the command to create these entities:

```

$ ldapadd -x -D cn=admin,dc=example,dc=com -W <<EOF
dn: uid=kdc-service,dc=example,dc=com
uid: kdc-service
objectClass: account
objectClass: simpleSecurityObject
userPassword: {CRYPT}x
description: Account used for the Kerberos KDC

dn: uid=kadmin-service,dc=example,dc=com
uid: kadmin-service
objectClass: account
objectClass: simpleSecurityObject
userPassword: {CRYPT}x
description: Account used for the Kerberos Admin server
EOF
Enter LDAP Password:
adding new entry "uid=kdc-service,dc=example,dc=com"

```

adding new entry "uid=kadmin-service,dc=example,dc=com"

Now let's set a password for them. Note that first the tool asks for the password you want for the specified user dn, and then for the password of the *cn=admin* dn:

```

$ ldappasswd -x -D cn=admin,dc=example,dc=com -W -S uid=kdc-service,dc=example,dc=com
New password: <-- password you want for uid-kdc-service
Re-enter new password:
Enter LDAP Password: <-- password for the dn specified with the -D option

```

Repeat for the uid=kadmin-service dn. These passwords will be needed later.

You can test these with ldapwhoami:

```

$ ldapwhoami -x -D uid=kdc-service,dc=example,dc=com -W
Enter LDAP Password:
dn:uid=kdc-service,dc=example,dc=com

```

- Finally, update the Access Control Lists (ACL). These can be tricky, as it highly depends on what you have defined already. By default, the slapd package configures your database with the following ACLs:

```

olcAccess: {0}to attrs=userPassword by self write by anonymous auth by * none
olcAccess: {1}to attrs=shadowLastChange by self write by * read
olcAccess: {2}to * by * read

```

We need to insert new rules before the final to \* by \* read one, to control access to the Kerberos related entries and attributes:

```

$ sudo ldapmodify -Q -Y EXTERNAL -H ldapi:/// <<EOF
dn: olcDatabase={1}mdb,cn=config
add: olcAccess
olcAccess: {2}to attrs=krbPrincipalKey
 by anonymous auth
 by dn.exact="uid=kdc-service,dc=example,dc=com" read
 by dn.exact="uid=kadmin-service,dc=example,dc=com" write
 by self write
 by * none
-
add: olcAccess
olcAccess: {3}to dn.subtree="cn=krbContainer,dc=example,dc=com"
 by dn.exact="uid=kdc-service,dc=example,dc=com" read
 by dn.exact="uid=kadmin-service,dc=example,dc=com" write
 by * none
EOF

```

modifying entry "olcDatabase={1}mdb,cn=config"

This will make the existing {2} rule become {4}. Check with `sudo slapcat -b cn=config` (the output below was reformatted a bit for clarity):

```

olcAccess: {0}to attrs=userPassword
 by self write
 by anonymous auth
 by * none
olcAccess: {1}to attrs=shadowLastChange
 by self write
 by * read
olcAccess: {2}to attrs=krbPrincipalKey by anonymous auth
 by dn.exact="uid=kdc-service,dc=example,dc=com" read
 by dn.exact="uid=kadmin-service,dc=example,dc=com" write
 by self write
 by * none
olcAccess: {3}to dn.subtree="cn=krbContainer,dc=example,dc=com"
 by dn.exact="uid=kdc-service,dc=example,dc=com" read
 by dn.exact="uid=kadmin-service,dc=example,dc=com" write
 by * none
olcAccess: {4}to * by * read

```

That's it, your LDAP directory is now ready to serve as a Kerberos principal database.

## Primary KDC Configuration (LDAP)

With OpenLDAP configured it is time to configure the KDC. In this example we are doing it in the same OpenLDAP server to take advantage of local unix socket communication.

- Reconfigure the `krb5-config` package if needed to get a good starting point with `/etc/krb5.conf`:

```
sudo dpkg-reconfigure krb5-config
```

- Now edit `/etc/krb5.conf` adding the `database_module` option to the `EXAMPLE.COM` realm section:

```

[realms]
 EXAMPLE.COM = {
 kdc = kdc01.example.com
 kdc = kdc02.example.com
 admin_server = kdc01.example.com
 default_domain = example.com
 database_module = openldap_ldapconf
 }

```

Then also add these new sections:

```
[dbdefaults]
 ldap_kerberos_container_dn = cn=krbContainer,dc=example,dc=com

[dbmodules]
 openldap_ldapconf = {
 db_library = kldap

 # if either of these is false, then the ldap_kdc_dn needs to
 # have write access
 disable_last_success = true
 disable_lockout = true

 # this object needs to have read rights on
 # the realm container, principal container and realm sub-trees
 ldap_kdc_dn = "uid=kdc-service,dc=example,dc=com"

 # this object needs to have read and write rights on
 # the realm container, principal container and realm sub-trees
 ldap_kadmin_dn = "uid=kadmin-service,dc=example,dc=com"

 ldap_service_password_file = /etc/krb5kdc/service.keyfile
 ldap_servers = ldapi:///
 ldap_conns_per_server = 5
 }
```

- Next, use the `kdb5_ldap_util` utility to create the realm:

```
$ sudo kdb5_ldap_util -D cn=admin,dc=example,dc=com create -subtrees dc=example,dc=com -r EXAMPLE.COM -
s -H ldapi:///
Password for "cn=admin,dc=example,dc=com":
Initializing database for realm 'EXAMPLE.COM'
You will be prompted for the database Master Password.
It is important that you NOT FORGET this password.
Enter KDC database master key:
Re-enter KDC database master key to verify:
```

- Create a stash of the password used to bind to the LDAP server. Run it once for each `ldap_kdc_dn` and `ldap_kadmin_dn`:

```
sudo kdb5_ldap_util -D cn=admin,dc=example,dc=com stashesrvpw -f /etc/krb5kdc/service.keyfile uid=kdc-
service,dc=example,dc=com
sudo kdb5_ldap_util -D cn=admin,dc=example,dc=com stashesrvpw -f /etc/krb5kdc/service.keyfile uid=kadmin-
service,dc=example,dc=com
```

#### Note

The `/etc/krb5kdc/service.keyfile` file now contains clear text versions of the passwords used by the KDC to contact the LDAP server!

- Create a `/etc/krb5kdc/kadm5.acl` file for the admin server, if you haven't already:

```
*/admin@EXAMPLE.COM *
```

- Start the Kerberos KDC and admin server:

```
sudo systemctl start krb5-kdc.service krb5-admin-server.service
```

You can now add Kerberos principals to the LDAP database, and they will be copied to any other LDAP servers configured for replication. To add a principal using the `kadmin.local` utility enter:

```
$ sudo kadmin.local
Authenticating as principal root/admin@EXAMPLE.COM with password.
kadmin.local: addprinc ubuntu
WARNING: no policy specified for ubuntu@EXAMPLE.COM; defaulting to no policy
Enter password for principal "ubuntu@EXAMPLE.COM":
Re-enter password for principal "ubuntu@EXAMPLE.COM":
Principal "ubuntu@EXAMPLE.COM" created.
```

kadmin.local:

The above will create an `ubuntu` *principal* with a `dn` of `krbPrincipalName=ubuntu@EXAMPLE.COM,cn=EXAMPLE.COM,cn=krbContainer,dc=example,dc=com`. Let's say, however, that you already have an user in your directory, and it's in `uid=testuser1,ou=People,dc=example,dc=com`, how to add the kerberos attributes to it? You use the `-x` parameter to specify the location. For the `ldap_kadmin_dn` to be able to write to it, we first need to update the ACLs:

```
$ sudo ldapmodify -Q -Y EXTERNAL -H ldapi:/// <<EOF
dn: olcDatabase={1}mdb,cn=config
add: olcAccess
olcAccess: {4}to dn.subtree="ou=People,dc=example,dc=com"
 by dn.exact="uid=kdc-service,dc=example,dc=com" read
 by dn.exact="uid=kadmin-service,dc=example,dc=com" write
 by * break
EOF
```

And now we can specify the new location:

```
$ sudo kadmin.local
Authenticating as principal root/admin@EXAMPLE.COM with password.
kadmin.local: addprinc -x dn=uid=testuser1,ou=People,dc=example,dc=com testuser1
WARNING: no policy specified for testuser1@EXAMPLE.COM; defaulting to no policy
Enter password for principal "testuser1@EXAMPLE.COM":
Re-enter password for principal "testuser1@EXAMPLE.COM":
Principal "testuser1@EXAMPLE.COM" created.
```

Since the specified `dn` already exists, `kadmin.local` will just add the required kerberos attributes to this existing entry. If it didn't exist, it would be created from scratch, with just the kerberos attributes, like what happened with the `ubuntu` example above, but in the specified location.

### Note

The `ldap_kadmin_dn` DN (`uid=kadmin-service` in our example) does not have write access to the location specified by the `-x` parameter, you will get an `Insufficient access` error.

Both places are visible for `kinit`, since, when the realm was created with `kdb5_ldap_util`, the default value for the search scope and base were taken: `subtree`, and `dc=example,dc=com`.

## Secondary KDC Configuration (LDAP)

The setup of the secondary KDC (and its OpenLDAP replica) is very similar. Once you have the OpenLDAP replication setup, repeat these steps on the secondary:

- install `krb5-kdc-ldap`, `ldap-utils`. Do not install `krb5-admin-server`.
- load the kerberos schema using `schema2ldif`
- add the index for `krbPrincipalName`
- add the ACLs
- configure `krb5.conf` in the same way, initially. If you want and if you configured SSL properly, you can add `ldaps://kdc01.example.com` to the `ldap_servers` list after `ldapi:///`, so that the Secondary KDC can have two LDAP backends at its disposal
- **DO NOT** run `kdb5_ldap_util`. There is no need to create the database since it's being replicated from the Primary
- copy over the following files from the Primary KDC and place them in the same location on the Secondary:
  - `/etc/krb5kdc/stash`
  - `/etc/krb5kdc/service.keyfile`
- start the KDC: `sudo systemctl start krb5-kdc.service`

## Resources

- [Configuring Kerberos with OpenLDAP back-end](#)
- [MIT Kerberos backend types](#)

SSSD stands for System Security Services Daemon and it's actually a collection of daemons that handle authentication, authorization, and user and group information from a variety of network sources. At its core it has support for:

- Active Directory
- LDAP
- Kerberos



SSSD provides PAM and NSS modules to integrate these remote sources into your system and allow remote users to login and be recognized as valid users, including group membership. To allow for disconnected operation, SSSD also can also cache this information, so that users can continue to login in the event of a network failure, or other problem of the same sort.

This guide will focus on the most common scenarios where SSSD is deployed.

## References

- Upstream project: <https://sssd.io/>

This section describes the use of sssd to authenticate user logins against an Active Directory via using sssd's "ad" provider. At the end, Active Directory users will be able to login on the host using their AD credentials. Group membership will also be maintained.

## Prerequisites, Assumptions, and Requirements

- This guide does not explain Active Directory, how it works, how to set one up, or how to maintain it.
- This guide assumes that a working Active Directory domain is already configured and you have access to the credentials to join a machine to that domain.
- The domain controller is acting as an authoritative DNS server for the domain.
- The domain controller is the primary DNS resolver (check with `systemd-resolve --status`)
- System time is correct and in sync, maintained via a service like *chrony* or *ntp*
- The domain used in this example is `ad1.example.com` .

## Software Installation

Install the following packages:

```
sudo apt install sssd-ad sssd-tools realmd adcli
```

## Join the domain

We will use the `realm` command, from the `realmd` package, to join the domain and create the sssd configuration.

Let's verify the domain is discoverable via DNS:

```
$ sudo realm -v discover ad1.example.com
* Resolving: _ldap._tcp.ad1.example.com
* Performing LDAP DSE lookup on: 10.51.0.5
* Successfully discovered: ad1.example.com
ad1.example.com
type: kerberos
realm-name: AD1.EXAMPLE.COM
domain-name: ad1.example.com
configured: no
server-software: active-directory
client-software: sssd
required-package: sssd-tools
required-package: sssd
required-package: libnss-sss
required-package: libpam-sss
required-package: adcli
required-package: samba-common-bin
```

This performs several checks and determines the best software stack to use with sssd. sssd can install the missing packages via *packagekit*, but we installed them already previously.

Now let's join the domain:

```
$ sudo realm join ad1.example.com
Password for Administrator:
```

That was quite uneventful. If you want to see what it was doing, pass the `-v` option:

```

$ sudo realm join -v ad1.example.com
* Resolving: _ldap._tcp.ad1.example.com
* Performing LDAP DSE lookup on: 10.51.0.5
* Successfully discovered: ad1.example.com
Password for Administrator:
* Unconditionally checking packages
* Resolving required packages
* LANG=C /usr/sbin/adcli join --verbose --domain ad1.example.com --domain-realm AD1.EXAMPLE.COM --domain-
controller 10.51.0.5 --login-type user --login-user Administrator --stdin-password
* Using domain name: ad1.example.com
* Calculated computer account name from fqdn: AD-CLIENT
* Using domain realm: ad1.example.com
* Sending NetLogon ping to domain controller: 10.51.0.5
* Received NetLogon info from: SERVER1.ad1.example.com
* Wrote out krb5.conf snippet to /var/cache/realmd/adcli-krb5-hUfTUg/krb5.d/adcli-krb5-conf-hv2kzi
* Authenticated as user: Administrator@AD1.EXAMPLE.COM
* Looked up short domain name: AD1
* Looked up domain SID: S-1-5-21-2660147319-831819607-3409034899
* Using fully qualified name: ad-client.ad1.example.com
* Using domain name: ad1.example.com
* Using computer account name: AD-CLIENT
* Using domain realm: ad1.example.com
* Calculated computer account name from fqdn: AD-CLIENT
* Generated 120 character computer password
* Using keytab: FILE:/etc/krb5.keytab
* Found computer account for AD-CLIENT$ at: CN=AD-CLIENT,CN=Computers,DC=ad1,DC=example,DC=com
* Sending NetLogon ping to domain controller: 10.51.0.5
* Received NetLogon info from: SERVER1.ad1.example.com
* Set computer password
* Retrieved kvno '3' for computer account in directory: CN=AD-CLIENT,CN=Computers,DC=ad1,DC=example,DC=com
* Checking RestrictedKrbHost/ad-client.ad1.example.com
* Added RestrictedKrbHost/ad-client.ad1.example.com
* Checking RestrictedKrbHost/AD-CLIENT
* Added RestrictedKrbHost/AD-CLIENT
* Checking host/ad-client.ad1.example.com
* Added host/ad-client.ad1.example.com
* Checking host/AD-CLIENT
* Added host/AD-CLIENT
* Discovered which keytab salt to use
* Added the entries to the keytab: AD-CLIENT$@AD1.EXAMPLE.COM: FILE:/etc/krb5.keytab
* Added the entries to the keytab: host/AD-CLIENT@AD1.EXAMPLE.COM: FILE:/etc/krb5.keytab
* Added the entries to the keytab: host/ad-client.ad1.example.com@AD1.EXAMPLE.COM: FILE:/etc/krb5.keytab
* Added the entries to the keytab: RestrictedKrbHost/AD-CLIENT@AD1.EXAMPLE.COM: FILE:/etc/krb5.keytab
* Added the entries to the keytab: RestrictedKrbHost/ad-client.ad1.example.com@AD1.EXAMPLE.COM: FILE:/etc/krb5.keytab
* /usr/sbin/update-rc.d sssd enable
* /usr/sbin/service sssd restart
* Successfully enrolled machine in realm

```

By default, *realm* will use the *Administrator* account of the domain to request the join. If you need to use another account, pass it to the tool with the `-U` option.

Another popular way of joining a domain is using an *OTP*, or *One Time Password*, token. For that, use the `--one-time-password` option.

## SSSD Configuration

The *realm* tool already took care of creating an sssd configuration, adding the pam and nss modules, and starting the necessary services.

Let's take a look at `/etc/sss/sss.conf`:

```

[sss]
domains = ad1.example.com
config_file_version = 2
services = nss, pam

```

```
[domain/ad1.example.com]
default_shell = /bin/bash
krb5_store_password_if_offline = True
cache_credentials = True
krb5_realm = AD1.EXAMPLE.COM
realmd_tags = manages-system joined-with-adcli
id_provider = ad
fallback_homedir = /home/%u@%d
ad_domain = ad1.example.com
use_fully_qualified_names = True
ldap_id_mapping = True
access_provider = ad
```

### Note

Something very important to remember is that this file must have permissions *0600* and ownership *root:root*, or else sssd won't start!

Let's highlight a few things from this config:

- *cache\_credentials*: this allows logins when the AD server is unreachable
- home directory: it's by default */home/<user>@<domain>*. For example, the AD user *john* will have a home directory of */home/john@ad1.example.com*
- *use\_fully\_qualified\_names*: users will be of the form *user@domain*, not just *user*. This should only be changed if you are certain no other domains will ever join the AD forest, via one of the several possible trust relationships

## Automatic home directory creation

What the *realm* tool didn't do for us is setup *pam\_mkhomedir*, so that network users can get a home directory when they login. This remaining step can be done by running the following command:

```
sudo pam-auth-update --enable mkhomedir
```

## Checks

You should now be able to fetch information about AD users. In this example, *John Smith* is an AD user:

```
$ getent passwd john@ad1.example.com
john@ad1.example.com:*:1725801106:1725800513:John Smith:/home/john@ad1.example.com:/bin/bash
```

Let's see his groups:

```
$ groups john@ad1.example.com
john@ad1.example.com : domain users@ad1.example.com engineering@ad1.example.com
```

### Note

If you just changed the group membership of a user, it may be a while before sssd notices due to caching.

Finally, how about we try a login:

```
$ sudo login
ad-client login: john@ad1.example.com
Password:
Welcome to Ubuntu 20.04 LTS (GNU/Linux 5.4.0-24-generic x86_64)
...
Creating directory '/home/john@ad1.example.com'.
john@ad1.example.com@ad-client:~$
```

Notice how the home directory was automatically created.

You can also use *ssh*, but note that the command will look a bit funny because of the multiple *@* signs:

```
$ ssh john@ad1.example.com@10.51.0.11
Welcome to Ubuntu 20.04 LTS (GNU/Linux 5.4.0-24-generic x86_64)
(...)
Last login: Thu Apr 16 21:22:55 2020
john@ad1.example.com@ad-client:~$
```

## Note

In the ssh example, public key authentication was used, so no password was required. Remember that ssh password authentication is by default disabled in `/etc/ssh/sshd_config`.

## Kerberos Tickets

If you install `krb5-user`, your AD users will also get a kerberos ticket upon logging in:

```
john@ad1.example.com@ad-client:~$ klist
Ticket cache: FILE:/tmp/krb5cc_1725801106_9UxVIz
Default principal: john@AD1.EXAMPLE.COM
```

```
Valid starting Expires Service principal
04/16/20 21:32:12 04/17/20 07:32:12 krbtgt/AD1.EXAMPLE.COM@AD1.EXAMPLE.COM
 renew until 04/17/20 21:32:12
```

## Note

`realm` also configured `/etc/krb5.conf` for you, so there should be no further configuration prompts when installing `krb5-user`

Let's test with `smbclient` using kerberos authentication to list the shares of the domain controller:

```
john@ad1.example.com@ad-client:~$ smbclient -k -L server1.ad1.example.com
```

```
Sharename Type Comment

ADMIN$ Disk Remote Admin
C$ Disk Default share
IPC$ IPC Remote IPC
NETLOGON Disk Logon server share
SYSVOL Disk Logon server share
SMB1 disabled -- no workgroup available
```

Notice how we now have a ticket for the `cifs` service, which was used for the share list above:

```
john@ad1.example.com@ad-client:~$ klist
Ticket cache: FILE:/tmp/krb5cc_1725801106_9UxVIz
Default principal: john@AD1.EXAMPLE.COM
```

```
Valid starting Expires Service principal
04/16/20 21:32:12 04/17/20 07:32:12 krbtgt/AD1.EXAMPLE.COM@AD1.EXAMPLE.COM
 renew until 04/17/20 21:32:12
04/16/20 21:32:21 04/17/20 07:32:12 cifs/server1.ad1.example.com@AD1.EXAMPLE.COM
```

## Desktop Ubuntu Authentication

The desktop login only shows local users in the list to pick from, and that's on purpose.

To login with an Active Directory user for the first time, follow these steps:

- click on the “Not listed?” option:

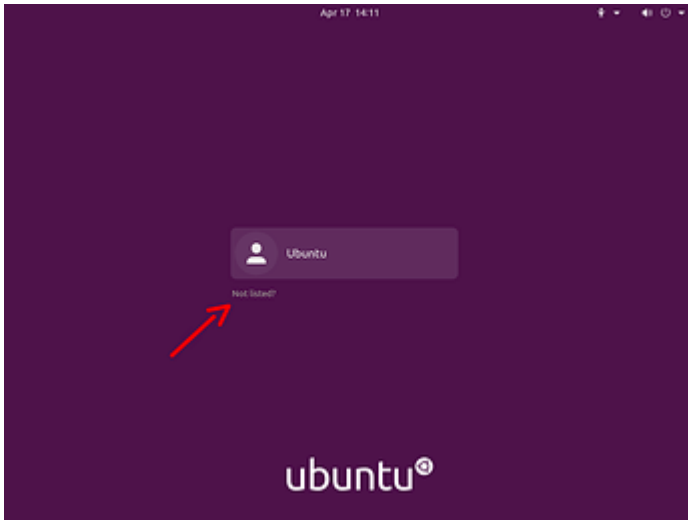

click-not-listed1024×768 14.5 KB

- type in the login name followed by the password:

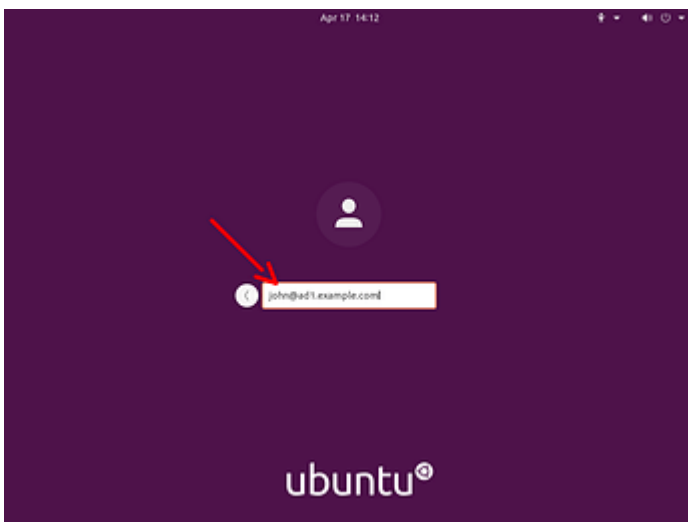

type-in-username1024×768 16.3 KB

- the next time you login, the AD user will be listed as if it was a local user:

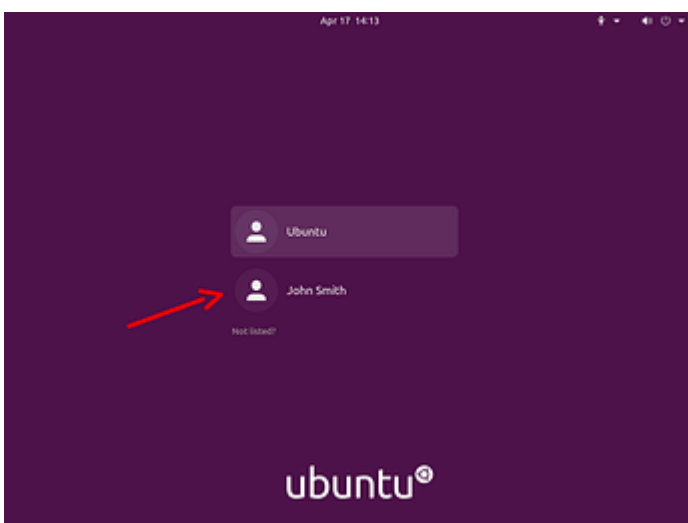

next-time1024×768 16.1 KB

## Known Issues

When logging in on a system joined with an Active Directory domain, `sssd` (the package responsible for this integration) will try to apply Group Policies by default. There are cases where if a specific policy is missing, the login will be

denied.

This is being tracked in [bug #1934997](#). Until the fix becomes available, please see [comment #5](#) in that bug report for existing workarounds.

## Resources

- [GitHub SSSD Project](#)
- [Active Directory DNS Zone Entries](#)

SSSD can also use LDAP for authentication, authorization, and user/group information. In this section we will configure a host to authenticate users from an OpenLDAP directory.

## Prerequisites, Assumptions, and Requirements

For this setup, we need:

- an existing OpenLDAP server with SSL enabled and using the RFC2307 schema for users and groups
- a client host where we will install the necessary tools and login as a user from the LDAP server

## Software Installation

Install the following packages:

```
sudo apt install sssd-ldap ldap-utils
```

## SSSD Configuration

Create the `/etc/sss/sss.conf` configuration file, with permissions `0600` and ownership `root:root`, and this content:

```
[sss]
config_file_version = 2
domains = example.com

[domain/example.com]
id_provider = ldap
auth_provider = ldap
ldap_uri = ldap://ldap01.example.com
cache_credentials = True
ldap_search_base = dc=example,dc=com
```

Make sure to start the `sss` service:

```
sudo systemctl start sss.service
```

### Note

`sss` will use `START_TLS` by default for authentication requests against the LDAP server (the `auth_provider`), but not for the `id_provider`. If you want to also enable `START_TLS` for the `id_provider`, specify `ldap_id_use_start_tls = true`.

## Automatic home directory creation

To enable automatic home directory creation, run the following command:

```
sudo pam-auth-update --enable mkhomedir
```

## Check SSL setup on the client

The client must be able to use `START_TLS` when connecting to the LDAP server, with full certificate checking. This means:

- the client host knows and trusts the CA that signed the LDAP server certificate
- the server certificate was issued for the correct host (`ldap01.example.com` in this guide)
- the time is correct on all hosts performing the TLS connection
- and, of course, that neither certificate (CA or server's) expired

If using a custom CA, an easy way to have a host trust it is to place it in `/usr/local/share/ca-certificates/` with a `.crt` extension and run `sudo update-ca-certificates`.

Alternatively, you can edit `/etc/ldap/ldap.conf` and point `TLS_CACERT` to the CA public key file.

## Note

You may have to restart `sssd` after these changes: `sudo systemctl restart sssd`

Once that is all done, check that you can connect to the LDAP server using verified SSL connections:

```
$ ldapwhoami -x -ZZ -H ldap://ldap01.example.com
anonymous
```

and for `ldaps` (if enabled in `/etc/default/slapd`):

```
$ ldapwhoami -x -H ldaps://ldap01.example.com
```

The `-ZZ` parameter tells the tool to use `START_TLS`, and that it must not fail. If you have LDAP logging enabled on the server, it will show something like this:

```
slapd[779]: conn=1032 op=0 STARTTLS
slapd[779]: conn=1032 op=0 RESULT oid= err=0 text=
slapd[779]: conn=1032 fd=15 TLS established tls_ssf=256 ssf=256
slapd[779]: conn=1032 op=1 BIND dn="" method=128
slapd[779]: conn=1032 op=1 RESULT tag=97 err=0 text=
slapd[779]: conn=1032 op=2 EXT oid=1.3.6.1.4.1.4203.1.11.3
slapd[779]: conn=1032 op=2 WHOAMI
slapd[779]: conn=1032 op=2 RESULT oid= err=0 text=
```

`START_TLS` with `err=0` and `TLS established` is what we want to see there, and, of course, the `WHOAMI` extended operation.

## Final verification

In this example, the LDAP server has the following user and group entry we are going to use for testing:

```
dn: uid=john,ou=People,dc=example,dc=com
uid: john
objectClass: inetOrgPerson
objectClass: posixAccount
cn: John Smith
sn: Smith
givenName: John
mail: john@example.com
userPassword: johnsecret
uidNumber: 10001
gidNumber: 10001
loginShell: /bin/bash
homeDirectory: /home/john
```

```
dn: cn=john,ou=Group,dc=example,dc=com
cn: john
objectClass: posixGroup
gidNumber: 10001
memberUid: john
```

```
dn: cn=Engineering,ou=Group,dc=example,dc=com
cn: Engineering
objectClass: posixGroup
gidNumber: 10100
memberUid: john
```

The user `john` should be known to the system:

```
ubuntu@ldap-client:~$ getent passwd john
john:*:10001:10001:John Smith:/home/john:/bin/bash
```

```
ubuntu@ldap-client:~$ id john
uid=10001(john) gid=10001(john) groups=10001(john),10100(Engineering)
```

And we should be able to authenticate as `john`:

```
ubuntu@ldap-client:~$ sudo login
ldap-client login: john
```

Password:

```
Welcome to Ubuntu Focal Fossa (development branch) (GNU/Linux 5.4.0-24-generic x86_64)
(...)
Creating directory '/home/john'.
john@ldap-client:~$
```

Finally, we can mix it all together in a setup that is very similar to Active Directory in terms of the technologies used: use LDAP for users and groups, and Kerberos for authentication.

## Prerequisites, Assumptions, and Requirements

For this setup, we will need:

- an existing OpenLDAP server using the RFC2307 schema for users and groups. SSL support is recommended, but not strictly necessary because authentication in this setup is being done via Kerberos, and not LDAP.
- a Kerberos server. It doesn't have to be using the OpenLDAP backend
- a client host where we will install and configure SSSD

## Software Installation

On the client host, install the following packages:

```
sudo apt install sssd-ldap sssd-krb5 ldap-utils krb5-user
```

You may be asked about the default Kerberos realm. For this guide, we are using `EXAMPLE.COM`.

At this point, you should already be able to obtain tickets from your Kerberos server, assuming DNS records point at it like explained elsewhere in this guide:

```
$ kinit ubuntu
Password for ubuntu@EXAMPLE.COM:

ubuntu@ldap-krb-client:~$ klist
Ticket cache: FILE:/tmp/krb5cc_1000
Default principal: ubuntu@EXAMPLE.COM
```

```
Valid starting Expires Service principal
04/17/20 19:51:06 04/18/20 05:51:06 krbtgt/EXAMPLE.COM@EXAMPLE.COM
 renew until 04/18/20 19:51:05
```

But we want to be able to login as an LDAP user, authenticated via Kerberos. Let's continue with the configuration.

## SSSD Configuration

Create the `/etc/sss/sss.conf` configuration file, with permissions `0600` and ownership `root:root`, and this content:

```
[sss]
config_file_version = 2
domains = example.com

[domain/example.com]
id_provider = ldap
ldap_uri = ldap://ldap01.example.com
ldap_search_base = dc=example,dc=com
auth_provider = krb5
krb5_server = kdc01.example.com,kdc02.example.com
krb5_kpasswd = kdc01.example.com
krb5_realm = EXAMPLE.COM
cache_credentials = True
```

This example uses two KDCs, which made it necessary to also specify the `krb5_kpasswd` server because the second KDC is a replica and is not running the admin server.

Start the `sss` service:

```
sudo systemctl start sssd.service
```



## Automatic home directory creation

To enable automatic home directory creation, run the following command:

```
sudo pam-auth-update --enable mkhomedir
```

## Final verification

In this example, the LDAP server has the following user and group entry we are going to use for testing:

```
dn: uid=john,ou=People,dc=example,dc=com
uid: john
objectClass: inetOrgPerson
objectClass: posixAccount
cn: John Smith
sn: Smith
givenName: John
mail: john@example.com
uidNumber: 10001
gidNumber: 10001
loginShell: /bin/bash
homeDirectory: /home/john
```

```
dn: cn=john,ou=Group,dc=example,dc=com
cn: john
objectClass: posixGroup
gidNumber: 10001
memberUid: john
```

```
dn: cn=Engineering,ou=Group,dc=example,dc=com
cn: Engineering
objectClass: posixGroup
gidNumber: 10100
memberUid: john
```

Note how the *john* user has no *userPassword* attribute.

The user *john* should be known to the system:

```
ubuntu@ldap-client:~$ getent passwd john
john:*:10001:10001:John Smith:/home/john:/bin/bash
```

```
ubuntu@ldap-client:~$ id john
uid=10001(john) gid=10001(john) groups=10001(john),10100(Engineering)
```

Let's try a login as this user:

```
ubuntu@ldap-krb-client:~$ sudo login
ldap-krb-client login: john
Password:
Welcome to Ubuntu 20.04 LTS (GNU/Linux 5.4.0-24-generic x86_64)
(...)
Creating directory '/home/john'.
```

```
john@ldap-krb-client:~$ klist
Ticket cache: FILE:/tmp/krb5cc_10001_B0rxWr
Default principal: john@EXAMPLE.COM
```

```
Valid starting Expires Service principal
04/17/20 20:29:50 04/18/20 06:29:50 krbtgt/EXAMPLE.COM@EXAMPLE.COM
renew until 04/18/20 20:29:50
john@ldap-krb-client:~$
```

We logged in using the kerberos password, and user/group information from the LDAP server.

## SSSD and KDC spoofing

When using SSSD to manage kerberos logins on a Linux host, there is an attack scenario you should be aware of: KDC spoofing.

The objective of the attacker is to login on a workstation that is using Kerberos authentication. Let's say he knows john is a valid user on that machine.

The attacker first deploys a rogue KDC server in the network, and creates the john principal there with a password of his choosing. What he has to do now is to have his rogue KDC respond to the login request from the workstation, before (or instead of) the real KDC. If the workstation isn't authenticating the KDC, it will accept the reply from the rogue server and let john in.

There is a configuration parameter that can be set to protect the workstation from this attack. It will have SSSD authenticate the KDC, and block the login if the KDC cannot be verified. This option is called `krb5_validate`, and it's false by default.

To enable it, edit `/etc/sss/sss.conf` and add this line to the domain section:

```
[sss]
config_file_version = 2
domains = example.com

[domain/example.com]
id_provider = ldap
...
krb5_validate = True
```

The second step is to create a host principal on the KDC for this workstation. This is how the KDC's authenticity is verified. It's like a "machine account", with a shared secret that the attacker cannot control and replicate in his rogue KDC...The host principal has the format `host/<fqdn>@REALM`.

After the host principal is created, its keytab needs to be stored on the workstation. This two step process can be easily done on the workstation itself via `kadmin` (not `kadmin.local`) to contact the KDC remotely:

```
$ sudo kadmin -p ubuntu/admin
kadmin: addprinc -randkey host/ldap-krb-client.example.com@EXAMPLE.COM
WARNING: no policy specified for host/ldap-krb-client.example.com@EXAMPLE.COM; defaulting to no policy
Principal "host/ldap-krb-client.example.com@EXAMPLE.COM" created.

kadmin: ktadd -k /etc/krb5.keytab host/ldap-krb-client.example.com
Entry for principal host/ldap-krb-client.example.com with kvno 6, encryption type aes256-cts-hmac-sha1-96 added to keytab WRFILE:/etc/krb5.keytab.
Entry for principal host/ldap-krb-client.example.com with kvno 6, encryption type aes128-cts-hmac-sha1-96 added to keytab WRFILE:/etc/krb5.keytab.
```

Then exit the tool and make sure the permissions on the keytab file are tight:

```
sudo chmod 0600 /etc/krb5.keytab
sudo chown root:root /etc/krb5.keytab
```

You can also do it on the KDC itself using `kadmin.local`, but you will have to store the keytab temporarily in another file and securely copy it over to the workstation.

Once these steps are complete, you can restart sssd on the workstation and perform the login. If the rogue KDC picks the attempt up and replies, it will fail the host verification. With debugging we can see that happening on the workstation:

```
==> /var/log/sss/krb5_child.log <==
(Mon Apr 20 19:43:58 2020) [[sss[krb5_child[2102]]] [validate_tgt] (0x0020): TGT failed verification using key for [host/ldap-krb-client.example.com@EXAMPLE.COM].
(Mon Apr 20 19:43:58 2020) [[sss[krb5_child[2102]]] [get_and_save_tgt] (0x0020): 1741: [-1765328377][Server host/ldap-krb-client.example.com@EXAMPLE.COM not found in Kerberos database]
```

And the login is denied. If the real KDC picks it up, however, the host verification succeeds:

```
==> /var/log/sss/krb5_child.log <==
(Mon Apr 20 19:46:22 2020) [[sss[krb5_child[2268]]] [validate_tgt] (0x0400): TGT verified using key for [host/ldap-krb-client.example.com@EXAMPLE.COM].
```

And the login is accepted.

Here are some tips to help troubleshoot sssd.

## debug\_level

The debug level of sssd can be changed on-the-fly via `sssctl`, from the `sssd-tools` package:

```
sudo apt install sssd-tools
sssctl debug-level <new-level>
```

Or change add it to the config file and restart sssd:

```
[sssd]
config_file_version = 2
domains = example.com

[domain/example.com]
debug_level = 6
...
```

Either will yield more logs in `/var/log/sss/*.log` and can help identify what is going on. The `sssctl` approach has the clear advantage of not having to restart the service.

## Caching

Caching is useful to speed things up, but it can get in the way big time when troubleshooting. It's useful to be able to remove the cache while chasing down a problem. This can also be done with the `sssctl` tool from the `sssd-tools` package.

You can either remove the whole cache:

```
sssctl cache-remove
Creating backup of local data...
SSSD backup of local data already exists, override? (yes/no) [no] yes
Removing cache files...
SSSD= needs to be running. Start SSSD now? (yes/no) [yes] yes
```

Or just one element:

```
sssctl cache-expire -u john
```

Or expire everything:

```
sssctl cache-expire -E
```

## DNS

Kerberos is quite sensitive to DNS issues. If you suspect something related to DNS, here are two suggestions:

### FQDN hostname

Make sure `hostname -f` returns a fully qualified domain name. Set it in `/etc/hostname` if necessary, and use `sudo hostnamectl set-hostname <fqdn>` to set it at runtime.

### Reverse name lookup

You can try disabling a default reverse name lookup that the `krb5` libraries do, by editing (or creating) `/etc/krb5.conf` and setting `rdns = false` in the `[libdefaults]` section:

```
[libdefaults]
rdns = false
```

WireGuard is a simple, fast and modern VPN implementation, widely deployed and cross-platform.

VPNs have traditionally been hard to understand, configure and deploy. WireGuard removed most of that complexity by focusing on its single task, and leaving out things like key distribution and pushed configurations. You get a network interface which encrypts and verifies the traffic, and the remaining tasks like setting up addresses, routing, etc, are left to the usual system tools like `ip-route(8)` and `ip-address(8)`.

Setting up the cryptographic keys is very much similar to configuring `ssh` for key based authentication: each side of the connection has its own private and public key, and the peers' public key, and this is enough to start encrypting and verifying the exchanged traffic.

For more details on how WireGuard works, and information on its availability in other platforms, please see the references section.

## WireGuard Concepts

It helps to think of WireGuard primarily as a network interface, like any other. It will have the usual attributes, like IP address, CIDR, and there will be some routing associated with it. But it also has WireGuard specific attributes, which handle the VPN part of things.

All of this can be configured via different tools. WireGuard itself ships its own tools in the userspace package `wireguard-tools`: `wg(8)` and `wg-quick(8)`. But these are not strictly needed: any userspace with the right privileges and kernel calls can configure a WireGuard interface. For example, `systemd-networkd` and `network-manager` can do it on their own, without the WireGuard userspace utilities.

Important attributes of a WireGuard interface are:

- *private key*: together with the corresponding public key, they are used to authenticate and encrypt data. This is generated with the `wg genkey` command.
- *listen port*: the UDP port that WireGuard will be listening to for incoming traffic.
- List of *peers*, each one with:
  - *public key*: the public counterpart of the private key. Generated from the private key of that peer, using the `wg pubkey` command.
  - *endpoint*: where to send the encrypted traffic to. This is optional, but at least one of the corresponding peers must have it to bootstrap the connection.
  - *allowed IPs*: list of inner tunnel destination networks or addresses for this peer when sending traffic, or, when receiving traffic, which source networks or addresses are allowed to send traffic to us.

### NOTE

Cryptography is not simple. When we say that, for example, a private key is used to decrypt or sign traffic, and a public key is used to encrypt or verify the authenticity of traffic, this is a simplification and is hiding a lot of important details. WireGuard has a detailed explanation of its protocols and cryptography handling in their website, at <https://www.wireguard.com/protocol/>

These parameters can be set with the low-level `wg(8)` tool, directly via the command line or with a configuration file. This tool, however, doesn't handle the non-WireGuard settings of the interface. It won't assign an IP address to it, for example, nor setup routing. For this reason, it's more common to use `wg-quick(8)`.

`wg-quick(8)` will handle the lifecycle of the WireGuard interface. It can bring it up or down, setup routing, execute arbitrary commands before or after the interface is up, and more. It augments the configuration file that `wg(8)` can use, with its own extra settings, which is important to keep in mind when feeding that file to `wg(8)`, as it will contain settings `wg(8)` knows nothing about.

The `wg-quick(8)` configuration file can have an arbitrary name, and can even be placed anywhere on the system, but the best practice is:

- Place the file in `/etc/wireguard`.
- Name it after the interface it controls.

For example, a file called `/etc/wireguard/wg0.conf` will have the needed configurations setting for a WireGuard network interface called `wg0`. By following this practice, you get the benefit of being able to call `wg-quick` with just the interface name:

```
$ sudo wg-quick up wg0
```

And that will bring the `wg0` interface up, give it an IP address, setup routing, and configure the WireGuard specific parameters for it to work. This interface is usually called `wg0`, but can have any valid network interface name, like `office` (it doesn't need an index number after the name), `home1`, etc. It can help to give it a meaningful name if you plan to connect to multiple peers.

Let's go over an example of such a configuration file:

```
[Interface]
PrivateKey = eJdSgoS7BZ/uWkuSREN+vhCJPPr3M3U1B3v1Su/amWk=
ListenPort = 51000
Address = 10.10.11.10/24

[Peer]
office
PublicKey = xeWmdxiLjgebpcItFlouRo0ntrgFekquRJJZQ0+vsQVs=
```

```
Endpoint = wg.example.com:51000 # fake endpoint, just an example
```

```
AllowedIPs = 10.10.11.0/24, 10.10.10.0/24
```

In the [Interface] section:

- **Address:** this is the IP address, and CIDR, that the WireGuard interface will be setup with.
- **ListenPort:** the UDP port WireGuard will use for traffic (listening and sending).
- **PrivateKey:** the secret key used to decrypt traffic destined to this interface.

The *peers* list, each one in its own [Peer] section (example above has just one), comes next:

- **PublicKey:** the key that will be used to encrypt traffic to this peer.
- **Endpoint:** where to send encrypted traffic to.
- **AllowedIPs:** when sending traffic, this is the list of target addresses that identify this peer. When receiving traffic, it's the list of addresses that are allowed to be the source of the traffic.

To generate the keypairs for each peer, the `wg(8)` command is used:

```
$ umask 077
$ wg genkey > wg0.key
$ wg pubkey < wg0.key > wg0.pub
```

And then the contents of `wg0.key` and `wg0.pub` can be used in the configuration file.

This is what it looks like when this interface is brought up by `wg-quick(8)`:

```
$ sudo wg-quick up wg0
[#] ip link add wg0 type wireguard
[#] wg setconf wg0 /dev/fd/63
[#] ip -4 address add 10.10.11.10/24 dev wg0
[#] ip link set mtu 1420 up dev wg0
[#] ip -4 route add 10.10.10.0/24 dev wg0
```

This is what `wg-quick(8)` did for us:

- Created the WireGuard `wg0` interface.
- Configured it with the data from the configuration file.
- Added the IP/CIDR from the **Address** field to the `wg0` interface.
- Calculated a proper MTU (which can be overridden in the config if needed)
- Added a route for **AllowedIPs**.

Note that in this example **AllowedIPs** is a list of two CIDR network blocks, but `wg-quick(8)` only added a route for `10.10.10.0/24` and skipped `10.10.11.0/24`. That's because the **Address** was already specified as a `/24` one. Had we specified the address as `10.10.11.10/32` instead, then `wg-quick(8)` would have added a route for `10.10.11.0/24` explicitly.

To better understand how **AllowedIPs** work, let's go through a quick example.

Let's say this system wants to send traffic to `10.10.10.201/24`. There is a route for it which says to use the `wg0` interface for that:

```
$ ip route get 10.10.10.201
10.10.10.201 dev wg0 src 10.10.11.10 uid 1000
 cache
```

Since `wg0` is a WireGuard interface, it will consult its configuration to see if any peer has that target address in the **AllowedIPs** list. Turns out one peer has it, in which case the traffic will:

- a) Be authenticated as us, and encrypted for that peer.
- b) Sent away via the configured **Endpoint**.

Now let's picture the reverse. This system received traffic on the **ListenPort** UDP port. If it can be decrypted, and verified as having come from one of the listed peers using its respective public key, and if the source IP matches the corresponding **AllowedIPs** list, then the traffic is accepted.

What if there is no **Endpoint**? Well, to bootstrap the VPN, at least one of the peers must have an **Endpoint**, or else it won't know where to send the traffic to, and you will get an error saying "Destination address required" (see the troubleshooting section for details).

But once the peers know each other, the one that didn't have an **Endpoint** setting in the interface will remember where the traffic came from, and use that address as the current endpoint. This has a very nice side effect of automatically tracking the so called "road warrior" peer, which keeps changing its IP. That is very common with laptops that keep being suspended and awakened in a new network, and then try to establish the VPN again from that new address.

## Peers

You will notice that the term “peers” is used preferably to “server” or “client”. Other terms used in some VPN documentation are “left” and “right”, which is already starting to convey that the difference between a “server” and a “client” is a bit blurry. It only matters, if at all, at the start of the traffic exchange: who sends the first packet of data. In that sense, “servers” expect to sit idle and wait for connections to be initiated to them, and “clients” are the initiators. For example, a laptop on a public cafe initiating a connection to the company VPN peer. The laptop needs to know the address of that peer, because it’s initiating the exchange. But the “server” doesn’t need to know the IP of the laptop beforehand.

On a site to site VPN, however, when two separate networks are connected through the tunnel, who is the server, and who is the client? Both, so it’s best to call them “peers” instead.

## Putting it all together

Key takeaways from this introduction:

- Each peer participating in the WireGuard VPN has a private key and a public key.
- `AllowedIPs` is used as a routing key when sending traffic, and as an ACL when receiving traffic.
- To establish a VPN with a remote peer, you need its public key. Likewise, the remote peer will need your public key.
- At least one of the peers needs an `Endpoint` configured in order to be able to initiate the VPN.

To help better understand these and other concepts, we will create some WireGuard VPNs in the next sections, illustrating some common setups.

### NOTE

Throughout this guide, we will sometimes mention a VPN “connection”. This is technically false, as WireGuard uses UDP and there is no persistent connection. The term is used just to facilitate understanding, and means that the peers in the examples know each other and have completed a handshake already.

## References

- See the [WireGuard website](#) for more detailed information.
- The [WireGuard Quickstart](#) has a good introduction and demo.
- [wg\(8\)](#) and [wg-quick\(8\)](#) manual pages.
- [Detailed explanation](#) of the algorithms used by WireGuard.

To help understand the WireGuard concepts, we will show some practical setups that hopefully match many scenarios out there.

This is probably the most common setup for a VPN: connecting a single system to a remote site, and getting access to the remote network “as if you were there”.

Where to place the remote WireGuard endpoint in the network will vary a lot depending on the topology. It can be in a firewall box, the router itself, or some random system in the middle of the network.

Here we will cover a simpler case more resembling what a home network could be like:

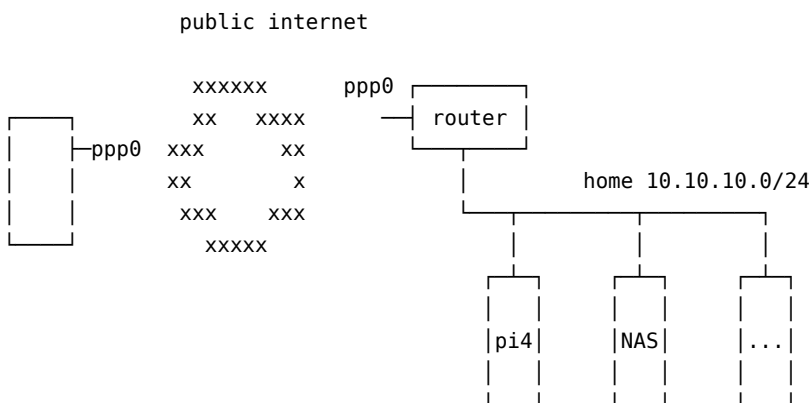

This diagram represents a typical simple home network setup. You have a router/modem, usually provided by the ISP (Internet Service Provider), and some internal devices like a Raspberry PI perhaps, a NAS (Network Attached Storage), and some other device.

There are basically two approaches that can be taken here: install WireGuard on the router, or on another system in the home network. We will discuss both in the following sections.

Note that in this scenario the “fixed” side, the home network, normally won’t have a WireGuard Endpoint configured, as the peer is typically “on the road” and will have a dynamic IP address.

In this diagram, we are depicting a home network with some devices and a router where we can install WireGuard.

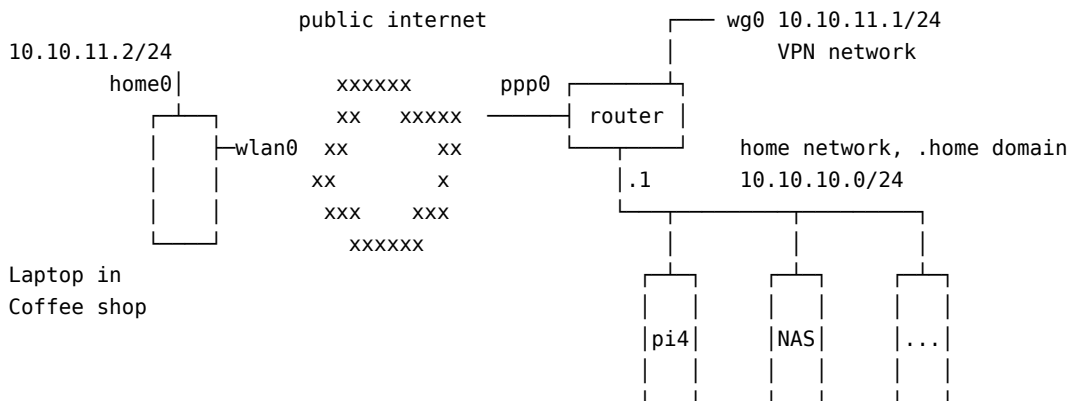

Of course, this setup is only possible if you can install software on the router. Most of the time, when it’s provided by your ISP, you can’t. But some ISPs allow their device to be put in a bridge mode, in which case you can use your own device (a computer, or a Raspberry PI, or something else) as the routing device.

Since the router is the default gateway of the network already, this means you can create a whole new network for your VPN users. You also won’t have to create any (D)NAT rules since the router is directly reachable from the Internet.

Let’s define some addresses, networks, and terms used in this guide:

- *laptop in coffee shop*: just your normal user at a coffee shop, using the provided WiFi access to connect to their home network. This will be one of our *peers* in the VPN setup.
- *home0*: this will be the WireGuard interface on the laptop. It’s called *home0* to convey the information that it is used to connect to the *home* network.
- *router*: the existing router at the home network. It has a public interface *ppp0* that has a routable but dynamic IPv4 address (not CGNAT), and an internal interface at `10.10.10.1/24` which is the default gateway for the home network.
- *home network*: the existing home network, `10.10.10.0/24` in this example, with existing devices that the user wishes to access remotely over the WireGuard VPN.
- `10.10.11.0/24`: the WireGuard VPN network. This is a whole new network that was created just for the VPN users.
- *wg0* on the *router*: this is the WireGuard interface that we will bring up on the router, at the `10.10.11.1/24` address. It is the gateway for the `10.10.11.0/24` VPN network.

With this topology, if, say, the NAS wants to send traffic to `10.10.11.2/24`, it will send it to the default gateway (since the NAS has no specific route to `10.10.11.0/24`), and the gateway will know how to send it to `10.10.11.2/24` because it has the *wg0* interface on that network.

## Configuration

First, we need to create keys for the peers of this setup. We need one pair of keys for the laptop, and another for the home router:

```
$ umask 077
$ wg genkey > laptop-private.key
$ wg pubkey < laptop-private.key > laptop-public.key
$ wg genkey > router-private.key
$ wg pubkey < router-private.key > router-public.key
```

Let’s create the router *wg0* interface configuration file. The file will be `/etc/wireguard/wg0.conf` and have these contents:

```
[Interface]
PrivateKey = <contents-of-router-private.key>
ListenPort = 51000
Address = 10.10.11.1/24
```

```
[Peer]
```

```
PublicKey = <contents-of-laptop-public.key>
AllowedIPs = 10.10.11.2
```

There is no `Endpoint` configured for the laptop peer, because we don't know what IP address it will have beforehand, nor will that IP address be always the same. This laptop can be connecting from a coffee shop free wifi, or an airport lounge, or a friend's house.

Not having an endpoint here also means that the home network side will never be able to *initiate* the VPN connection. It will sit and wait, and can only *respond* to VPN handshake requests, at which time it will learn the endpoint from the peer and use that until it changes (the peer reconnects from a different site) or times out.

### IMPORTANT

This configuration file contains a secret: **PrivateKey**. Make sure to adjust its permissions accordingly, like:

```
sudo chmod 0600 /etc/wireguard/wg0.conf
sudo chown root: /etc/wireguard/wg0.conf
```

When activated, this will bring up a `wg0` interface with the address `10.10.11.1/24`, listening on port `51000/udp`, and add a route for the `10.10.11.0/24` network using that interface.

The `Peer` section is identifying a peer via its public key, and listing who can connect from that peer. This `AllowedIPs` setting has two meanings:

- When sending packets, the `AllowedIPs` list serves as a routing table, indicating that this peer's public key should be used to encrypt the traffic.
- When receiving packets, `AllowedIPs` behaves like an access control list. After decryption, the traffic is only allowed if it matches the list.

Finally, the `ListenPort` parameter specifies the `UDP` port on which WireGuard will listen for traffic. This port will have to be allowed in the firewall rules of the router. There is no default nor a standard port for WireGuard, so you can pick any value you prefer.

Now let's create a similar configuration on the other peer, the laptop. Here the interface is called `home0`, so the configuration file is `/etc/wireguard/home0.conf`:

```
[Interface]
PrivateKey = <contents-of-laptop-private.key>
ListenPort = 51000
Address = 10.10.11.2/24
```

```
[Peer]
PublicKey = <contents-of-router-public.key>
Endpoint = <home-ppp0-IP-or-hostname>:51000
AllowedIPs = 10.10.11.0/24,10.10.10.0/24
```

### IMPORTANT

Like before, this configuration file contains a secret: **PrivateKey**. Make sure to adjust its permissions accordingly, like:

```
sudo chmod 0600 /etc/wireguard/home0.conf
sudo chown root: /etc/wireguard/home0.conf
```

We have given this laptop the `10.10.11.2/24` address. It could have been any valid address in the `10.10.11.0/24` network, as long as it doesn't collide with an existing one, and is allowed in the router's peer's `AllowedIPs` list.

### NOTE

You may have noticed by now that address allocation is manual, and not via something like DHCP. Keep tabs on it!

In the `[Peer]` stanza for the laptop we have:

- The usual `PublicKey` item, which identifies the peer. Traffic to this peer will be encrypted using this public key.
- `Endpoint`: this tells WireGuard where to actually send the encrypted traffic to. Since in our scenario the laptop will be initiating connections, it has to know the public IP address of the home router. If your ISP gave you a fixed IP address, great, nothing else to do. If however you have a dynamic IP address, one that changes everytime you establish a new connection, then you will have to setup some sort of dynamic DNS service. There are many free such services available on the Internet, but setting one up is out of scope for this guide.



- In `AllowedIPs` we list our destinations. The VPN network `10.10.11.0/24` is listed so that we can ping `wg0` on the home router as well as other devices on the same VPN, and the actual home network, which is `10.10.10.0/24`.

If we had used `0.0.0.0/0` alone in `AllowedIPs`, then the VPN would become our default gateway, and all traffic would be sent to this peer. See [Default Gateway](#) for details on that type of setup.

## Testing

With these configuration files in place, it's time to bring the WireGuard interfaces up.

On the home router, run:

```
$ sudo wg-quick up wg0
[#] ip link add wg0 type wireguard
[#] wg setconf wg0 /dev/fd/63
[#] ip -4 address add 10.10.11.1/24 dev wg0
[#] ip link set mtu 1378 up dev wg0
```

Verify you have a `wg0` interface with an address of `10.10.11.1/24`:

```
$ ip a show dev wg0
9: wg0: <POINTOPOINT,NOARP,UP,LOWER_UP> mtu 1378 qdisc noqueue state UNKNOWN group default qlen 1000
 link/none
 inet 10.10.11.1/24 scope global wg0
 valid_lft forever preferred_lft forever
```

Verify you have a `wg0` interface up with an address of `10.10.11.1/24`:

```
$ ip a show dev wg0
9: wg0: <POINTOPOINT,NOARP,UP,LOWER_UP> mtu 1378 qdisc noqueue state UNKNOWN group default qlen 1000
 link/none
 inet 10.10.11.1/24 scope global wg0
 valid_lft forever preferred_lft forever
```

And a route to the `10.10.1.0/24` network via the `wg0` interface:

```
$ ip route | grep wg0
10.10.11.0/24 dev wg0 proto kernel scope link src 10.10.11.1
```

And `wg show` should show some status information, but no connected peer yet:

```
$ sudo wg show
interface: wg0
 public key: <router public key>
 private key: (hidden)
 listening port: 51000
```

```
peer: <laptop public key>
 allowed ips: 10.10.11.2/32
```

In particular, verify that the public keys listed match what you created and expect.

Before we start the interface on the other peer, it helps to leave the above `show` command running continuously, so we can see when there are changes:

```
$ sudo watch wg show
```

Now start the interface on the laptop:

```
$ sudo wg-quick up home0
[#] ip link add home0 type wireguard
[#] wg setconf home0 /dev/fd/63
[#] ip -4 address add 10.10.11.2/24 dev home0
[#] ip link set mtu 1420 up dev home0
[#] ip -4 route add 10.10.10.0/24 dev home0
```

Similarly, verify the interface's IP and added routes:

```
$ ip a show dev home0
24: home0: <POINTOPOINT,NOARP,UP,LOWER_UP> mtu 1420 qdisc noqueue state UNKNOWN group default qlen 1000
 link/none
 inet 10.10.11.2/24 scope global home0
```

```
valid_lft forever preferred_lft forever
```

```
$ ip route | grep home0
10.10.10.0/24 dev home0 scope link
10.10.11.0/24 dev home0 proto kernel scope link src 10.10.11.2
```

Up to this point, the `wg show` output on the home router probably didn't change. That's because we haven't sent any traffic to the home network, which didn't trigger the VPN yet. By default, WireGuard is very "quiet" on the network.

If we trigger some traffic, however, the VPN will "wake up". Let's ping the internal address of the home router a few times:

```
$ ping -c 3 10.10.10.1
PING 10.10.10.1 (10.10.10.1) 56(84) bytes of data.
64 bytes from 10.10.10.1: icmp_seq=1 ttl=64 time=603 ms
64 bytes from 10.10.10.1: icmp_seq=2 ttl=64 time=300 ms
64 bytes from 10.10.10.1: icmp_seq=3 ttl=64 time=304 ms
```

Note how the first ping was slower. That's because the VPN was "waking up" and being established. Afterwards, with the tunnel already established, the latency reduced.

At the same time, the `wg show` output on the home router will have changed to something like this:

```
$ sudo wg show
interface: wg0
 public key: <router public key>
 private key: (hidden)
 listening port: 51000

peer: <laptop public key>
 endpoint: <laptop public IP>:51000
 allowed ips: 10.10.11.2/32
 latest handshake: 1 minute, 8 seconds ago
 transfer: 564 B received, 476 B sent
```

Sometimes it's not possible to install WireGuard on the home router itself. Perhaps it's a closed system to which you do not have access, or there is no easy build for that architecture, or any other of the many possible reasons.

But you do have a spare system inside your network that you could use. Here we are going to show one way to make this work. There are others, but we believe this to be the one less involved as it only requires a couple of (very common) changes in the router itself: NAT port forwarding, and DHCP range editing.

To recap, our home network has the `10.10.10.0/24` address, and we want to connect to it from a remote location and be "inserted" into that network as if we were there:

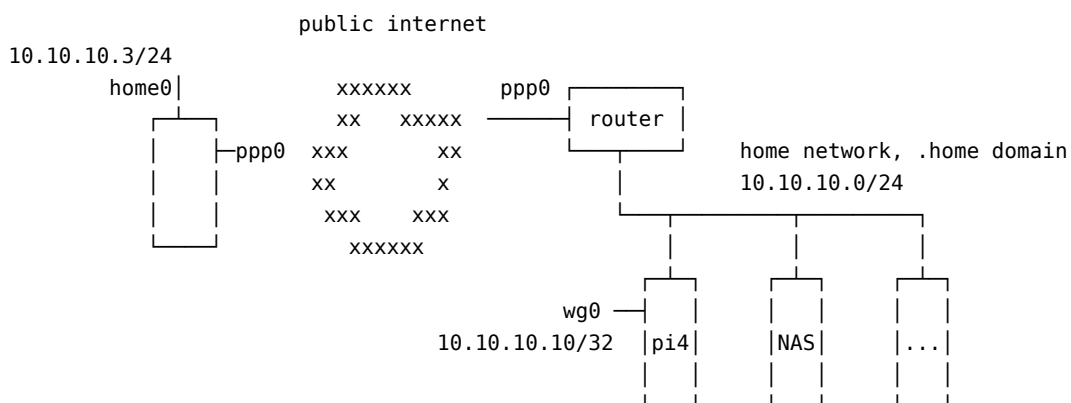

```
Reserved for VPN users:
10.10.10.2-9
```

## Router changes

Since in this scenario we don't have a new network dedicated to our VPN users, we need to "carve out" a section of the home network and reserve it to the VPN.

The easiest way to reserve IPs for the VPN is to change the router configuration (assuming it's responsible for DHCP in this network) and tell its DHCP server to only hand out addresses from a specific range, leaving a "hole" for our VPN users.

For example, in the case of the `10.10.10.0/24` network, the DHCP server on the router might already be configured to hand out IP addresses from `10.10.10.2` through `10.10.10.254`. We can carve out a “hole” for our VPN users by reducing the DHCP range, like below:

Network	<code>10.10.10.0/24</code>
Usable Addresses	<code>10.10.10.2 - 10.10.10.254</code> (.1 is the router)
DHCP Range	<code>10.10.10.50 - 10.10.10.254</code>
VPN Range	<code>10.10.10.10 - 10.10.10.59</code>

Or any other layout that is better suited for your case. In that way, the router will never hand out a DHCP address that conflicts with one that we selected for a VPN user.

The second change we need to do in the router is to port forward the WireGuard traffic to the internal system that will be the endpoint. In the diagram above, we selected the `10.10.10.10` system to be the internal WireGuard endpoint, and we will run it on the `51000/udp` port. Therefore, you need to configure the router to forward all `51000/udp` traffic to `10.10.10.10` on the same `51000/udp` port.

Finally, we also need to allow hosts on the internet to send traffic to the router on the `51000/udp` port we selected for WireGuard. This is done in the firewall rules of the device. Sometimes just doing the port forwarding from before also configures the firewall to allow that traffic, but better check.

Now we are ready to configure the internal endpoint.

## Configuring the internal WireGuard endpoint

Install the `wireguard` package:

```
$ sudo apt install wireguard
```

Generate the keys for this host:

```
$ umask 077
$ wg genkey > internal-private.key
$ wg pubkey < internal-private.key > internal-public.key
```

And create the `/etc/wireguard/wg0.conf` file with these contents:

```
[Interface]
Address = 10.10.10.10/32
ListenPort = 51000
PrivateKey = <contents of internal-private.key>

[Peer]
laptop
PublicKey = <contents of laptop-public.key>
AllowedIPs = 10.10.10.11/32 # any available IP in the VPN range
```

### NOTE

Just like in the *Peer to Site* scenario with WireGuard on the router, there is no Endpoint configuration here for the laptop peer, because we don't know where it will be connecting from beforehand.

The final step is to configure this internal system as a router for the VPN users. For that, we need to enable a couple of settings:

- `ip_forward`: to enable forwarding (aka, routing) of traffic between interfaces.
- `proxy_arp`: to reply to `arp` requests on behalf of the VPN systems, as if they were locally present on the network segment.

To do that, and make it persist across reboots, create the file `/etc/sysctl.d/70-wireguard-routing.conf` file with this content:

```
net.ipv4.ip_forward = 1
net.ipv4.conf.all.proxy_arp = 1
```

Then run this command to apply those settings:

```
$ sudo sysctl -p /etc/sysctl.d/70-wireguard-routing.conf -w
```

Now the WireGuard interface can be brought up:

```
$ sudo wg-quick up wg0
```

## Configuring the peer

The peer configuration will be very similar to what was done before. What changes will be the address, since now it won't be on an exclusive network for the VPN, but have an address carved out of the home network block.

Let's call this new configuration file `/etc/wireguard/home_internal.conf`:

```
[Interface]
ListenPort = 51000
Address = 10.10.10.11/24
PrivateKey = <contents of the private key for this system>

[Peer]
PublicKey = <contents of internal-public.key>
Endpoint = <home-ppp0-IP-or-hostname>:51000
AllowedIPs = 10.10.10.0/24
```

And bring up this WireGuard interface:

```
$ sudo wg-quick up home_internal
```

### NOTE

There is no need to add an index number to the end of the interface name. That is a convention, but not strictly a requirement.

## Testing

With the WireGuard interfaces up on both peers, traffic should flow seamlessly in the `10.10.10.0/24` network between remote and local systems.

More specifically, it's best to test the non-trivial cases, that is, traffic between the remote peer and a host other than the one with the WireGuard interface on the home network.

Another usual VPN configuration where one could deploy WireGuard is to connect two distinct networks over the internet. Here is a simplified diagram:

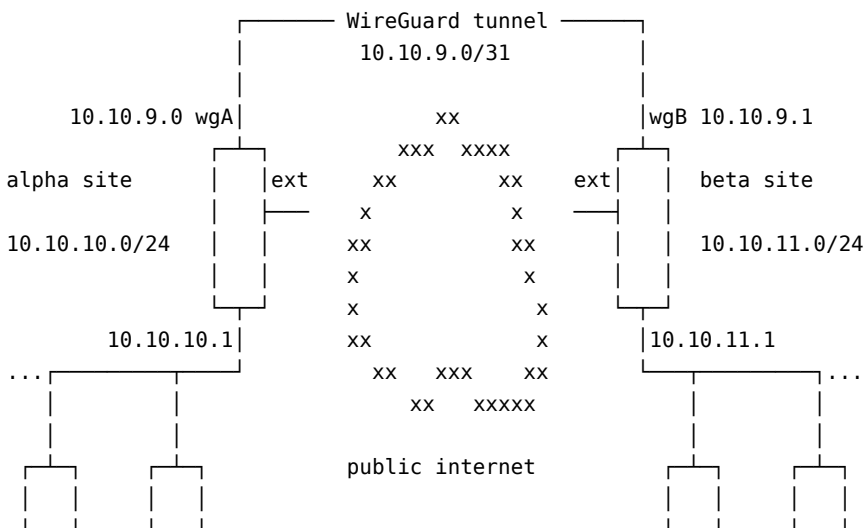

The goal here is to seamlessly integrate network `*alpha*` with network `*beta*`, so that systems on the `*alpha*` site can transparently access systems on the `*beta*` site, and vice-versa.

Such a setup as a few particular details:

- Both peers are likely to be always up and running.
- We can't assume one side will always be the initiator, like the laptop in a coffee shop scenario.
- Because of the above, both peers should have a static endpoint, like a fixed IP address, or valid domain name.

- Since we are not assigning VPN IPs to all systems on each side, the VPN network here will be very small (a /31, which allows for two IPs) and only used for routing. The only systems with an IP in the VPN network are the gateways themselves.
- There will be no NAT applied to traffic going over the WireGuard network. Therefore, the networks of both sites *must* be different and not overlap.

This is what an *mtr* report from a system in the *beta* network to an *alpha* system will look like:

```
ubuntu@b1:~$ mtr -n -r 10.10.10.230
Start: 2022-09-02T18:56:51+0000
HOST: b1
 Loss% Snt Last Avg Best Wrst StDev
 1. |-- 10.10.11.1 0.0% 10 0.1 0.1 0.1 0.2 0.0
 2. |-- 10.10.9.0 0.0% 10 299.6 299.3 298.3 300.0 0.6
 3. |-- 10.10.10.230 0.0% 10 299.1 299.1 298.0 300.2 0.6
```

### NOTE

Technically, a /31 CIDR network has no usable IP addresses, since the first one is the network address, and the second (and last) one is the broadcast address. [RFC 3021](#) however allows for it, but if you encounter routing or other networking issues, switch to a /30 CIDR and its two valid host ips.

## Configuring WireGuard

On the system that is the gateway for each site, and has internet connectivity, we start by installing WireGuard and generating the keys. For the *alpha* site:

```
$ sudo apt install wireguard
$ wg genkey | sudo tee /etc/wireguard/wgA.key
$ sudo cat /etc/wireguard/wgA.key | wg pubkey | sudo tee /etc/wireguard/wgA.pub
```

And the configuration on *alpha* will be:

```
[Interface]
PostUp = wg set %i private-key /etc/wireguard/%i.key
Address = 10.10.9.0/31
ListenPort = 51000

[Peer]
beta site
PublicKey = <contents of /etc/wireguard/wgB.pub>
AllowedIPs = 10.10.11.0/24,10.10.9.0/31
Endpoint = <beta-gw-ip>:51000
```

On the gateway for the *beta* site we take similar steps:

```
$ sudo apt install wireguard
$ wg genkey | sudo tee /etc/wireguard/wgB.key
$ sudo cat /etc/wireguard/wgB.key | wg pubkey | sudo tee /etc/wireguard/wgB.pub
```

And create the corresponding configuration file for *beta*:

```
[Interface]
Address = 10.10.9.1/31
PostUp = wg set %i private-key /etc/wireguard/%i.key
ListenPort = 51000

[Peer]
alpha site
PublicKey = <contents of /etc/wireguard/wgA.pub>
AllowedIPs = 10.10.10.0/24,10.10.9.0/31
Endpoint = <alpha-gw-ip>:51000
```

### IMPORTANT

WireGuard is being setup on the gateways for these two networks. As such, there are no changes needed on individual hosts of each network, but keep in mind that the WireGuard tunneling and encryption is only happening between the *alpha* and *beta* gateways, and **NOT** between the hosts of each network.

## Bringing the interfaces up

Since this VPN is permanent between static sites, it's best to use the *systemd* unit file for *wg-quick* to bring the interfaces up and control them in general. In particular, we want them to be brought up automatically on reboot events.

On *alpha*:

```
$ sudo systemctl enable --now wg-quick@wgA
```

And similarly on *beta*:

```
$ sudo systemctl enable --now wg-quick@wgB
```

This both enables the interface on reboot, and starts it right away.

## Firewall and routing

Both gateways probably already have some routing and firewall rules. These might need changes depending on how they are setup.

The individual hosts on each network won't need any changes regarding the remote *alpha* or *beta* networks, because they will just send that traffic to the default gateway (as any other non-local traffic), which knows how to route it because of the routes that *wg-quick* added.

In the configuration we did so far, there have been no restrictions in place, so traffic between both sites flows without impediments.

In general, what needs to be done or checked is:

- Make sure both gateways can contact each other on the specified endpoint addresses and UDP port. In the case of this example, that's port 51000. For extra security, create a firewall rule only allowing each peer to contact this port, instead of the Internet at large.
- Do NOT masquerade or NAT the traffic coming from the internal network and going out via the WireGuard interface towards the other site. This is purely routed traffic.
- There shouldn't be any routing changes needed on the gateways, since *wg-quick* takes care of adding the route for the remote site, but do check the routing table to see if it makes sense (`ip route` and `ip route | grep wg` are a good start).
- You may have to create new firewall rules if you need to restrict traffic between the *alpha* and *beta* networks. For example, if you want to prevent *ssh* between the sites, you could add a firewall rule like this one to *alpha*:

```
$ sudo iptables -A FORWARD -i wgA -p tcp --dport 22 -j REJECT
```

And similarly on *beta*:

```
$ sudo iptables -A FORWARD -i wgB -p tcp --dport 22 -j REJECT
```

You can add these as *PostUp* actions in the WireGuard interface config. Just don't forget to remove them in the corresponding *PreDown* hook, or you will end up with multiple rules.

WireGuard can also be setup to route all traffic through the VPN, and not just specific remote networks. There could be many reasons for this, but mostly they are related to privacy.

Here we will assume a scenario where the local network is considered untrusted, and we want to leak as little information as possible about our behavior on the Internet. This could be the case of an airport, or a coffee shop, a conference, a hotel, or any other public network.

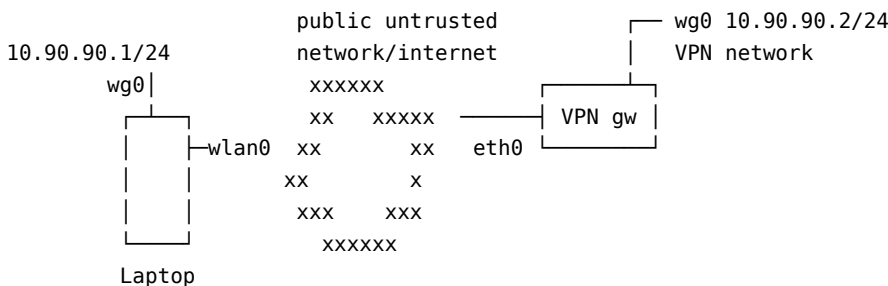

For this to work best, we need a system we can reach on the internet and that we control. Most commonly this can be a simple small VM in a public cloud, but a home network also works. Here we will assume it's a brand new system that will be configured from scratch for this very specific purpose.

## WireGuard Configuration

Let's start the configuration by installing WireGuard and generating the keys.

On the client:

```
$ sudo apt install wireguard
$ umask 077
$ wg genkey > wg0.key
$ wg pubkey < wg0.key > wg0.pub
$ sudo mv wg0.key wg0.pub /etc/wireguard
```

And on the gateway server:

```
$ sudo apt install wireguard
$ umask 077
$ wg genkey > gateway0.key
$ wg pubkey < gateway0.key > gateway0.pub
$ sudo mv gateway0.key gateway0.pub /etc/wireguard
```

On the client, we will create `/etc/wireguard/wg0.conf`:

```
[Interface]
PostUp = wg set %i private-key /etc/wireguard/wg0.key
ListenPort = 51000
Address = 10.90.90.1/24

[Peer]
PublicKey = <contents of gateway0.pub>
Endpoint = <public IP of gateway server>
AllowedIPs = 0.0.0.0/0
```

Key points here:

- We selected the `10.90.90.1/24` IP address for the WireGuard interface. This can be any private IP address, as long as it doesn't conflict with the network you are on, so double check that. If it needs changing, don't forget to also change the IP for the WireGuard interface on the gateway server.
- The `AllowedIPs` value is `0.0.0.0/0`, which means "all IPv4 addresses".
- We are using `PostUp` to load the private key instead of specifying it directly in the configuration file, so we don't have to set the permissions on the config file to `0600`.

The counterpart configuration on the gateway server is `/etc/wireguard/gateway0.conf` with these contents:

```
[Interface]
PostUp = wg set %i private-key /etc/wireguard/%i.key
Address = 10.90.90.2/24
ListenPort = 51000

[Peer]
PublicKey = <contents of wg0.pub>
AllowedIPs = 10.90.90.1/32
```

Since we don't know from where this remote peer will be connecting, there is no `Endpoint` setting for it, and the expectation is that the peer will be the one initiating the VPN.

This finishes the WireGuard configuration on both ends, but there is one extra step we need to take on the gateway server.

## Routing and masquerading

The WireGuard configuration that we did so far is enough to send the traffic from the client in the untrusted network, to the gateway server. But what about from there on? There are two extra configs we need to make on the gateway server:

- Masquerade (or apply source NAT rules) the traffic from `10.90.90.1/24`.
- Enable IPv4 forwarding so our gateway server acts as a router.

To enable routing, create `/etc/sysctl.d/70-wireguard-routing.conf` with this content:

```
net.ipv4.ip_forward = 1
```

And run:

```
$ sudo sysctl -p /etc/sysctl.d/70-wireguard-routing.conf -w
```

To masquerade the traffic from the VPN, one simple rule is needed:

```
$ sudo iptables -t nat -A POSTROUTING -s 10.90.90.0/24 -o eth0 -j MASQUERADE
```

Replace `eth0` with the name of the network interface on the gateway server, if it's different.

To have this rule persist across reboots, you can add it to `/etc/rc.local` (create the file if it doesn't exist and make it executable):

```
#!/bin/sh
iptables -t nat -A POSTROUTING -s 10.90.90.0/24 -o eth0 -j MASQUERADE
```

This completes the gateway server configuration.

## Testing

Let's bring up the WireGuard interfaces on both peers.

On the gateway server:

```
$ sudo wg-quick up gateway0
[#] ip link add gateway0 type wireguard
[#] wg setconf gateway0 /dev/fd/63
[#] ip -4 address add 10.90.90.2/24 dev gateway0
[#] ip link set mtu 1378 up dev gateway0
[#] wg set gateway0 private-key /etc/wireguard/gateway0.key
```

And on the client:

```
$ sudo wg-quick up wg0
[#] ip link add wg0 type wireguard
[#] wg setconf wg0 /dev/fd/63
[#] ip -4 address add 10.90.90.1/24 dev wg0
[#] ip link set mtu 1420 up dev wg0
[#] wg set wg0 fwmark 51820
[#] ip -4 route add 0.0.0.0/0 dev wg0 table 51820
[#] ip -4 rule add not fwmark 51820 table 51820
[#] ip -4 rule add table main suppress_prefixlength 0
[#] sysctl -q net.ipv4.conf.all.src_valid_mark=1
[#] nft -f /dev/fd/63
[#] wg set wg0 private-key /etc/wireguard/wg0.key
```

From the client you should now be able to verify that your traffic reaching out to the internet is going through the gateway server via the WireGuard VPN. For example:

```
$ mtr -r 1.1.1.1
Start: 2022-09-01T12:42:59+0000
HOST: laptop.lan
 Loss% Snt Last Avg Best Wrst StDev
 1. |-- 10.90.90.2 0.0% 10 184.9 185.5 184.9 186.9 0.6
 2. |-- 10.48.128.1 0.0% 10 185.6 185.8 185.2 188.3 0.9
 (...)
 7. |-- one.one.one.one 0.0% 10 186.2 186.3 185.9 186.6 0.2
```

Above, hop 1 is the `gateway0` interface on the gateway server, then `10.48.128.1` is the default gateway for that server, then come some in between hops, and the final hit is the target.

If you just look at the output of `ip route`, however, it's not immediately obvious that the WireGuard VPN is the default gateway:

```
$ ip route
default via 192.168.122.1 dev enp1s0 proto dhcp src 192.168.122.160 metric 100
10.90.90.0/24 dev wg0 proto kernel scope link src 10.90.90.1
192.168.122.0/24 dev enp1s0 proto kernel scope link src 192.168.122.160 metric 100
192.168.122.1 dev enp1s0 proto dhcp scope link src 192.168.122.160 metric 100
```

That's because WireGuard is using *fwmarks* and policy routing. WireGuard cannot simply set the `wg0` interface as the default gateway: that traffic needs to reach the specified endpoint on port 51000/UDP outside of the VPN tunnel.

If you want to dive deeper into how this works, check `ip rule list`, `ip route list table 51820`, and consult the documentation on "Linux Policy Routing".



## DNS leaks

The traffic is now being routed through the VPN to the gateway server that you control, and from there on to the Internet at large. The local network you are in cannot see the contents of that traffic, because it's encrypted. But you are still leaking information about the sites you access via DNS.

When the laptop got its IP address in the local (untrusted) network it is sitting in, it likely also got a pair of IPs for DNS servers to use. These might be servers from that local network, or other DNS servers from the internet like 1.1.1.1 or 8.8.8.8. When you access an internet site, a DNS query will be sent to those servers to discover their IP addresses. Sure, that traffic goes over the VPN, but at some point it exits the VPN, and then reaches those servers, which will then know what you are trying to access.

There are DNS leak detectors out there, and if you want a quick check you can try out <https://dnsleaktest.com>. It will tell you which DNS servers your connection is using, and it's up to you if you trust them or not. You might be surprised that, even if you are in a conference network for example, using a default gateway VPN like the one described here, you are still using the DNS servers from the conference infrastructure. In a way, the DNS traffic is leaving your machine encrypted, and then coming back in clear text to the local DNS server.

There are basically two things you can do about this: select a specific DNS server to use for your VPN connection, or install your own DNS server.

### Selecting a DNS server

If you can use a DNS server that you trust, or don't mind using, that is probably the easiest solution. Many people would start with the DNS server assigned to the gateway server used for the VPN. This address can be checked by running the following command in a shell on the gateway server:

```
$ resolvectl status
Global
 Protocols: -LLMNR -mDNS -DNSoverTLS DNSSEC=no/unsupported
resolv.conf mode: stub

Link 2 (ens2)
 Current Scopes: DNS
 Protocols: +DefaultRoute +LLMNR -mDNS -DNSoverTLS DNSSEC=no/unsupported
Current DNS Server: 10.48.0.5
 DNS Servers: 10.48.0.5
 DNS Domain: openstacklocal
```

```
Link 5 (gateway0)
Current Scopes: none
 Protocols: -DefaultRoute +LLMNR -mDNS -DNSoverTLS DNSSEC=no/unsupported
```

Look for Current DNS Server. In the example above, it's 10.48.0.5.

Let's change the WireGuard wg0 interface config to use that DNS server. Edit /etc/wireguard/wg0.conf and add a second PostUp line with the resolvectl command like below:

```
[Interface]
PostUp = wg set %i private-key /etc/wireguard/wg0.key
PostUp = resolvectl dns %i 10.48.0.5; resolvectl domain %i \~.
ListenPort = 51000
Address = 10.90.90.1/24

[Peer]
PublicKey = <contents of gateway0.pub>
Endpoint = <public IP of gateway server>
AllowedIPs = 0.0.0.0/0
```

You can run that resolvectl command by hand if you want to avoid having to restart the WireGuard VPN:

```
$ sudo resolvectl dns wg0 10.48.0.5; sudo resolvectl domain wg0 \~.
```

Or just restart the WireGuard interface:

```
$ sudo wg-quick down wg0; sudo wg-quick up wg0
```

And if you check again for DNS leaks, this time you'll find that you are only using the DNS server you specified.

## Installing your own DNS server

If you don't want to use even the DNS server from the hosting provider where you have your gateway server, another alternative is to install your own DNS server.

There are multiple choices out there for this: `bind9` and `unbound` are quite popular, and easy to find quick tutorials and instructions on how to do it.

Here we will proceed with `bind9`, which is in the Ubuntu Main repository.

On the gateway server, install the `bind9` package:

```
$ sudo apt install bind9
```

And that's it for the server part.

On the client, add a `PostUp` line specifying this IP (or change the line we added in the previous section):

```
[Interface]
PostUp = wg set %i private-key /etc/wireguard/wg0.key
PostUp = resolvectl dns %i 10.90.90.2; resolvectl domain %i \-.
ListenPort = 51000
Address = 10.90.90.1/24

[Peer]
PublicKey = <contents of gateway0.pub>
Endpoint = <public IP of gateway server>
AllowedIPs = 0.0.0.0/0
```

And restart the WireGuard interface. Now your VPN client will be using the gateway server as the DNS server.

Here are some common tasks and other helpful tips that can help you in your WireGuard deployment.

## Controlling the WireGuard interface with `systemd`

The `wg-quick` tool is a simple way to bring the WireGuard interface up and down. That control is also exposed via a `systemd` service, which means the standard `systemctl` tool can be used.

Probably the best benefit of this is to be able to configure the interface to be brought up automatically when the system is booted up. For example, to configure the `wg0` interface to be brought up at boot:

```
$ sudo systemctl enable wg-quick@wg0
```

The name of the `systemd` service follows the WireGuard interface name, and multiple such services can be enabled/started at the same time. You can also use the `systemctl status`, `start`, `stop`, `reload` and `restart` commands to control the WireGuard interface and query its status:

```
$ sudo systemctl reload wg-quick@wg0
```

The `reload` action does what we expect: it reloads the configuration of the interface without disrupting existing WireGuard tunnels. To add or remove peers, `reload` is sufficient, but if `wg-quick` options, like `PostUp`, `Address` or others alike, are changed, then a `restart` is needed.

## DNS resolving

Let's say when you are inside the home network, literally at home, you can connect to your other systems via DNS names, because your router at `10.10.10.1` can act as an internal DNS server. It would be nice to have this capability also when connected via the WireGuard VPN.

To do that, we can add a `PostUp` command to the WireGuard configuration to run a command for us right after the VPN is established. This command can be anything you would run in a shell, as root. We can use that to adjust the DNS resolver configuration of the laptop that is remotely connected to the home network.

For example, if we have a WireGuard setup as follows:

- `home0` WireGuard interface.
- `.home` DNS domain for the remote network.
- `10.10.10.1/24` is the DNS server for the `.home` domain, reachable after the VPN is established.

We can add this `PostUp` command to the `home0.conf` configuration file to have our `systemd`-based resolver use `10.10.10.1` as the DNS server for any queries for the `.home` domain:

```
[Interface]
```

```
...
```

```
PostUp = resolvectl dns %i 10.10.10.1; resolvectl domain %i \~home
```

For `PostUp` (and `PostDown`, see the `wg-quick(8)` manpage for details), the `%i` text is replaced with the WireGuard interface name. In this case, that would be `home0`.

These two `resolvectl` commands tell the local `systemd-resolved` resolver to a) associate the DNS server at `10.10.10.1` to the `home0` interface; and b) associate the `home` domain to the `home0` interface.

When you bring the `home0` WireGuard interface up again, it will run the `resolvectl` commands:

```
$ sudo wg-quick up home0
[#] ip link add home0 type wireguard
[#] wg setconf home0 /dev/fd/63
[#] ip -4 address add 10.10.11.2/24 dev home0
[#] ip link set mtu 1420 up dev home0
[#] ip -4 route add 10.10.10.0/24 dev home0
[#] resolvectl dns home0 10.10.10.1; resolvectl domain home0 \~home
```

You can verify that it worked by pinging some hostname in your home network, or checking the DNS resolution status for the `home0` interface:

```
$ resolvectl status home0
Link 26 (home0)
 Current Scopes: DNS
 Protocols: -DefaultRoute +LLMNR -mDNS -DNSOverTLS DNSSEC=no/unsupported
Current DNS Server: 10.10.10.1
 DNS Servers: 10.10.10.1
 DNS Domain: ~home
```

If you are using `systemctl` to control the WireGuard interface, this is the type of change (adding or changing `PostUp`) where the `reload` action won't be enough, and you actually need to issue a `restart`.

#### NOTE

The `wg-quick(8)` manpage documents the DNS setting of the WireGuard interface which has the same purpose, but only works if you have `resolveconf` installed. Ubuntu systems by default don't, and rely on `systemd-resolved` instead.

## Adding another peer

To add another peer to an existing WireGuard setup, we have to:

1. generate a new keypair for the new peer
2. create a new `[Peer]` section on the "other side" of the WireGuard setup
3. pick a new IP for the new peer

Let's call the new system `ontheroad`, and generate the keys for it:

```
$ umask 077
$ wg genkey > ontheroad-private.key
$ wg pubkey < ontheroad-private.key > ontheroad-public.key
$ ls -la ontheroad.*
-rw----- 1 ubuntu ubuntu 45 Aug 22 20:12 ontheroad-private.key
-rw----- 1 ubuntu ubuntu 45 Aug 22 20:13 ontheroad-public.key
```

As for its IP address, let's pick `10.10.11.3/24` for it, which is the next one in sequence of one of the previous examples in this guide:

```
[Interface]
```

```
PrivateKey = <contents-of-ontheroad-private.key>
```

```
ListenPort = 51000
```

```
Address = 10.10.11.3/24
```

```
[Peer]
```

```
PublicKey = <contents-of-router-public.key>
```

```
Endpoint = <home-ppp0-IP-or-hostname>:51000
```

```
AllowedIPs = 10.10.11.0/24,10.10.10.0/24
```

The only difference between this config and one for an existing system in this same WireGuard setup will be `PrivateKey` and `Address`.

On the “other side”, we add the new `[Peer]` section to the existing config:

```
[Interface]
PrivateKey = <contents-of-router-private.key>
ListenPort = 51000
Address = 10.10.11.1/24
```

```
[Peer]
laptop
PublicKey = <contents-of-laptop-public.key>
AllowedIPs = 10.10.11.2
```

```
[Peer]
ontheroad
PublicKey = <contents-of-ontheroad-public.key>
AllowedIPs = 10.10.11.3
```

To update the interface with the new peer without disrupting existing connections, we use the `reload` action of the `systemd` unit:

```
$ systemctl reload wg-quick@wg0
```

#### NOTE

For this case of a “server” or “vpn gateway”, where we are just adding another peer to an existing config, the `systemctl reload` action will work well enough to insert the new peer in the wireguard configuration. But it won’t create new routes, or do any of the other steps that `wg-quick` does. Depending on the setup, you might need a full restart so that `wg-quick` can fully do its job.

## Adding a smartphone peer

WireGuard can be installed on many different platforms, and smartphones are included. The upstream installation page has links for [Android](#) and [iOS](#) apps.

Such a mobile client can be configured more easily with the use of QR codes.

We start by creating the new peer’s config normally, as if it were any other system (generate keys, pick an IP address, etc). Then, to convert that configuration file to a QR code, install the `qrencode` package:

```
$ sudo apt install qrencode
```

And run the following command (assuming the config was written to `phone.conf`):

```
$ cat phone.conf | qrencode -t ansiutf8
```

That will generate a QR code in the terminal, ready for scanning with the smartphone app. Note that there is no need for a graphical environment, and this command can be run remotely over SSH for example.

Note that you need to put the private key contents directly into that configuration file, and not use `PostUp` to load it from a separate file.

#### IMPORTANT

Treat this QR code as a secret, as it contains the private key for the wireguard interface!

Here are some security tips for your WireGuard deployment.

## Traffic goes both ways

Remember that the VPN traffic goes both ways. Once you are connected to the remote network, it means any device on that network can connect back to you! That is, unless you create specific firewall rules for this VPN network.

Since WireGuard is “just” an interface, you can create normal firewall rules for its traffic, and control the access to the network resources as usual. This is done more easily if you have a dedicated network for the VPN clients.

## Using PreSharedKey

You may add another layer of cryptographic protection to your VPN with the `PreSharedKey` option. Its usage is optional, and adds a layer of symmetric-key cryptography to the traffic between specific peers.

Such a key can be generated with the `genpsk` command:

```
$ wg genpsk
vxlX6eMMin8uhxbKEhe/i0xi8ru+q1qWzCdJESXoFZY=
```

And then used in a `[Peer]` section, like this:

```
[Peer]
PublicKey =
Endpoint =
AllowedIPs =
PresharedKey = vxlX6eMMin8uhxbKEhe/i0xi8ru+q1qWzCdJESXoFZY=
```

**Both sides need to have the same PresharedKey in their respective `[Peer]` sections.**

## Preventing accidental leakage of the private keys

When troubleshooting WireGuard, it's common to post the contents of the interface configuration file somewhere for others to help, like in a mailing list, or internet forum. Since the private key is listed in that file, one has to remember to strip or obfuscate it before sharing, or else the secret is leaked.

To avoid such mistakes, we can remove the private key from the configuration and leave it in its own file. This can be done via a **PostUp** hook. For example, let's update the `home0.conf` file to use such a hook:

```
[Interface]
ListenPort = 51000
Address = 10.10.11.3/24
PostUp = wg set %i private-key /etc/wireguard/%i.key
```

```
[Peer]
PublicKey = <contents-of-router-public.key>
Endpoint = 10.48.132.39:51000
AllowedIPs = 10.10.11.0/24,10.10.10.0/24
```

The `%i` macro is replaced by the WireGuard interface name (`home0` in this case). When the interface comes up, the `PostUp` shell commands will be executed with that substitution in place, and the private key for this interface will be set with the contents of the `/etc/wireguard/home0.key` file.

There are some other advantages to this method, and perhaps one disadvantage.

Pros:

- The configuration file can now safely be stored in version control, like a git repository, without fear of leaking the private key (unless you also use the `PreSharedKey` option, which is also a secret).
- Since the key is now stored in a file, you can give that file a meaningful name, which helps to avoid mixups with keys and peers when setting up WireGuard.

Cons:

- You cannot directly use the `qrcode` tool to convert this image to a qr code and use it to configure the mobile version of WireGuard, because that tool won't go after the private key in that separate file.

General troubleshooting checklist:

- Verify public and private keys. When dealing with multiple peers, it's easy to mix these up, specially because the contents of these keys is just random data. There is nothing identifying them, and public and private keys are basically the same format-wise.
- Verify `AllowedIPs` list on all peers.
- Check with `ip route` and `ip addr show dev <wg-interface>` if the routes and IPs are set as you expect.
- Double check that you have `/proc/sys/net/ipv4/ip_forward` set to 1 where needed.
- When injecting the VPN users into an existing network, without routing, make sure `/proc/sys/net/ipv4/conf/all/proxy_arp` is set to 1.
- Make sure the above `/proc` entries are in `/etc/sysctl.conf` or a file in `/etc/sysctl.d` so that they persist reboots.

It can be helpful to leave a terminal open with the `watch wg` command. Here is a sample output showing a system with two peers configured, where only one has established the VPN so far:

```
Every 2.0s: wg j-wg: Fri Aug 26 17:44:37 2022

interface: wg0
 public key: +T3T3HTMeyrEDvim8FBxbYjbz+/P0e0tG3RlvL9kJmM=
```

```
private key: (hidden)
listening port: 51000
```

```
peer: 2cJdFcNzXv4YUGyDTaht0frbsrFsCByatPnNzKts0Qo=
endpoint: 10.172.196.106:51000
allowed ips: 10.10.11.2/32
latest handshake: 3 hours, 27 minutes, 35 seconds ago
transfer: 3.06 KiB received, 2.80 KiB sent
```

```
peer: ZliZ1hlarZqvfxPMYME2ECtXDK611NB7uzLAD4McpGI=
allowed ips: 10.10.11.3/32
```

## Kernel debug messages

WireGuard is also silent when it comes to logging. Being a kernel module essentially, we need to explicitly enable verbose logging of its module. This is done with the following command:

```
$ echo "module wireguard +p" | sudo tee /sys/kernel/debug/dynamic_debug/control
```

This will write WireGuard logging messages to the kernel log, which can be watched live with:

```
$ sudo dmesg -wT
```

To disable logging, run this:

```
$ echo "module wireguard -p" | sudo tee /sys/kernel/debug/dynamic_debug/control
```

## Destination address required

If you ping an IP and get back an error like this:

```
$ ping 10.10.11.2
PING 10.10.11.2 (10.10.11.2) 56(84) bytes of data.
From 10.10.11.1 icmp_seq=1 Destination Host Unreachable
ping: sendmsg: Destination address required
```

This is happening because the WireGuard interface selected for this destination doesn't know the endpoint for it. In other words, it doesn't know where to send the encrypted traffic.

One common scenario for this is on a peer where there is no `Endpoint` configuration, which is perfectly valid, and the host is trying to send traffic to that peer. Let's take the coffee shop scenario we described earlier as an example.

The laptop is connected to the VPN and exchanging traffic as usual. Then it stops for a bit (the person went to get one more cup). Traffic ceases (WireGuard is silent, remember). If the WireGuard on the home router is now restarted, when it comes back up, it won't know how to reach the laptop, because it was never contacted by it before. This means that at this time, if the home router tries to send traffic to the laptop in the coffee shop, it will get the above error.

Now the laptop user comes back, and generates some traffic to the home network (remember: the laptop has the home network's `Endpoint` value). The VPN "wakes up", data is exchanged, handshakes completed, and now the home router knows the `Endpoint` associated with the laptop, and can again initiate new traffic to it without issues.

Another possibility is that one of the peers is behind a NAT, and there wasn't enough traffic for the stateful firewall to consider the "connection" alive, and it dropped the NAT mapping it had. In this case, the peer might benefit from the `PersistentKeepalive` configuration, which makes WireGuard send a *keepalive* probe every so many seconds.

## Required key not available

This error:

```
$ ping 10.10.11.1
PING 10.10.11.1 (10.10.11.1) 56(84) bytes of data.
From 10.10.11.2 icmp_seq=1 Destination Host Unreachable
ping: sendmsg: Required key not available
```

Can happen when you have a route directing traffic to the WireGuard interface, but that interface does not have the target address listed in its `AllowedIPs` configuration.

If you have enabled kernel debugging for WireGuard, you will also see a message like this one in the `dmesg` output:

```
wireguard: home0: No peer has allowed IPs matching 10.10.11.1
```

Our explanatory and conceptual guides are written to provide a better understanding of how Ubuntu Server works and how it can be used and configured. They enable you to expand your knowledge, making the operating system easier to use.

## Explanation guides

---

Software

[About apt upgrade and phased updates](#)  
[Changing package files](#)

Network

[Introduction](#)  
[Configuration](#)  
[DHCP](#)  
[NTP](#)  
[DPDK](#)  
[OpenVswitch-DPDK](#)

Cryptography

[Introduction to crypto libraries](#)  
[OpenSSL](#)  
[GnuTLS](#)  
[Network Security Services \(NSS\)](#)  
[Java cryptography configuration](#)  
[BIND 9 DNSSEC cryptography selection](#)  
[OpenSSH crypto configuration](#)  
[Troubleshooting TLS/SSL](#)

---

## Introduction to...

If you're not sure how or where to get started with a topic, these introductory pages will give you a high-level overview and relevant links (with context!) to help you navigate easily to the guides and other materials of most interest to you.

---

[Introduction to Samba](#)

---

Alternatively, our *Tutorials* section contain step-by-step directions to help outline what Ubuntu Server is capable of while helping you achieve specific aims, such as installing the operating system or customizing software.

If you have a specific goal, but are already familiar with Ubuntu Server, take a look at our *How-to* guides. These have more in-depth detail and can be applied to a broader set of applications.

Also, take a look at our *Reference* when you need to determine what commands are available, and how to interact with various tools.

You may have noticed recently that updating your system with `apt upgrade` sometimes produces a weird message about packages being kept back...like this one:

```
Reading package lists... Done
Building dependency tree... Done
Reading state information... Done
Calculating upgrade... Done
The following packages have been kept back:
 (Names of <X> held back packages listed here)
0 upgraded, 0 newly installed, 0 to remove and <X> not upgraded.
```

If you've ever used combinations of packages from different releases or third party repos, you may be familiar with this message already. However, it has become a much more common occurrence due to something called "phased updates".

## What are phased updates?

Phased updates are software updates that are rolled out in stages, rather than being provided to everyone at the same time. Initially, the update is provided only to a small subset of Ubuntu machines. As the update proves to be

stable, it is provided to an ever-increasing number of users until everyone has received it (i.e., when the update is “fully phased”).

The good news is, you don’t need to do anything about the “packages kept back” message – you can safely ignore it. Once the update has been deemed safe for release, you will receive the update automatically.

## Why is Ubuntu doing this?

Although updates are thoroughly tested before they get released at all, sometimes bugs can be hidden well enough to escape our attention and make it into a release – especially in highly specific use cases that we didn’t know we needed to test. This can obviously cause problems for our users, and used to be the norm before we phased updates through `apt`.

Update phasing makes it much easier for us to detect serious breakages early on – before they have a chance to cause problems for the majority of our users. It gives us the opportunity to hold back the update until the bugs are fixed.

In other words, it directly benefits our users by increasing the safety, stability and reliability of Ubuntu.

The phasing system makes it so that different sets of users are chosen to be the first to get the updates, so that there isn’t one group of unlucky people who always get potentially broken updates soon after release.

### Note:

It should be mentioned here that security updates are *never* phased.

## Can I turn off phased updates?

That depends on how stable you need your system to be. If you just want to avoid any notices about packages being held back during `apt` updates, and you’re willing to be one of the first people to get updates whenever they’re released, you can turn off phased updates. Be warned, though – if an update *is* broken, you will almost always be in the first set of people to get it (i.e., you’re basically volunteering yourself as a guinea pig for the early update releases!). It will get rid of the “held back packages” in `apt` message, though.

If that doesn’t sound like something you want, leave phased updates on (this is the default). You will still temporarily get the “held back packages” message, but your machine will be more protected from updates that might otherwise break it – and once the packages are ready to be safely installed on your system, they will no longer be held back.

## Can I apt upgrade the individual packages? (and should I?)

While you can *technically* get around phased updates by running `apt install` on individual held back packages, it’s not recommended. You’re unlikely to break your machine by doing this – as long as the package is being held back due to update phasing.

If you want to `apt upgrade` a package, you should first carefully examine the proposed changes that `apt` would make before you proceed. If the package update was kept back for a reason unrelated to phasing, `apt` may be forced to remove packages in order to complete your request, which could then cause problems elsewhere.

## How do I turn off phased updates?

If you’re sure that you want to disable phased updates, reverting to the old behaviour, you can change `apt`’s configuration by creating a file in `/etc/apt/apt.conf.d` called `99-Phased-Updates` (if `/etc/apt/apt.conf.d/99-Phased-Updates` doesn’t already exist). In the file, simply add the following lines:

```
Update-Manager::Always-Include-Phased-Updates true;
APT::Get::Always-Include-Phased-Updates true;
```

Again, please only do this if you really know what you’re doing and are absolutely sure you need to do it (for instance, if you are intentionally installing all the latest packages to help test them – and don’t mind if your system breaks). We definitely don’t recommend turning off phased updates if you’re a newer user.

## Why is this suddenly happening now?

Phased updates have been part of the update-manager on Ubuntu Desktop for quite a while (since 13.04, in fact!), but were implemented in `APT` in 21.04. It now works on all versions of Ubuntu (including Ubuntu Server, Raspberry Pi, and containers). Since this includes the 22.04 LTS, it’s now getting a lot more attention as a result!



## How does it actually work?

Phased updates depend on a value derived from your machine’s “Machine ID”, as well as the package name and package version. The neat thing about this is that phasing is determined completely at the client end; no identifiable information (or indeed any new information at all) is ever sent to the server to achieve update phasing.

When the software update is released, the initial subset of machines to receive the update first is chosen at random. Only if there are no problems detected by the first set of users will the update be made available to everyone.

For more detailed information, including about how changes to phasing are timed, you can check the [Ubuntu wiki page on phased updates](#).

## How can I find out more information about currently phased packages?

You can find out the phasing details of a package by using the `apt policy` command:

```
apt policy <package>
```

For example, at the time of writing, the package `libglapi-mesa` has a phased update. Running `apt policy libglapi-mesa` then produces an output like this:

```
libglapi-mesa:
 Installed: 22.0.5-0ubuntu0.3
 Candidate: 22.2.5-0ubuntu0.1~22.04.1
 Version table:
 22.2.5-0ubuntu0.1~22.04.1 500 (phased 20%)
 500 http://archive.ubuntu.com/ubuntu jammy-updates/main amd64 Packages
 *** 22.0.5-0ubuntu0.3 100
 100 /var/lib/dpkg/status
 22.0.1-1ubuntu2 500
 500 http://archive.ubuntu.com/ubuntu jammy/main amd64 Packages
```

In this output you can see that this package is 20% phased.

You can see the status of all packages currently being phased in Ubuntu at <https://people.canonical.com/~ubuntu-archive/phased-updates.html>

### Note:

There is a bug report currently active about the fact that the “kept back” message is not as informative as it could be, and the issue is on our radar. If this issue also affects you, you have an Ubuntu Single Sign-On (SSO) account and can log into Launchpad, you can click on the link near the top of the page that says “This bug affects 85 people. Does this bug affect you?”. If you then click on “Yes, it affects me”, it will increase the bug heat rating, making it more significant.

## Further reading

- The details in this page are based on this [excellent post on AskUbuntu](#) by AskUbuntu user *ArrayBolt3*. This page is therefore licensed under Creative Commons Attribution-ShareAlike license, distributed under the terms of [CC BY-SA 4.0](#)
- You can check on the progress of the current [phasing Ubuntu Stable Release Updates](#).
- There is also more detail on how phased updates work in the [Ubuntu wiki](#), the [Error Tracker](#), and the [apt preferences manpage](#).

Many packages in Ubuntu will create extra files when installed. These files can contain metadata, configurations, rules for operating system interaction, and so on. In many cases, these files will be fully managed by updates to a package, leading to issues when they are modified manually. This page goes over some methods for changing the behavior of a package without causing conflicts in maintained files.

## Configuration files

Configuration files are often provided by packages. They come in many forms, but the majority can be found in the `/etc/` directory with either a `.conf` or `.cnf` extension. Most of the time, these files are managed by the package and editing them could lead to a conflict when updating. To get around this, packages will check in additional `<config>.d/` directories where you can place personal changes.

For example, if you would like `mysql-server` to run on port 3307 instead of 3306, you can open the file `/etc/mysql/mysql.conf.d/mysqld.cnf`, and edit the port option.

```
[mysqld]
#
* Basic Settings
#
user = mysql
pid-file = /var/run/mysqld/mysqld.pid
socket = /var/run/mysqld/mysqld.sock
port = 3307
```

**Note:**

Some packages do not automatically create files for you to edit in their `.d` directories. In these cases it is often acceptable to just create an additional config file by any name there. When in doubt, check the package's documentation to confirm.

After saving the file, restart the service.

```
systemctl restart mysql
```

The `netstat` command shows that this was successful:

```
netstat -tunpevaW | grep -i 3307
tcp 0 0 127.0.0.1:3307 0.0.0.0:* LISTEN 106 416022 1730/mysqld
```

## Systemd files

Many packages ship service unit files for interacting with [Systemd](#). Unit files allow packages to define background tasks, initialization behavior, and interactions with the operating system. The files, or symlinks of them, will automatically be placed in the `/lib/systemd/system/` directory. Likewise, the files can also show up in `/etc/systemd/system`. If these are edited manually they can cause major issues when updating or even running in general.

Instead, if you would like to modify a unit file, do so through `Systemd`. It provides the command `systemctl edit <service>` which creates an override file and brings up a text editor for you to edit it.

For example, if you want to edit `Apache2` such that it restarts after a failure instead of just when it aborts, you can run the following:

```
sudo systemctl edit apache2
```

This will open a text editor containing:

```
Editing /etc/systemd/system/apache2.service.d/override.conf
Anything between here and the comment below will become the new contents of the file
```

```
Lines below this comment will be discarded
```

```
/lib/systemd/system/apache2.service
[Unit]
Description=The Apache HTTP Server
After=network.target remote-fs.target nss-lookup.target
Documentation=https://httpd.apache.org/docs/2.4/
#
[Service]
Type=forking
Environment=APACHE_STARTED_BY_SYSTEMD=true
ExecStart=/usr/sbin/apachectl start
ExecStop=/usr/sbin/apachectl graceful-stop
ExecReload=/usr/sbin/apachectl graceful
KillMode=mixed
PrivateTmp=true
Restart=on-abort
...
```

Override the `on-abort` option by adding a new line in the designated edit location.

```
Editing /etc/systemd/system/apache2.service.d/override.conf
Anything between here and the comment below will become the new contents of the file
```

```
[Service]
Restart=on-failure
```

```
Lines below this comment will be discarded
...
```

**Note:**

Some options, such as `ExecStart` are additive. If you would like to fully override them add an extra line that clears it (e.g. `ExecStart=`) before providing new options. See [Systemd's man page](#) for more information.

Once the changes are saved, the override file will be created in `/etc/systemd/system/apache2.service.d/override.conf`. To apply changes, run

```
sudo systemctl daemon-reload
```

To verify the change was successful, you can run the status command.

```
systemctl status apache2
```

```
● apache2.service - The Apache HTTP Server
 Loaded: loaded (/lib/systemd/system/apache2.service; enabled; preset: enabled)
 Drop-In: /etc/systemd/system/apache2.service.d
 └─override.conf
 /run/systemd/system/service.d
 └─zzz-lxc-service.conf
 Active: active (running) since Fri 2023-02-17 16:39:22 UTC; 27min ago
 Docs: https://httpd.apache.org/docs/2.4/
 Main PID: 4735 (apache2)
 Tasks: 55 (limit: 76934)
 Memory: 6.5M
 CPU: 65ms
 CGroup: /system.slice/apache2.service
 └─4735 /usr/sbin/apache2 -k start
 └─4736 /usr/sbin/apache2 -k start
 └─4737 /usr/sbin/apache2 -k start
...
```

## AppArmor

Packages that use [AppArmor](#) will install AppArmor profiles in the `/etc/apparmor.d/` directory. These files are often named after the process being protected, such as `usr.bin.firefox` and `usr.sbin.libvirtd`.

When these files are modified manually, it can lead to a conflict during updates. This will show up in `apt` with something like:

```
Configuration file '/etc/apparmor.d/usr.bin.swtpm'
==> Modified (by you or by a script) since installation.
==> Package distributor has shipped an updated version.
What would you like to do about it ? Your options are:
 Y or I : install the package maintainer's version
 N or O : keep your currently-installed version
 D : show the differences between the versions
 Z : start a shell to examine the situation
The default action is to keep your current version.
*** usr.bin.swtpm (Y/I/N/O/D/Z) [default=N] ?
```

Updating to the maintainer's version will override your changes, which could cause problems with your setup. However, using your version could cause security issues.

If you would like to modify these rules to provide the application with additional permissions, you can instead update the local profile, most often found in `/etc/apparmor.d/local/`.

For example, if you would like `swtpm` to access a custom directory called `/var/customtpm`, you can append the following line to `/etc/apparmor.d/local/usr.bin.swtpm` :

```
/var/customtpm/** rwk,
```

This method will work for all [AppArmor syntax](#).

**Note:**

Although most local profiles have the same name as the maintainer's, you can often check what file is

included based on the main profile's contents. In `swtprm`'s case, `/etc/apparmor.d/usr.bin.swtprm` contains the lines:

```
Site-specific additions and overrides. See local/README for details.
#include <local/usr.bin.swtprm>
```

showing that the local profile is located at `/etc/apparmor.d/local/usr.bin.swtprm`

## Restoring configuration files

Since config files are meant to be intentional changes by the user/admin, they are not overwritten by updates or even re-installs of the package. However, it's possible you might change it by accident or may just want to go back to step one of a trial-and-error phase that you are in. In those situations you can use `apt` to restore the original config files. Note that while we call `apt`, it is `dpkg` that actually handles the restoration.

If you have a particular config file, like in the example `/etc/rsyslog.conf`, you first want to find out which package owns that config file:

```
$ dpkg -S /etc/rsyslog.conf
```

```
rsyslog: /etc/rsyslog.conf
```

So we now know that the package `rsyslog` owns the config file `/etc/rsyslog.conf`.

This command just queries package metadata and works even if the file has been deleted.

```
$ rm /etc/rsyslog.conf
$ dpkg -S /etc/rsyslog.conf
```

```
rsyslog: /etc/rsyslog.conf
```

To restore that file you can re-install the package, telling `dpkg` to bring any missing files back.

To do so you pass `dpkg` options through `apt` using `-o Dpkg::Options::="--force-confmiss"` and then set `--force-...` depending on what action you want. For example:

```
$ sudo apt install --reinstall -o Dpkg::Options::="--force-confmiss" rsyslog
...
Preparing to unpack .../rsyslog_8.2302.0-1ubuntu3_amd64.deb ...
Unpacking rsyslog (8.2302.0-1ubuntu3) over (8.2302.0-1ubuntu3) ...
Setting up rsyslog (8.2302.0-1ubuntu3) ...
```

```
Configuration file '/etc/rsyslog.conf', does not exist on system.
Installing new config file as you requested.
```

More details on these options can be found in the [dpkg man page](#), but the most common and important ones are:

- `confmiss`  
Always install the missing conffile without prompting.
- `confnew`  
If a conffile has been modified and the version in the package changed, always install the new version without prompting.
- `confold`  
If a conffile has been modified and the version in the package changed, always keep the old version without prompting.
- `confdef`  
If a conffile has been modified and the version in the package changed, always choose the default action without prompting.
- `confask`  
If a conffile has been modified, always offer to replace it with the version in the package, even if the version in the package did not change.

So in the case of an accidental bad config entry, if you want to go back to the package default you could use `--force-confask` to check the difference and consider restoring the content.

```
$ echo badentry >> /etc/rsyslog.conf
$ sudo apt install --reinstall -o Dpkg::Options::="--force-confask" rsyslog
...
Preparing to unpack .../rsyslog_8.2302.0-1ubuntu3_amd64.deb ...
```

```
Unpacking rsyslog (8.2302.0-lubuntu3) over (8.2302.0-lubuntu3) ...
Setting up rsyslog (8.2302.0-lubuntu3) ...
```

```
Configuration file '/etc/rsyslog.conf'
==> Modified (by you or by a script) since installation.
 Version in package is the same as at last installation.
 What would you like to do about it ? Your options are:
 Y or I : install the package maintainer's version
 N or O : keep your currently-installed version
 D : show the differences between the versions
 Z : start a shell to examine the situation
 The default action is to keep your current version.
*** rsyslog.conf (Y/I/N/O/D/Z) [default=N] ? D
--- /etc/rsyslog.conf 2023-04-18 07:11:50.427040350 +0000
+++ /etc/rsyslog.conf.dpkg-new 2023-02-23 16:58:03.000000000 +0000
@@ -51,4 +51,3 @@
 # Include all config files in /etc/rsyslog.d/
 #
 $IncludeConfig /etc/rsyslog.d/*.conf
-badentry
```

```
Configuration file '/etc/rsyslog.conf'
==> Modified (by you or by a script) since installation.
 Version in package is the same as at last installation.
 What would you like to do about it ? Your options are:
 Y or I : install the package maintainer's version
 N or O : keep your currently-installed version
 D : show the differences between the versions
 Z : start a shell to examine the situation
 The default action is to keep your current version.
*** rsyslog.conf (Y/I/N/O/D/Z) [default=N] ? y
Installing new version of config file /etc/rsyslog.conf ...
```

The same can be used if you removed a whole directory by accident, to detect and re-install all related packages config files.

```
$ rm -rf /etc/vim
$ dpkg -S /etc/vim
vim-common, vim-tiny: /etc/vim
$ sudo apt install --reinstall -o Dpkg::Options::="--force-confmiss" vim-common vim-tiny
...
Configuration file '/etc/vim/vimrc', does not exist on system.
Installing new config file as you requested.
...
Configuration file '/etc/vim/vimrc.tiny', does not exist on system.
Installing new config file as you requested.
```

Networks consist of two or more devices, such as computer systems, printers, and related equipment, which are connected by either physical cabling or wireless links for the purpose of sharing and distributing information among the connected devices.

This section provides general and specific information pertaining to networking, including an overview of network concepts and detailed discussion of popular network protocols.

## The Transmission Control Protocol and Internet Protocol (TCP/IP)

The Transmission Control Protocol and Internet Protocol is a standard set of protocols developed in the late 1970s by the Defense Advanced Research Projects Agency (DARPA) as a means of communication between different types of computers and computer networks. TCP/IP is the driving force of the Internet, and thus it is the most popular set of network protocols on Earth.

### TCP/IP overview

The two protocol components of TCP/IP deal with different aspects of computer networking.

- **Internet Protocol** – the “IP” of TCP/IP – is a connectionless protocol that deals only with network packet routing using the *IP Datagram* as the basic unit of networking information. The IP Datagram consists of a header followed by a message.
- **Transmission Control Protocol** – the “TCP” of TCP/IP – enables network hosts to establish connections that may be used to exchange data streams. TCP also guarantees that data sent between connections is delivered, and that it arrives at one network host in the same order as sent from another network host.

## TCP/IP configuration

The TCP/IP protocol configuration consists of several elements that must be set by editing the appropriate configuration files, or by deploying solutions such as the Dynamic Host Configuration Protocol (DHCP) server which can, in turn, be configured to provide the proper TCP/IP configuration settings to network clients automatically. These configuration values must be set correctly in order to facilitate the proper network operation of your Ubuntu system.

The common configuration elements of TCP/IP and their purposes are as follows:

- **IP address:** The IP address is a unique identifying string expressed as four decimal numbers ranging from zero (0) to two-hundred and fifty-five (255), separated by periods, with each of the four numbers representing eight (8) bits of the address for a total length of thirty-two (32) bits for the whole address. This format is called *dotted quad notation*.
- **Netmask:** The subnet mask (or simply, *netmask*) is a local bit mask, or set of flags, which separate the portions of an IP address significant to the network from the bits significant to the *subnetwork*. For example, in a Class C network, the standard netmask is 255.255.255.0 which masks the first three bytes of the IP address and allows the last byte of the IP address to remain available for specifying hosts on the subnetwork.
- **Network address:** The network address represents the bytes comprising the network portion of an IP address. For example, the host 12.128.1.2 in a Class A network would use 12.0.0.0 as the network address, where twelve (12) represents the first byte of the IP address, (the network part) and zeroes (0) in all of the remaining three bytes to represent the potential host values. A network host using the private IP address 192.168.1.100 would in turn use a network address of 192.168.1.0, which specifies the first three bytes of the Class C 192.168.1 network and a zero (0) for all the possible hosts on the network.
- **Broadcast address:** The broadcast address is an IP address that allows network data to be sent simultaneously to all hosts on a given subnetwork, rather than specifying a particular host. The standard general broadcast address for IP networks is 255.255.255.255, but this broadcast address cannot be used to send a broadcast message to every host on the Internet because routers block it. A more appropriate broadcast address is set to match a specific subnetwork. For example, on the private Class C IP network, 192.168.1.0, the broadcast address is 192.168.1.255. Broadcast messages are typically produced by network protocols such as the Address Resolution Protocol (ARP) and the Routing Information Protocol (RIP).
- **Gateway address:** A gateway address is the IP address through which a particular network, or host on a network, may be reached. If one network host wishes to communicate with another network host, and that host is not located on the same network, then a *gateway* must be used. In many cases, the gateway address will be that of a router on the same network, which will in turn pass traffic on to other networks or hosts, such as Internet hosts. The value of the Gateway Address setting must be correct, or your system will not be able to reach any hosts beyond those on the same network.
- **Nameserver address:** Nameserver addresses represent the IP addresses of Domain Name Service (DNS) systems, which resolve network hostnames into IP addresses. There are three levels of nameserver addresses, which may be specified in order of precedence: The *primary* nameserver, the *secondary* nameserver, and the *tertiary* nameserver. So that your system can resolve network hostnames into their corresponding IP addresses, you must specify valid nameserver addresses that you are authorized to use in your system’s TCP/IP configuration. In many cases, these addresses can and will be provided by your network service provider, but many free and publicly accessible nameservers are available for use, such as the Level3 (Verizon) servers with IP addresses from 4.2.2.1 to 4.2.2.6.

### Tip

The IP address, netmask, network address, broadcast address, gateway address, and nameserver addresses are typically specified via the appropriate directives in the file `/etc/network/interfaces`. For more information, view the system manual page for `interfaces`, with the following command typed at a terminal prompt:

```
man interfaces
```

## IP routing

IP routing is a way of specifying and discovering paths in a TCP/IP network that network data can be sent along. Routing uses a set of *routing tables* to direct the forwarding of network data packets from their source to the destination, often via many intermediary network nodes known as *routers*. There are two primary forms of IP routing: *static routing* and *dynamic routing*.

Static routing involves manually adding IP routes to the system's routing table, and this is usually done by manipulating the routing table with the `route` command. Static routing enjoys many advantages over dynamic routing, such as simplicity of implementation on smaller networks, predictability (the routing table is always computed in advance, and thus the route is precisely the same each time it is used), and low overhead on other routers and network links due to the lack of a dynamic routing protocol. However, static routing does present some disadvantages as well. For example, static routing is limited to small networks and does not scale well. Static routing also fails completely to adapt to network outages and failures along the route due to the fixed nature of the route.

Dynamic routing depends on large networks with multiple possible IP routes from a source to a destination and makes use of special routing protocols, such as the Router Information Protocol (RIP), which handle the automatic adjustments in routing tables that make dynamic routing possible. Dynamic routing has several advantages over static routing, such as superior scalability and the ability to adapt to failures and outages along network routes. Additionally, there is less manual configuration of the routing tables, since routers learn from one another about their existence and available routes. This trait also prevents mistakes being introduced into the routing tables via human error. Dynamic routing is not perfect, however, and presents disadvantages such as heightened complexity and additional network overhead from router communications, which does not immediately benefit the end users but still consumes network bandwidth.

## About TCP and UDP

TCP (Transmission Control Protocol) and UDP (User Datagram Protocol) are the most common protocols used to transfer data over networks.

TCP is a connection-based protocol, offering error correction and guaranteed delivery of data via what is known as *flow control*. Flow control determines when the flow of a data stream needs to be stopped, and previously-sent data packets should be re-sent due to problems such as *collisions*, for example, thus ensuring complete and accurate delivery of the data. TCP is typically used in the exchange of important information such as database transactions.

UDP on the other hand, is a *connectionless* protocol which seldom deals with the transmission of important data because it lacks flow control or any other method to ensure reliable delivery of the data. UDP is commonly used in such applications as audio and video streaming, where it is considerably faster than TCP due to the lack of error correction and flow control, and where the loss of a few packets is not generally catastrophic.

## Internet Control Messaging Protocol (ICMP)

The Internet Control Messaging Protocol is an extension to the Internet Protocol (IP) as defined in the [Request For Comments \(RFC\) #792](#), and supports network packets containing control, error, and informational messages. ICMP is used by such network applications as the ping utility, which can determine the availability of a network host or device. Examples of some error messages returned by ICMP which are useful to both network hosts and devices such as routers, include *Destination Unreachable* and *Time Exceeded*.

## About daemons

Daemons are special system applications which typically execute continuously in the background and await requests for the functions they provide from other applications. Many daemons are network-centric; that is, a large number of daemons executing in the background on an Ubuntu system may provide network-related functionality. Such network daemons include the *Hyper Text Transport Protocol Daemon (httpd)*, which provides web server functionality; the *Secure SHell Daemon (sshd)*, which provides secure remote login shell and file transfer capabilities; and the *Internet Message Access Protocol Daemon (imapd)*, which provides E-Mail services.

## Resources

- There are man pages for [TCP](#) and [IP](#) that contain more useful information.
- Also, see the [TCP/IP Tutorial and Technical Overview](#) IBM Redbook.
- Another resource is O'Reilly's [TCP/IP Network Administration](#).

Ubuntu ships with a number of graphical utilities to configure your network devices. This document is geared toward server administrators and will focus on managing your network on the command line.

## Ethernet interfaces

Ethernet interfaces are identified by the system using predictable network interface names. These names can appear as *eno1* or *enp0s25*. However, in some cases an interface may still use the kernel *eth#* style of naming.

### Identify Ethernet interfaces

To quickly identify all available Ethernet interfaces, you can use the `ip` command as shown below.

```
ip a
1: lo: <LOOPBACK,UP,LOWER_UP> mtu 65536 qdisc noqueue state UNKNOWN group default qlen 1000
 link/loopback 00:00:00:00:00:00 brd 00:00:00:00:00:00
 inet 127.0.0.1/8 scope host lo
 valid_lft forever preferred_lft forever
 inet6 ::1/128 scope host
 valid_lft forever preferred_lft forever
2: enp0s25: <BROADCAST,MULTICAST,UP,LOWER_UP> mtu 1500 qdisc noqueue state UP group default qlen 1000
 link/ether 00:16:3e:e2:52:42 brd ff:ff:ff:ff:ff:ff link-netnsid 0
 inet 10.102.66.200/24 brd 10.102.66.255 scope global dynamic eth0
 valid_lft 3257sec preferred_lft 3257sec
 inet6 fe80::216:3eff:fee2:5242/64 scope link
 valid_lft forever preferred_lft forever
```

Another application that can help identify all network interfaces available to your system is the `lshw` command. This command provides greater details around the hardware capabilities of specific adapters. In the example below, `lshw` shows a single Ethernet interface with the logical name of *eth4* along with bus information, driver details and all supported capabilities.

```
sudo lshw -class network
*-network
 description: Ethernet interface
 product: MT26448 [ConnectX EN 10GigE, PCIe 2.0 5GT/s]
 vendor: Mellanox Technologies
 physical id: 0
 bus info: pci@0004:01:00.0
 logical name: eth4
 version: b0
 serial: e4:1d:2d:67:83:56
 slot: U78CB.001.WZS09KB-P1-C6-T1
 size: 10Gbit/s
 capacity: 10Gbit/s
 width: 64 bits
 clock: 33MHz
 capabilities: pm vpd msix pciexpress bus_master cap_list ethernet physical fibre 10000bt-fd
 configuration: autonegotiation=off broadcast=yes driver=mlx4_en driverversion=4.0-0 duplex=full firmware=2.9.1326 i
 resources: iomemory:24000-23fff irq:481 memory:3fe200000000-3fe2000fffff memory:240000000000-
240007fffff
```

### Ethernet Interface logical names

Interface logical names can also be configured via a Netplan configuration. If you would like control which interface receives a particular logical name use the `match` and `set-name` keys. The `match` key is used to find an adapter based on some criteria like MAC address, driver, etc. The `set-name` key can be used to change the device to the desired logical name.

```
network:
 version: 2
 renderer: networkd
 ethernets:
 eth_lan0:
 dhcp4: true
 match:
 macaddress: 00:11:22:33:44:55
 set-name: eth_lan0
```



## Ethernet Interface settings

ethtool is a program that displays and changes Ethernet card settings such as auto-negotiation, port speed, duplex mode, and Wake-on-LAN. The following is an example of how to view the supported features and configured settings of an Ethernet interface.

```
sudo ethtool eth4
Settings for eth4:
 Supported ports: [FIBRE]
 Supported link modes: 10000baseT/Full
 Supported pause frame use: No
 Supports auto-negotiation: No
 Supported FEC modes: Not reported
 Advertised link modes: 10000baseT/Full
 Advertised pause frame use: No
 Advertised auto-negotiation: No
 Advertised FEC modes: Not reported
 Speed: 10000Mb/s
 Duplex: Full
 Port: FIBRE
 PHYAD: 0
 Transceiver: internal
 Auto-negotiation: off
 Supports Wake-on: d
 Wake-on: d
 Current message level: 0x00000014 (20)
 link ifdown
 Link detected: yes
```

## IP addressing

The following section describes the process of configuring your system's IP address and default gateway needed for communicating on a local area network and the Internet.

### Temporary IP address assignment

For temporary network configurations, you can use the `ip` command which is also found on most other GNU/Linux operating systems. The `ip` command allows you to configure settings which take effect immediately – however they are not persistent and will be lost after a reboot.

To temporarily configure an IP address, you can use the `ip` command in the following manner. Modify the IP address and subnet mask to match your network requirements.

```
sudo ip addr add 10.102.66.200/24 dev enp0s25
```

The `ip` can then be used to set the link up or down.

```
ip link set dev enp0s25 up
ip link set dev enp0s25 down
```

To verify the IP address configuration of `enp0s25`, you can use the `ip` command in the following manner:

```
ip address show dev enp0s25
10: enp0s25: <BROADCAST,MULTICAST,UP,LOWER_UP> mtu 1500 qdisc noqueue state UP group default qlen 1000
 link/ether 00:16:3e:e2:52:42 brd ff:ff:ff:ff:ff:ff link-netnsid 0
 inet 10.102.66.200/24 brd 10.102.66.255 scope global dynamic eth0
 valid_lft 2857sec preferred_lft 2857sec
 inet6 fe80::216:3eff:fee2:5242/64 scope link
 valid_lft forever preferred_lft forever6
```

To configure a default gateway, you can use the `ip` command in the following manner. Modify the default gateway address to match your network requirements.

```
sudo ip route add default via 10.102.66.1
```

You can also use the `ip` command to verify your default gateway configuration, as follows:

```
ip route show
default via 10.102.66.1 dev eth0 proto dhcp src 10.102.66.200 metric 100
```

```
10.102.66.0/24 dev eth0 proto kernel scope link src 10.102.66.200
10.102.66.1 dev eth0 proto dhcp scope link src 10.102.66.200 metric 100
```

If you require DNS for your temporary network configuration, you can add DNS server IP addresses in the file `/etc/resolv.conf`. In general, editing `/etc/resolv.conf` directly is not recommended, but this is a temporary and non-persistent configuration. The example below shows how to enter two DNS servers to `/etc/resolv.conf`, which should be changed to servers appropriate for your network. A more lengthy description of the proper (persistent) way to do DNS client configuration is in a following section.

```
nameserver 8.8.8.8
nameserver 8.8.4.4
```

If you no longer need this configuration and wish to purge all IP configuration from an interface, you can use the `ip` command with the `flush` option:

```
ip addr flush eth0
```

#### Note

Flushing the IP configuration using the `ip` command does not clear the contents of `/etc/resolv.conf`. You must remove or modify those entries manually (or re-boot), which should also cause `/etc/resolv.conf`, which is a symlink to `/run/systemd/resolve/stub-resolv.conf`, to be re-written.

### Dynamic IP address assignment (DHCP client)

To configure your server to use DHCP for dynamic address assignment, create a Netplan configuration in the file `/etc/netplan/99_config.yaml`. The following example assumes you are configuring your first Ethernet interface identified as `enp3s0`.

```
network:
 version: 2
 renderer: networkd
 ethernets:
 enp3s0:
 dhcp4: true
```

The configuration can then be applied using the `netplan` command:

```
sudo netplan apply
```

### Static IP address assignment

To configure your system to use static address assignment, create a `netplan` configuration in the file `/etc/netplan/99_config.yaml`. The example below assumes you are configuring your first Ethernet interface identified as `eth0`. Change the `addresses`, `routes`, and `nameservers` values to meet the requirements of your network.

```
network:
 version: 2
 renderer: networkd
 ethernets:
 eth0:
 addresses:
 - 10.10.10.2/24
 routes:
 - to: default
 via: 10.10.10.1
 nameservers:
 search: [mydomain, otherdomain]
 addresses: [10.10.10.1, 1.1.1.1]
```

The configuration can then be applied using the `netplan` command.

```
sudo netplan apply
```

#### NOTE

`netplan` in Ubuntu Bionic 18.04 LTS doesn't understand the `"to: default"` syntax to specify a default route, and should use the older `gateway4: 10.10.10.1` key instead of the whole `routes: block`.

The loopback interface is identified by the system as `lo` and has a default IP address of `127.0.0.1`. It can be viewed using the `ip` command.

```

ip address show lo
1: lo: <LOOPBACK,UP,LOWER_UP> mtu 65536 qdisc noqueue state UNKNOWN group default qlen 1000
 link/loopback 00:00:00:00:00:00 brd 00:00:00:00:00:00
 inet 127.0.0.1/8 scope host lo
 valid_lft forever preferred_lft forever
 inet6 ::1/128 scope host
 valid_lft forever preferred_lft forever

```

## Name resolution

Name resolution (as it relates to IP networking) is the process of mapping hostnames to IP addresses, and vice-versa, making it easier to identify resources on a network. The following section will explain how to properly configure your system for name resolution using DNS and static hostname records.

### DNS client configuration

Traditionally, the file `/etc/resolv.conf` was a static configuration file that rarely needed to be changed, or it automatically changed via DHCP client hooks. `systemd-resolved` handles nameserver configuration, and it should be interacted with through the `systemd-resolve` command. Netplan configures `systemd-resolved` to generate a list of nameservers and domains to put in `/etc/resolv.conf`, which is a symlink:

```
/etc/resolv.conf -> ../run/systemd/resolve/stub-resolv.conf
```

To configure the resolver, add the IP addresses of the appropriate nameservers for your network to the `netplan` configuration file. You can also add optional DNS suffix search-lists to match your network domain names. The resulting file might look like the following:

```

network:
 version: 2
 renderer: networkd
 ethernets:
 enp0s25:
 addresses:
 - 192.168.0.100/24
 routes:
 - to: default
 via: 192.168.0.1
 nameservers:
 search: [mydomain, otherdomain]
 addresses: [1.1.1.1, 8.8.8.8, 4.4.4.4]

```

The `search` option can also be used with multiple domain names so that DNS queries will be appended in the order in which they are entered. For example, your network may have multiple sub-domains to search; a parent domain of `example.com`, and two sub-domains, `sales.example.com` and `dev.example.com`.

If you have multiple domains you wish to search, your configuration might look like the following:

```

network:
 version: 2
 renderer: networkd
 ethernets:
 enp0s25:
 addresses:
 - 192.168.0.100/24
 routes:
 - to: default
 via: 192.168.0.1
 nameservers:
 search: [example.com, sales.example.com, dev.example.com]
 addresses: [1.1.1.1, 8.8.8.8, 4.4.4.4]

```

If you try to ping a host with the name `server1`, your system will automatically query DNS for its Fully Qualified Domain Name (FQDN) in the following order:

1. `server1.example.com`
2. `server1.sales.example.com`

### 3. server1.dev.example.com

If no matches are found, the DNS server will provide a result of *notfound* and the DNS query will fail.

## Static hostnames

Static hostnames are locally defined hostname-to-IP mappings located in the file `/etc/hosts`. Entries in the `hosts` file will have precedence over DNS by default. This means that if your system tries to resolve a hostname and it matches an entry in `/etc/hosts`, it will not attempt to look up the record in DNS. In some configurations, especially when Internet access is not required, servers that communicate with a limited number of resources can be conveniently set to use static hostnames instead of DNS.

The following is an example of a `hosts` file where a number of local servers have been identified by simple hostnames, aliases and their equivalent Fully Qualified Domain Names (FQDN's):

```
127.0.0.1 localhost
127.0.1.1 ubuntu-server
10.0.0.11 server1 server1.example.com vpn
10.0.0.12 server2 server2.example.com mail
10.0.0.13 server3 server3.example.com www
10.0.0.14 server4 server4.example.com file
```

### Note

In this example, notice that each of the servers were given aliases in addition to their proper names and FQDN's. *Server1* has been mapped to the name *vpn*, *server2* is referred to as *mail*, *server3* as *www*, and *server4* as *file*.

## Name Service Switch (NSS) configuration

The order in which your system selects a method of resolving hostnames to IP addresses is controlled by the Name Service Switch (NSS) configuration file `/etc/nsswitch.conf`. As mentioned in the previous section, typically static hostnames defined in the systems `/etc/hosts` file have precedence over names resolved from DNS. The following is an example of the line responsible for this order of hostname lookups in the file `/etc/nsswitch.conf`.

```
hosts: files mdns4_minimal [NOTFOUND=return] dns mdns4
```

- `files` first tries to resolve static hostnames located in `/etc/hosts`.
- `mdns4_minimal` attempts to resolve the name using Multicast DNS.
- `[NOTFOUND=return]` means that any response of `notfound` by the preceding `mdns4_minimal` process should be treated as authoritative and that the system should not try to continue hunting for an answer.
- `dns` represents a legacy unicast DNS query.
- `mdns4` represents a multicast DNS query.

To modify the order of these name resolution methods, you can simply change the `hosts:` string to the value of your choosing. For example, if you prefer to use legacy unicast DNS versus multicast DNS, you can change the string in `/etc/nsswitch.conf` as shown below:

```
hosts: files dns [NOTFOUND=return] mdns4_minimal mdns4
```

## Bridging multiple interfaces

Bridging is a more advanced configuration, but is very useful in multiple scenarios. One scenario is setting up a bridge with multiple network interfaces, then using a firewall to filter traffic between two network segments. Another scenario is using bridge on a system with one interface to allow virtual machines direct access to the outside network. The following example covers the latter scenario:

Configure the bridge by editing your `netplan` configuration found in `/etc/netplan/`, entering the appropriate values for your physical interface and network:

```
network:
 version: 2
 renderer: networkd
 ethernets:
 enp3s0:
 dhcp4: no
 bridges:
 br0:
```

```
dhcp4: yes
interfaces:
- enp3s0
```

Now apply the configuration to enable the bridge:

```
sudo netplan apply
```

The new bridge interface should now be up and running. The `brctl` provides useful information about the state of the bridge, controls which interfaces are part of the bridge, etc. See `man brctl` for more information.

## networkd-dispatcher for hook scripts

Users of the former `ifupdown` may be familiar with using hook scripts (e.g., pre-up, post-up) in their interfaces file. [Netplan configuration](#) does not currently support hook scripts in its configuration definition.

Instead, to achieve this functionality with the `networkd` renderer, users can use [networkd-dispatcher](#). The package provides both users and packages with hook points when specific network states are reached, to aid in reacting to network state.

### Note:

If you are on Desktop (not Ubuntu Server) the network is driven by Network Manager - in that case you need [NM Dispatcher scripts](#) instead.

The [Netplan FAQ](#) has a [great table](#) that compares event timings between `ifupdown/systemd-networkd/network-manager`.

It is important to be aware that these hooks run asynchronously; i.e. they will not block transition into another state.

The [Netplan FAQ](#) also has an [example](#) on converting an old `ifupdown` hook to `networkd-dispatcher`.

## Resources

- The [Ubuntu Wiki Network page](#) has links to articles covering more advanced network configuration.
- The [Netplan website](#) has additional [examples](#) and documentation.
- The [Netplan man page](#) has more information on Netplan.
- The [systemd-resolved man page](#) has more information on `systemd-resolved` service.
- For more information on *bridging* see the [netplan.io examples page](#)

The Dynamic Host Configuration Protocol (DHCP) is a network service that enables host computers to be automatically assigned settings from a server as opposed to manually configuring each network host. Computers configured to be DHCP clients have no control over the settings they receive from the DHCP server, and the configuration is transparent to the computer's user.

The most common settings provided by a DHCP server to DHCP clients include:

- IP address and netmask
- IP address of the default-gateway to use
- IP addresses of the DNS servers to use

However, a DHCP server can also supply configuration properties such as:

- Hostname
- Domain name
- Time server
- Print server

The advantage of using DHCP is that any changes to the network, such as a change in the DNS server address, only need to be changed at the DHCP server, and all network hosts will be reconfigured the next time their DHCP clients poll the DHCP server. As an added advantage, it is also easier to integrate new computers into the network, as there is no need to check for the availability of an IP address. Conflicts in IP address allocation are also reduced.

A DHCP server can provide configuration settings using the following methods:

## Manual allocation (MAC address)

This method uses DHCP to identify the unique hardware address of each network card connected to the network, and then supplies a static configuration each time the DHCP client makes a request to the DHCP server using that network device. This ensures that a particular address is assigned automatically to that network card, based on its MAC address.

## Dynamic allocation (address pool)

In this method, the DHCP server assigns an IP address from a pool of addresses (sometimes also called a range or scope) for a period of time (known as a lease) configured on the server, or until the client informs the server that it doesn't need the address anymore. This way, the clients receive their configuration properties dynamically and on a "first come, first served" basis. When a DHCP client is no longer on the network for a specified period, the configuration is expired and released back to the address pool for use by other DHCP clients. After the lease period expires, the client must renegotiate the lease with the server to maintain use of the same address.

## Automatic allocation

Using this method, the DHCP automatically assigns an IP address permanently to a device, selecting it from a pool of available addresses. Usually, DHCP is used to assign a temporary address to a client, but a DHCP server can allow an infinite lease time.

The last two methods can be considered "automatic" because in each case the DHCP server assigns an address with no extra intervention needed. The only difference between them is in how long the IP address is leased; in other words, whether a client's address varies over time.

Ubuntu makes two DHCP servers available:

- `isc-dhcp-server` (which installs `dhcpcd`, the dynamic host configuration protocol daemon)
- `isc-kea`.

**Note that although Ubuntu still supports `isc-dhcp-server`, [this software is no longer supported by its vendor](#).**

### isc-kea

`Kea` is the DHCP server which ISC developed to replace `isc-dhcp`. It is newer and designed for more modern network environments.

This section describes how to install and configure `isc-kea` in Ubuntu 23.04 or greater. For `isc-dhcp-server` instructions, skip to the next section.

### Install isc-kea

At a terminal prompt, enter the following command to install `isc-kea`:

```
sudo apt install kea
```

This will also install a few binary packages, including

- `kea-dhcp4-server`: The IPv4 DHCP server (the one we will configure in this guide).
- `kea-dhcp6-server`: The IPv6 DHCP server.
- `kea-ctrl-agent`: A REST API service for Kea.
- `kea-dhcp-ddns-server`: A Dynamic DNS service to update DNS based on DHCP lease events.

Since the `kea-ctrl-agent` service has some administrative rights to the Kea services, we need to ensure regular users are not allowed to use the API without permissions. Ubuntu does it by requiring user authentication to access the `kea-ctrl-agent` API service ([LP: #2007312 has more details on this](#)).

Therefore, the installation process described above will get a `debconf` "high" priority prompt with 3 options:

- no action (default);
- configure with a random password; or
- configure with a given password.

If there is no password, the `kea-ctrl-agent` will **not** start.

The password is expected to be in `/etc/kea/kea-api-password`, with ownership `root:_kea` and permissions `0640`. To change it, run `dpkg-reconfigure kea-ctrl-agent`

(which will present the same 3 options from above again), or just edit the file manually.

## Configure kea-dhcp4

The kea-dhcp4 service can be configured by editing `/etc/kea/kea-dhcp4.conf`.

Most commonly, what you want to do is let Kea assign an IP address from a pre-configured IP address pool. This can be done with settings as follows:

```
{
 "Dhcp4": {
 "interfaces-config": {
 "interfaces": ["eth4"]
 },
 "control-socket": {
 "socket-type": "unix",
 "socket-name": "/run/kea/kea4-ctrl-socket"
 },
 "lease-database": {
 "type": "memfile",
 "lfc-interval": 3600
 },
 "valid-lifetime": 600,
 "max-valid-lifetime": 7200,
 "subnet4": [
 {
 "id": 1,
 "subnet": "192.168.1.0/24",
 "pools": [
 {
 "pool": "192.168.1.150 - 192.168.1.200"
 }
],
 "option-data": [
 {
 "name": "routers",
 "data": "192.168.1.254"
 },
 {
 "name": "domain-name-servers",
 "data": "192.168.1.1, 192.168.1.2"
 },
 {
 "name": "domain-name",
 "data": "mydomain.example"
 }
]
 }
]
 }
}
```

This will result in the DHCP server listening on interface “eth4”, giving clients an IP address from the range 192.168.1.150–192.168.1.200. It will lease an IP address for 600 seconds if the client doesn’t ask for a specific time frame. Otherwise the maximum (allowed) lease will be 7200 seconds. The server will also “advise” the client to use 192.168.1.254 as the default-gateway and 192.168.1.1 and 192.168.1.2 as its DNS servers.

After changing the config file you can reload the server configuration through `kea-shell` with the following command (considering you have the `kea-ctrl-agent` running as described above):

```
kea-shell --host 127.0.0.1 --port 8000 --auth-user kea-api --auth-password $(cat /etc/kea/kea-api-password) -
-service dhcp4 config-reload
```

Then, press ctrl-d. The server should respond with

```
[{ "result": 0, "text": "Configuration successful." }]
```

meaning your configuration was received by the server.

The `kea-dhcp4-server` service logs should contain an entry similar to `DHCP4_DYNAMIC_RECONFIGURATION_SUCCESS` dynamic server reconfiguration succeeded with file: `/etc/kea/kea-dhcp4.conf` signaling that the server was successfully reconfigured.

You can read `kea-dhcp4-server` service logs with `journalctl`:

```
journalctl -u kea-dhcp4-server
```

Alternatively, instead of reloading the DHCP4 server configuration through `kea-shell`, you can restart the `kea-dhcp4-service` with

```
systemctl restart kea-dhcp4-server
```

## isc-dhcp-server

This section describes how to install and configure the `isc-dhcp-server`.

### Install isc-dhcp-server

At a terminal prompt, enter the following command to install `isc-dhcp-server`:

```
sudo apt install isc-dhcp-server
```

**Note:**

`dhcpd`'s messages are being sent to `syslog`. Look there for diagnostic messages.

### Configure isc-dhcp-server

You will probably need to change the default configuration by editing `/etc/dhcp/dhcpd.conf` to suit your needs and particular configuration.

Most commonly, what you want to do is assign an IP address randomly. This can be done with `/etc/dhcp/dhcpd.conf` settings as follows:

```
minimal sample /etc/dhcp/dhcpd.conf
default-lease-time 600;
max-lease-time 7200;

subnet 192.168.1.0 netmask 255.255.255.0 {
 range 192.168.1.150 192.168.1.200;
 option routers 192.168.1.254;
 option domain-name-servers 192.168.1.1, 192.168.1.2;
 option domain-name "mydomain.example";
}
```

This will result in the DHCP server giving clients an IP address from the range 192.168.1.150–192.168.1.200. It will lease an IP address for 600 seconds if the client doesn't ask for a specific time frame. Otherwise the maximum (allowed) lease will be 7200 seconds. The server will also “advise” the client to use 192.168.1.254 as the default-gateway and 192.168.1.1 and 192.168.1.2 as its DNS servers.

You also may need to edit `/etc/default/isc-dhcp-server` to specify the interfaces `dhcpd` should listen to.

```
INTERFACESv4="eth4"
```

After changing the config files you need to restart the `dhcpd` service:

```
sudo systemctl restart isc-dhcp-server.service
```

## References

- The [isc-dhcp-server Ubuntu Wiki](#) page has more information.
- For more `/etc/dhcp/dhcpd.conf` options see the [dhcpd.conf man page](#).
- [ISC dhcp-server](#)



- [ISC Kea Documentation](#)

Network Time Protocol (NTP) is a networking protocol for synchronising time over a network. Basically, a client requests the current time from a server, and uses it to set its own clock.

Behind this simple description, there is a lot of complexity. There are tiers of NTP servers, with the tier one NTP servers connected to atomic clocks, and tier two and three servers spreading the load of actually handling requests across the Internet.

The client software is also a lot more complex than you might think. It has to factor out communication delays and adjust the time in a way that does not upset all the other processes that run on the server. Luckily, all that complexity is hidden from you!

By default, Ubuntu uses `timedatectl/timesyncd` to synchronise time and users can optionally use `chrony` to serve the Network Time Protocol.

## Synchronising your system's time

Since Ubuntu 16.04, `timedatectl/timesyncd` (which are part of `systemd`) replace most of `ntpdate/ntp`.

`timesyncd` is available by default and replaces not only `ntpdate`, but also the client portion of `chrony` (formerly `ntpd`). So, on top of the one-shot action that `ntpdate` provided on boot and network activation, `timesyncd` now regularly checks and keeps your local time in sync. It also stores time updates locally, so that after reboots the time monotonically advances (if applicable).

If `chrony` is installed, `timedatectl` steps back to let `chrony` do the timekeeping. This ensures that no two time syncing services are fighting. While use of `ntp` is no longer recommended, this also still applies to `ntpd` being installed to retain any previous behavior/config that you had through an upgrade. However, it also implies that on an upgrade from a former release, `ntp/ntpdate` might still be installed and therefore renders the new `systemd`-based services disabled.

`ntpdate` is now considered deprecated in favor of `timedatectl` (or `chrony`) and is no longer installed by default. `timesyncd` will generally do the right thing keeping your time in sync, and `chrony` will help with more complex cases. But if you had one of a few known special `ntpdate` use cases, consider the following:

- If you require a one-shot sync, use: `chronyd -q`
- If you require a one-shot time check (without setting the time), use: `chronyd -Q`

## Configure `timedatectl` and `timesyncd`

The current status of time and time configuration via `timedatectl` and `timesyncd` can be checked with `timedatectl status`, which will produce output like this:

```

 Local time: Fr 2018-02-23 08:47:13 UTC
 Universal time: Fr 2018-02-23 08:47:13 UTC
 RTC time: Fr 2018-02-23 08:47:13
 Time zone: Etc/UTC (UTC, +0000)
 System clock synchronized: yes
 systemd-timesyncd.service active: yes
 RTC in local TZ: no

```

If `chrony` is running it will automatically switch to:

```

[...]
systemd-timesyncd.service active: no

```

By using `timedatectl`, an admin can control the timezone, how the system clock should relate to the `hwclock` and whether permanent synchronisation should be enabled. See `man timedatectl` for more details.

`timesyncd` itself is still a normal service, so you can check its status in more detail using:

```
systemctl status systemd-timesyncd
```

The output produced will look something like this:

```

systemd-timesyncd.service - Network Time Synchronization
 Loaded: loaded (/lib/systemd/system/systemd-timesyncd.service; enabled; vendor preset: enabled)
 Active: active (running) since Fri 2018-02-23 08:55:46 UTC; 10s ago
 Docs: man:systemd-timesyncd.service(8)
 Main PID: 3744 (systemd-timesyn)
 Status: "Synchronized to time server 91.189.89.198:123 (ntp.ubuntu.com)."
```

```
CGroup: /system.slice/systemd-timesyncd.service
|-3744 /lib/systemd/systemd-timesyncd
```

```
Feb 23 08:55:46 bionic-test systemd[1]: Starting Network Time Synchronization...
Feb 23 08:55:46 bionic-test systemd[1]: Started Network Time Synchronization.
Feb 23 08:55:46 bionic-test systemd-timesyncd[3744]: Synchronized to time server 91.189.89.198:123 (ntp.ubuntu.com).
```

The server from which to fetch time for `timedatectl` and `timesyncd` can be specified in `/etc/systemd/timesyncd.conf`. Additional config files can be stored in `/etc/systemd/timesyncd.conf.d/`. The entries for `NTP=` and `FallbackNTP=` are space-separated lists. See `man timesyncd.conf` for more details.

## Serve the Network Time Protocol

In addition to synchronising your system, if you also want to serve NTP information then you need an NTP server. Between `chrony`, `ntpd` and `open-ntp` there are plenty of options, but the recommended solution is `chrony`.

### chronyd, the NTP daemon

The NTP daemon `chronyd` calculates the drift and offset of your system clock and continuously adjusts it, so there are no large corrections that could lead to inconsistent logs, for instance. The cost is a little processing power and memory, but for a modern server this is usually negligible.

### Install chronyd

To install `chrony`, run the following command from a terminal prompt:

```
sudo apt install chrony
```

This will provide two binaries:

- `chronyd` - the actual daemon to sync and serve via the Network Time Protocol
- `chronyc` - command-line interface for `chrony` daemon

### Configure chronyd

Firstly, edit `/etc/chrony/chrony.conf` to add/remove server lines. By default these servers are configured:

```
Use servers from the NTP Pool Project. Approved by Ubuntu Technical Board
on 2011-02-08 (LP: #104525). See http://www.pool.ntp.org/join.html for
more information.
pool 0.ubuntu.pool.ntp.org iburst
pool 1.ubuntu.pool.ntp.org iburst
pool 2.ubuntu.pool.ntp.org iburst
pool 3.ubuntu.pool.ntp.org iburst
```

See `man chrony.conf` for more details on the configuration options available. After changing any part of the config file you need to restart `chrony`, as follows:

```
sudo systemctl restart chrony.service
```

Of the pool, `2.ubuntu.pool.ntp.org` and `ntp.ubuntu.com` also support IPv6, if needed. If you need to force IPv6, there is also `ipv6.ntp.ubuntu.com` which is not configured by default.

## Enable serving the Network Time Protocol

You can install `chrony` (above) and configure special Hardware (below) for a local synchronisation and as-installed that is the default to stay on the secure and conservative side. But if you want to *serve* NTP you need adapt your configuration.

To enable serving NTP you'll need to at least set the `allow` rule. This controls which clients/networks you want `chrony` to serve NTP to.

An example would be:

```
allow 1.2.3.4
```

See the section "NTP server" in the [man page](#) for more details on how you can control and restrict access to your NTP server.

## View status

You can use `chronyc` to see query the status of the chrony daemon. For example, to get an overview of the currently available and selected time sources, run `chronyc sources`, which provides output like this:

```
MS Name/IP address Stratum Poll Reach LastRx Last sample
=====
^+ gamma.rueckgr.at 2 8 377 135 -1048us[-1048us] +/- 29ms
^- 2b.ncomputers.org 2 8 377 204 -1141us[-1124us] +/- 50ms
^+ www.kashra.com 2 8 377 139 +3483us[+3483us] +/- 18ms
^+ stratum2-4.NTP.TechFak.U> 2 8 377 143 -2090us[-2073us] +/- 19ms
^- zepto.mcl.gg 2 7 377 9 -774us[-774us] +/- 29ms
^- mirrorhost.pw 2 7 377 78 -660us[-660us] +/- 53ms
^- atto.mcl.gg 2 7 377 8 -823us[-823us] +/- 50ms
^- static.140.107.46.78.cli> 2 8 377 9 -1503us[-1503us] +/- 45ms
^- 4.53.160.75 2 8 377 137 -11ms[-11ms] +/- 117ms
^- 37.44.185.42 3 7 377 10 -3274us[-3274us] +/- 70ms
^- bagnikita.com 2 7 377 74 +3131us[+3131us] +/- 71ms
^- europa.ellipse.net 2 8 377 204 -790us[-773us] +/- 97ms
^- tethys.hot-chilli.net 2 8 377 141 -797us[-797us] +/- 59ms
^- 66-232-97-8.static.hvvc.> 2 7 377 206 +1669us[+1686us] +/- 133ms
^+ 85.199.214.102 1 8 377 205 +175us[+192us] +/- 12ms
^* 46-243-26-34.tangos.nl 1 8 377 141 -123us[-106us] +/- 10ms
^- pugot.canonical.com 2 8 377 21 -95us[-95us] +/- 57ms
^- alphyn.canonical.com 2 6 377 23 -1569us[-1569us] +/- 79ms
^- golem.canonical.com 2 7 377 92 -1018us[-1018us] +/- 31ms
^- chilipepper.canonical.com 2 8 377 21 -1106us[-1106us] +/- 27ms
```

You can also make use of the `chronyc sourcestats` command, which produces output like this:

```
210 Number of sources = 20
Name/IP Address NP NR Span Frequency Freq Skew Offset Std Dev
=====
gamma.rueckgr.at 25 15 32m -0.007 0.142 -878us 106us
2b.ncomputers.org 26 16 35m -0.132 0.283 -1169us 256us
www.kashra.com 25 15 32m -0.092 0.259 +3426us 195us
stratum2-4.NTP.TechFak.U> 25 14 32m -0.018 0.130 -2056us 96us
zepto.mcl.gg 13 11 21m +0.148 0.196 -683us 66us
mirrorhost.pw 6 5 64s +0.117 0.445 -591us 19us
atto.mcl.gg 21 13 25m -0.069 0.199 -904us 103us
static.140.107.46.78.cli> 25 18 34m -0.005 0.094 -1526us 78us
4.53.160.75 25 10 32m +0.412 0.110 -11ms 84us
37.44.185.42 24 12 30m -0.983 0.173 -3718us 122us
bagnikita.com 17 7 31m -0.132 0.217 +3527us 139us
europa.ellipse.net 26 15 35m +0.038 0.553 -473us 424us
tethys.hot-chilli.net 25 11 32m -0.094 0.110 -864us 88us
66-232-97-8.static.hvvc.> 20 11 35m -0.116 0.165 +1561us 109us
85.199.214.102 26 11 35m -0.054 0.390 +129us 343us
46-243-26-34.tangos.nl 25 16 32m +0.129 0.297 -307us 198us
pugot.canonical.com 25 14 34m -0.271 0.176 -143us 135us
alphyn.canonical.com 17 11 1100 -0.087 0.360 -1749us 114us
golem.canonical.com 23 12 30m +0.057 0.370 -988us 229us
chilipepper.canonical.com 25 18 34m -0.084 0.224 -1116us 169us
```

Certain `chronyc` commands are privileged and cannot be run via the network without explicitly allowing them. See the *Command and monitoring access* section in `man chrony.conf` for more details. A local admin can use `sudo` since this will grant access to the local admin socket `/var/run/chrony/chronyd.sock`.

## Pulse-Per-Second (PPS) support

Chrony supports various PPS types natively. It can use kernel PPS API as well as Precision Time Protocol (PTP) hardware clocks. Most general GPS receivers can be leveraged via GPSD. The latter (and potentially more) can be accessed via *SHM* or via a *socket* (recommended). All of the above can be used to augment chrony with additional high quality time sources for better accuracy, jitter, drift, and longer- or shorter-term accuracy. Usually, each kind of clock type is good at one of those, but non-perfect at the others. For more details on configuration see some of the external PPS/GPSD resources listed below.

**Note:**

As of the release of 20.04, there was a bug which - until fixed - you might want to [add this content](#) to your `/etc/apparmor.d/local/usr.sbin.gpsd`.

**Example configuration for GPSD to feed Chrony**

For the installation and setup you will first need to run the following command in your terminal window:

```
sudo apt install gpsd chrony
```

However, since you will want to test/debug your setup (especially the GPS reception), you should also install:

```
sudo apt install pps-tools gpsd-clients
```

GPS devices usually communicate via serial interfaces. The most common type these days are USB GPS devices, which have a serial converter behind USB. If you want to use one of these devices for PPS then please be aware that the majority do not signal PPS via USB. Check the [GPSD hardware](#) list for details. The examples below were run with a Navisys GR701-W.

When plugging in such a device (or at boot time) `dmesg` should report a serial connection of some sort, as in this example:

```
[52.442199] usb 1-1.1: new full-speed USB device number 3 using xhci_hcd
[52.546639] usb 1-1.1: New USB device found, idVendor=067b, idProduct=2303, bcdDevice= 4.00
[52.546654] usb 1-1.1: New USB device strings: Mfr=1, Product=2, SerialNumber=0
[52.546665] usb 1-1.1: Product: USB-Serial Controller D
[52.546675] usb 1-1.1: Manufacturer: Prolific Technology Inc.
[52.602103] usbcore: registered new interface driver usbserial_generic
[52.602244] usbserial: USB Serial support registered for generic
[52.609471] usbcore: registered new interface driver pl2303
[52.609503] usbserial: USB Serial support registered for pl2303
[52.609564] pl2303 1-1.1:1.0: pl2303 converter detected
[52.618366] usb 1-1.1: pl2303 converter now attached to ttyUSB0
```

We see in this example that the device appeared as `ttyUSB0`. So that `chrony` later accepts being fed time information by this device, we have to set it up in `/etc/chrony/chrony.conf` (please replace `USB0` with whatever applies to your setup):

```
refclock SHM 0 refid GPS precision 1e-1 offset 0.9999 delay 0.2
refclock SOCK /var/run/chrony.ttyUSB0.sock refid PPS
```

Next, we need to restart `chrony` to make the socket available and have it waiting.

```
sudo systemctl restart chrony
```

We then need to tell `gpsd` which device to manage. Therefore, in `/etc/default/gpsd` we set:

```
DEVICES="/dev/ttyUSB0"
```

It should be noted that since the *default* use-case of `gpsd` is, well, for *gps position tracking*, it will normally not consume any CPU since it is just waiting on a *socket* for clients. Furthermore, the client will tell `gpsd` what it requests, and `gpsd` will only provide what is asked for.

For the use case of `gpsd` as a PPS-providing-daemon, you want to set the option to:

- Immediately start (even without a client connected). This can be set in `GPSD_OPTIONS` of `/etc/default/gpsd`:
 

```
– GPSD_OPTIONS="-n"
```
- Enable the service itself and not wait for a client to reach the socket in the future:
 

```
– sudo systemctl enable /lib/systemd/system/gpsd.service
```

Restarting `gpsd` will now initialize the PPS from GPS and in `dmesg` you will see:

```
pps_ldisc: PPS line discipline registered
pps pps0: new PPS source usbserial0
pps pps0: source "/dev/ttyUSB0" added
```

If you have multiple PPS sources, the tool `ppsfind` may be useful to help identify which PPS belongs to which GPS. In our example, the command `sudo ppsfind /dev/ttyUSB0` would return the following:

```
pps0: name=usbserial0 path=/dev/ttyUSB0
```

Now we have completed the basic setup. To proceed, we now need our GPS to get a lock. Tools like `cgps` or `gpsmon` need to report a 3D “fix” in order to provide accurate data. Let’s run the command `cgps`, which in our case returns:

```
...
| Status: 3D FIX (7 secs) ...
```

You would then want to use `ppstest` in order to check that you are really receiving PPS data. So, let us run the command `sudo ppstest /dev/pps0`, which will produce an output like this:

```
trying PPS source "/dev/pps0"
found PPS source "/dev/pps0"
ok, found 1 source(s), now start fetching data...
source 0 - assert 1588140739.099526246, sequence: 69 - clear 1588140739.999663721, sequence: 70
source 0 - assert 1588140740.099661485, sequence: 70 - clear 1588140739.999663721, sequence: 70
source 0 - assert 1588140740.099661485, sequence: 70 - clear 1588140740.999786664, sequence: 71
source 0 - assert 1588140741.099792447, sequence: 71 - clear 1588140740.999786664, sequence: 71
```

Ok, `gpsd` is now running, the GPS reception has found a fix, and it has fed this into `chrony`. Let’s check on that from the point of view of `chrony`.

Initially, before `gpsd` has started or before it has a lock, these sources will be new and “untrusted” - they will be marked with a “?” as shown in the example below. If your devices remain in the “?” state (even after some time) then `gpsd` is not feeding any data to `chrony` and you will need to debug why.

```
chronyc> sources
210 Number of sources = 10
MS Name/IP address Stratum Poll Reach LastRx Last sample
=====
#? GPS 0 4 0 - +0ns[+0ns] +/- 0ns
#? PPS 0 4 0 - +0ns[+0ns] +/- 0ns
```

Over time, `chrony` will classify all of the unknown sources as “good” or “bad”. In the example below, the raw GPS had too much deviation ( $\pm 200\text{ms}$ ) but the PPS is good ( $\pm 63\mu\text{s}$ ).

```
chronyc> sources
210 Number of sources = 10
MS Name/IP address Stratum Poll Reach LastRx Last sample
=====
#x GPS 0 4 177 24 -876ms[-876ms] +/- 200ms
#- PPS 0 4 177 21 +916us[+916us] +/- 63us
^- chilipepper.canonical.com 2 6 37 53 +33us[+33us] +/- 33ms
```

Finally, after a while it used the hardware PPS input (as it was better):

```
chronyc> sources
210 Number of sources = 10
MS Name/IP address Stratum Poll Reach LastRx Last sample
=====
#x GPS 0 4 377 20 -884ms[-884ms] +/- 200ms
#* PPS 0 4 377 18 +6677ns[+52us] +/- 58us
^- alphyn.canonical.com 2 6 377 20 -1303us[-1258us] +/- 114ms
```

The PPS might also be OK – but used in a combined way with the selected server, for example. See `man chronyc` for more details about how these combinations can look:

```
chronyc> sources
210 Number of sources = 11
MS Name/IP address Stratum Poll Reach LastRx Last sample
=====
#? GPS 0 4 0 - +0ns[+0ns] +/- 0ns
#+ PPS 0 4 377 22 +154us[+154us] +/- 8561us
^* chilipepper.canonical.com 2 6 377 50 -353us[-300us] +/- 44ms
```

If you’re wondering if your SHM-based GPS data is any good, you can check on that as well. `chrony` will not only tell you if the data is classified as good or bad – using `sourcestats` you can also check the details:

```
chronyc> sourcestats
210 Number of sources = 10
Name/IP Address NP NR Span Frequency Freq Skew Offset Std Dev
=====
```

GPS	20	9	302	+1.993	11.501	-868ms	1208us
PPS	6	3	78	+0.324	5.009	+3365ns	41us
golem.canonical.com	15	10	783	+0.859	0.509	-750us	108us

You can also track the raw data that `gpsd` or other `ntpd`-compliant reference clocks are sending via shared memory by using `ntpshmmon`. Let us run the command `sudo ntpshmmon -o`, which should provide the following output:

```
ntpshmmon: version 3.20
Name Offset Clock Real L Prc
sample NTP1 0.000223854 1588265805.000223854 1588265805.000000000 0 -10
sample NTP0 0.125691783 1588265805.125999851 1588265805.000308068 0 -20
sample NTP1 0.000349341 1588265806.000349341 1588265806.000000000 0 -10
sample NTP0 0.130326636 1588265806.130634945 1588265806.000308309 0 -20
sample NTP1 0.000485216 1588265807.000485216 1588265807.000000000 0 -10
```

## NTS Support

In Chrony 4.0 (which first appeared in Ubuntu 21.04 Hirsute) support for [Network Time Security](#) “NTS” was added.

### NTS server

To set up your server with NTS you’ll need certificates so that the server can authenticate itself and, based on that, allow the encryption and verification of NTP traffic.

In addition to the `allow` statement that any `chrony` (while working as an NTP server) needs there are two mandatory config entries that will be needed. Example certificates for those entries would look like:

```
ntsservercert /etc/chrony/fullchain.pem
ntsserverkey /etc/chrony/privkey.pem
```

It is important to note that for isolation reasons `chrony`, by default, runs as user and group `_chrony`. Therefore you need to grant access to the certificates for that user, by running the following command:

```
sudo chown _chrony:_chrony /etc/chrony/*.pem
```

Then restart `chrony` with `systemctl restart chrony` and it will be ready to provide NTS-based time services.

A running `chrony` server measures various statistics. One of them counts the number of NTS connections that were established (or dropped) – we can check this by running `sudo chronyc -N serverstats`, which shows us the statistics:

```
NTP packets received : 213
NTP packets dropped : 0
Command packets received : 117
Command packets dropped : 0
Client log records dropped: 0
NTS-KE connections accepted: 2
NTS-KE connections dropped: 0
Authenticated NTP packets : 197
```

There is also a per-client statistic which can be enabled by the `-p` option of the `clients` command.

```
sudo chronyc -N clients -k
```

This provides output in the following form:

Hostname	NTP	Drop	Int	IntL	Last	NTS-KE	Drop	Int	Last
10.172.196.173	197	0	10	-	595	2	0	5	48h
...									

For more complex scenarios there are many more advanced options for configuring NTS. These are documented in [the chrony man page](#).

#### **Note:** *About certificate placement*

`Chrony`, by default, is isolated via `AppArmor` and uses a number of `protect*` features of `systemd`. Due to that, there are not many paths `chrony` can access for the certificates. But `/etc/chrony/*` is allowed as read-only and that is enough.

Check `/etc/apparmor.d/usr.sbin.chronyd` if you want other paths or allow custom paths in `/etc/apparmor.d/local/usr.sbin`

## NTS client

The client needs to specify `server` as usual (`pool` directives do not work with NTS). Afterwards, the server address options can be listed and it is there that `nts` can be added. For example:

```
server <server-fqdn-or-IP> iburst nts
```

One can check the `authdata` of the connections established by the client using `sudo chronyc -N authdata`, which will provide the following information:

Name/IP address	Mode	KeyID	Type	KLen	Last	Atmp	NAK	Cook	CLen
<server-fqdn-or-ip>	NTS	1	15	256	48h	0	0	8	100

Again, there are more advanced options documented in [the man page](#). Common use cases are specifying an explicit trusted certificate.

### Bad Clocks and secure time syncing - “A Chicken and Egg” problem

There is one problem with systems that have very bad clocks. NTS is based on TLS, and TLS needs a reasonably correct clock. Due to that, an NTS-based sync might fail. On hardware affected by this problem, one can consider using the `nocerttimecheck` option which allows the user to set the number of times that the time can be synced without checking validation and expiration.

## References

- [Chrony FAQ](#)
- [ntp.org](#): home of the Network Time Protocol project
- [pool.ntp.org](#): project of virtual cluster of timeservers
- [Freedesktop.org](#) info on `timedatectl`
- [Freedesktop.org](#) info on `systemd-timesyncd` service
- [Feeding chrony from GPSD](#)
- See the [Ubuntu Time](#) wiki page for more information.

The DPDK is a set of libraries and drivers for fast packet processing, which runs mostly in Linux userland. This set of libraries provides the so-called “Environment Abstraction Layer” (EAL). The EAL hides the details of the environment and provides a standard programming interface. Common use cases are around special solutions, such as network function virtualisation and advanced high-throughput network switching.

The DPDK uses a run-to-completion model for fast data plane performance and accesses devices via polling to eliminate the latency of interrupt processing, albeit with the tradeoff of higher CPU consumption. It was designed to run on any processor. The first supported CPU was Intel x86 and it is now extended to IBM PPC64 and ARM64.

Ubuntu provides some additional infrastructure to increase DPDKs usability.

## Prerequisites

This package is currently compiled for the lowest possible CPU requirements allowed by upstream. Starting with [DPDK 17.08](#), that means it requires at least SSE4\_2 and for anything else activated by `-march=corei7` (in GCC) to be supported by the CPU.

The list of upstream DPDK-supported network cards can be found at [supported NICs](#). However, a lot of those are disabled by default in the upstream project as they are not yet in a stable state. The subset of network cards that DPDK has enabled in the package (as available in Ubuntu 16.04) is:

DPDK has “userspace” drivers for the cards called PMDs.

The packages for these follow the pattern of `librte-pmd-<type>-<version>`. Therefore the example for an Intel e1000 in 18.11 would be `librte-pmd-e1000-18.11`.

The more commonly used, tested and fully supported drivers are installed as dependencies of `dpdk`. But there are [many more](#) “in-universe” that follow the same naming pattern.

## Unassign the default kernel drivers

Cards must be unassigned from their kernel driver and instead be assigned to `uio_pci_generic` of `vfio-pci`. `uio_pci_generic` is older and it’s (usually) easier to get it to work. However, it also has fewer features and less

isolation.

The newer VFIO-PCI requires that you activate the following kernel parameters to enable the input-output memory management unit (IOMMU):

```
iommu=pt intel_iommu=on
```

Alternatively, on AMD:

```
amd_iommu=pt
```

On top of VFIO-PCI, you must also configure and assign the IOMMU groups accordingly. This is mostly done in firmware and by hardware layout – you can check the group assignment the kernel probed in `/sys/kernel/iommu_groups/`.

**Note:**

VirtIO is special. DPDK can directly work on these devices without `vfio_pci/uiso_pci_generic`. However, to avoid issues that might arise from the kernel and DPDK managing the device, you still need to unassign the kernel driver.

Manual configuration and status checks can be done via `sysfs`, or with the tool `dpdk_nic_bind`:

```
dpdk_nic_bind.py --help
```

## Usage

```
dpdk-devbind.py [options] DEVICE1 DEVICE2
```

where `DEVICE1`, `DEVICE2` etc, are specified via PCI "domain:bus:slot.func" syntax or "bus:slot.func" syntax. For devices bound to Linux kernel drivers, they may also be referred to by Linux interface name e.g. `eth0`, `eth1`, `em0`, `em1`, etc.

Options:

`--help`, `--usage`:

Display usage information and quit

`-s`, `--status`:

Print the current status of all known network, crypto, event and mempool devices.

For each device, it displays the PCI domain, bus, slot and function, along with a text description of the device. Depending upon whether the device is being used by a kernel driver, the `igb_uio` driver, or no driver, other relevant information will be displayed:

\* the Linux interface name e.g. `if=eth0`

\* the driver being used e.g. `drv=igb_uio`

\* any suitable drivers not currently using that device

e.g. `unused=igb_uio`

NOTE: if this flag is passed along with a bind/unbind option, the status display will always occur after the other operations have taken place.

`--status-dev`:

Print the status of given device group. Supported device groups are:

"net", "crypto", "event", "mempool" and "compress"

`-b driver`, `--bind=driver`:

Select the driver to use or "none" to unbind the device

`-u`, `--unbind`:

Unbind a device (Equivalent to `-b none`)

`--force`:

By default, network devices which are used by Linux - as indicated by having routes in the routing table - cannot be modified. Using the `--force` flag overrides this behavior, allowing active links to be forcibly unbound.

WARNING: This can lead to loss of network connection and should be used



with caution.

Examples:

-----

To display current device status:

```
dpdk-devbind.py --status
```

To display current network device status:

```
dpdk-devbind.py --status-dev net
```

To bind eth1 from the current driver and move to use igb\_uio

```
dpdk-devbind.py --bind=igb_uio eth1
```

To unbind 0000:01:00.0 from using any driver

```
dpdk-devbind.py -u 0000:01:00.0
```

To bind 0000:02:00.0 and 0000:02:00.1 to the ixgbe kernel driver

```
dpdk-devbind.py -b ixgbe 02:00.0 02:00.1
```

## DPDK device configuration

The package `dpdk` provides *init* scripts that ease configuration of device assignment and huge pages. It also makes them persistent across reboots.

The following is an example of the file `/etc/dpdk/interfaces` configuring two ports of a network card: one with `uio_pci_generic` and the other with `vfio-pci`.

```
<bus> Currently only "pci" is supported
<id> Device ID on the specified bus
<driver> Driver to bind against (vfio-pci or uio_pci_generic)
#
Be aware that the two DPDK compatible drivers uio_pci_generic and vfio-pci are
part of linux-image-extra-<VERSION> package.
This package is not always installed by default - for example in cloud-images.
So please install it in case you run into missing module issues.
#
<bus> <id> <driver>
pci 0000:04:00.0 uio_pci_generic
pci 0000:04:00.1 vfio-pci
```

Cards are identified by their PCI-ID. If you need to check, you can use the tool `dpdk_nic_bind.py` to show the currently available devices – and the drivers they are assigned to. For example, running the command `dpdk_nic_bind.py --status` provides the following details:

Network devices using DPDK-compatible driver

=====

```
0000:04:00.0 'Ethernet Controller 10-Gigabit X540-AT2' drv=uio_pci_generic unused=ixgbe
```

Network devices using kernel driver

=====

```
0000:02:00.0 'NetXtreme BCM5719 Gigabit Ethernet PCIe' if=eth0 drv=tg3 unused=uio_pci_generic *Active*
0000:02:00.1 'NetXtreme BCM5719 Gigabit Ethernet PCIe' if=eth1 drv=tg3 unused=uio_pci_generic
0000:02:00.2 'NetXtreme BCM5719 Gigabit Ethernet PCIe' if=eth2 drv=tg3 unused=uio_pci_generic
0000:02:00.3 'NetXtreme BCM5719 Gigabit Ethernet PCIe' if=eth3 drv=tg3 unused=uio_pci_generic
0000:04:00.1 'Ethernet Controller 10-Gigabit X540-AT2' if=eth5 drv=ixgbe unused=uio_pci_generic
```

Other network devices

=====

```
<none>
```

## DPDK hugepage configuration

DPDK makes heavy use of hugepages to eliminate pressure on the translation lookaside buffer (TLB). Therefore, hugepages need to be configured in your system. The `dpdk` package has a config file and scripts that try to ease

hugepage configuration for DPDK in the form of `/etc/dpdk/dpdk.conf`.

If you have more consumers of hugepages than just DPDK in your system – or very special requirements for how your hugepages will be set up – you likely want to allocate/control them yourself. If not, this can be a great simplification to get DPDK configured for your needs.

As an example, we can specify a configuration of 1024 hugepages of 2M each and four 1G pages in `/etc/dpdk/dpdk.conf` by adding:

```
NR_2M_PAGES=1024
NR_1G_PAGES=4
```

This supports configuring 2M and the larger 1G hugepages (or a mix of both). It will make sure there are proper `hugetlbfs` mountpoints for DPDK to find both sizes – no matter what size your default hugepage is. The config file itself holds more details on certain corner cases and a few hints if you want to allocate hugepages manually via a kernel parameter.

The size you want depends on your needs: 1G pages are certainly more effective regarding TLB pressure, but there have been reports of them fragmenting inside the DPDK memory allocations. Also, it can be harder to find enough free space to set up a certain number of 1G pages later in the life-cycle of a system.

## Compile DPDK applications

Currently, there are not many consumers of the DPDK library that are stable and released. Open vSwitch DPDK is an exception to that (see below) and more are appearing, but in general it may be that you will want to compile an app against the library.

You will often find guides that tell you to fetch the DPDK sources, build them to your needs and eventually build your application based on DPDK by setting values `RTE_*` for the build system. Since Ubuntu provides an already-compiled DPDK for you can skip all that.

DPDK provides a [valid pkg-config file](#) to simplify setting the proper variables and options:

```
sudo apt-get install dpdk-dev libdpdk-dev
gcc testdpdkprog.c $(pkg-config --libs --cflags libdpdk) -o testdpdkprog
```

An example of a complex (auto-configure) user of `pkg-config` of DPDK including fallbacks to older non `pkg-config` style can be seen in the [Open vSwitch build system](#).

Depending on what you are building, it may be a good idea to install all DPDK build dependencies before the make. On Ubuntu, this can be done automatically with the following command:

```
sudo apt-get install build-dep dpdk
```

## DPDK in KVM guests

Even if you have no access to DPDK-supported network cards, you can still work with DPDK by using its support for VirtIO. To do so, you must create guests backed by hugepages (see above). In addition, you will also need to have *at least* Streaming SIMD Extensions 3 (SSE3).

The default CPU model used by QEMU/libvirt is only up to SSE2. So, you will need to define a model that passes the proper feature flags (or use `host-passthrough`). As an example, you can add the following snippet to your virsh XML (or the equivalent virsh interface you use).

```
<cpu mode='host-passthrough'>
```

Nowadays, VirtIO supports multi-queue, which DPDK in turn can exploit for increased speed. To modify a normal VirtIO definition to have multiple queues, add the following snippet to your interface definition.

```
<driver name="vhost" queues="4"/>
```

This will enhance a normal VirtIO NIC to have multiple queues, which can later be consumed by e.g., DPDK in the guest.

## Use DPDK

Since DPDK itself is only a (massive) library, you most likely will continue to [Open vSwitch DPDK](#) as an example to put it to use.

## Resources

- [DPDK documentation](#)
- [Release Notes matching the version packages in Ubuntu 16.04](#)
- [Linux DPDK user getting started](#)
- [EAL command-line options](#)
- [DPDK API documentation](#)
- [Open vSwitch DPDK installation](#)
- [Wikipedia definition of DPDK](#)

Since DPDK is *just* a library, it doesn't do a lot on its own so it depends on emerging projects making use of it. One consumer of the library that is already part of Ubuntu is Open vSwitch with DPDK (OvS-DPDK) support in the package `openvswitch-switch-dpdk`.

Here is a brief example of how to install and configure a basic Open vSwitch using DPDK for later use via `libvirt/qemu-kvm`.

```
sudo apt-get install openvswitch-switch-dpdk
sudo update-alternatives --set ovs-vswitchd /usr/lib/openvswitch-switch-dpdk/ovs-vswitchd-dpdk
ovs-vsctl set Open_vSwitch . "other_config:dpdk-init=true"
run on core 0 only
ovs-vsctl set Open_vSwitch . "other_config:dpdk-lcore-mask=0x1"
Allocate 2G huge pages (not Numa node aware)
ovs-vsctl set Open_vSwitch . "other_config:dpdk-alloc-mem=2048"
limit to one whitelisted device
ovs-vsctl set Open_vSwitch . "other_config:dpdk-extra=--pci-whitelist=0000:04:00.0"
sudo service openvswitch-switch restart
```

### Remember:

You need to assign devices to DPDK-compatible drivers before restarting – see the DPDK section on [unassigning the default kernel drivers](#).

Please note that the section `_dpdk-alloc-mem=2048_` in the above example is the most basic non-uniform memory access (NUMA) setup for a single socket system. If you have multiple sockets you may want to define how the memory should be split among them. More details about these options are outlined in [Open vSwitch setup](#).

## Attach DPDK ports to Open vSwitch

The Open vSwitch you started above supports all the same port types as Open vSwitch usually does, *plus* DPDK port types. The following example shows how to create a bridge and – instead of a normal external port – add an external DPDK port to it. When doing so you can specify the associated device.

```
ovs-vsctl add-br ovsdpdkbr0 -- set bridge ovsdpdkbr0 datapath_type=netdev
ovs-vsctl add-port ovsdpdkbr0 dpdk0 -- set Interface dpdk0 type=dpdk "options:dpdk-devargs=${OVSEDEV_PCIID}"
```

You can tune this further by setting options:

```
ovs-vsctl set Interface dpdk0 "options:n_rxq=2"
```

## Open vSwitch DPDK to KVM guests

If you are not building some sort of software-defined networking (SDN) switch or NFV on top of DPDK, it is very likely that you want to forward traffic to KVM guests. The good news is; with the new `qemu/libvirt/dpdk/openvswitch` versions in Ubuntu this is no longer about manually appending a command line string. This section demonstrates a basic setup to connect a KVM guest to an Open vSwitch DPDK instance.

The recommended way to get to a KVM guest is using `vhost_user_client`. This will cause OvS-DPDK to connect to a socket created by QEMU. In this way, we can avoid old issues like “guest failures on OvS restart”. Here is an example of how to add such a port to the bridge you created above.

```
ovs-vsctl add-port ovsdpdkbr0 vhost-user-1 -- set Interface vhost-user-1 type=dpdkvhostuserclient "options:vhost-server-path=/var/run/vhostuserclient/vhost-user-client-1"
```

This will connect to the specified path that has to be created by a guest listening for it.

To let `libvirt/kvm` consume this socket and create a guest VirtIO network device for it, add the following snippet to your guest definition as the network definition.

```

<interface type='vhostuser'>
<source type='unix'
path='/var/run/vhostuserclient/vhost-user-client-1'
mode='server' />
<model type='virtio' />
</interface>

```

## Tuning Open vSwitch-DPDK

DPDK has plenty of options – in combination with Open vSwitch-DPDK the two most commonly used are:

```

ovs-vsctl set Open_vSwitch . other_config:n-dpdk-rxqs=2
ovs-vsctl set Open_vSwitch . other_config:pmd-cpu-mask=0x6

```

The first line selects how many Rx Queues are to be used for each DPDK interface, while the second controls how many poll mode driver (PMD) threads to run (and where to run them). The example above will use two Rx Queues, and run PMD threads on CPU 1 and 2.

### See also:

Check the links to “EAL Command-line Options” and “Open vSwitch DPDK installation” at the end of this document for more information.

As usual with tunings, you need to know your system and workload really well - so please verify any tunings with workloads matching your real use case.

## Support and troubleshooting

DPDK is a fast-evolving project. In any search for support and/or further guides, we highly recommended first checking to see if they apply to the current version.

You can check if your issues is known on:

- [DPDK Mailing Lists](#)
- For OpenVswitch-DPDK [OpenStack Mailing Lists](#)
- Known issues in [DPDK Launchpad Area](#)
- Join the IRC channels #DPDK or #openvswitch on freenode.

Issues are often due to missing small details in the general setup. Later on, these missing details cause problems which can be hard to track down to their root cause.

A common case seems to be the “could not open network device dpdk0 (No such device)” issue. This occurs rather late when setting up a port in Open vSwitch with DPDK, but the root cause (most of the time) is very early in the setup and initialisation. Here is an example of how proper initialiasation of a device looks - this can be found in the syslog/journal when starting Open vSwitch with DPDK enabled.

```

ovs-ctl[3560]: EAL: PCI device 0000:04:00.1 on NUMA socket 0
ovs-ctl[3560]: EAL: probe driver: 8086:1528 rte_ixgbe_pmd
ovs-ctl[3560]: EAL: PCI memory mapped at 0x7f2140000000
ovs-ctl[3560]: EAL: PCI memory mapped at 0x7f2140200000

```

If this is missing, either by ignored cards, failed initialisation or other reasons, later on there will be no DPDK device to refer to. Unfortunately, the logging is spread across syslog/journal and the openvswitch log. To enable some cross-checking, here is an example of what can be found in these logs, relative to the entered command.

**#Note:** This log was taken with dpdk 2.2 and openvswitch 2.5 but still looks quite similar (a bit extended) these days  
Captions:

```

CMD: that you enter
SYSLOG: (Including EAL and OVS Messages)
OVS-LOG: (Openvswitch messages)

```

### #PREPARATION

Bind an interface to DPDK UIO drivers, make Hugepages available, enable DPDK on OVS

```

CMD: sudo service openvswitch-switch restart

```

### SYSLOG:

```

2016-01-22T08:58:31.372Z|00003|daemon_unix(monitor)|INFO|pid 3329 died, killed (Terminated), exiting
2016-01-22T08:58:33.377Z|00002|vlog|INFO|opened log file /var/log/openvswitch/ovs-vsitchd.log
2016-01-22T08:58:33.381Z|00003|ovs_numa|INFO|Discovered 12 CPU cores on NUMA node 0

```

```
2016-01-22T08:58:33.381Z|00004|ovs_numa|INFO|Discovered 1 NUMA nodes and 12 CPU cores
2016-01-22T08:58:33.381Z|00005|reconnect|INFO|unix:/var/run/openvswitch/db.sock: connecting...
2016-01-22T08:58:33.383Z|00006|reconnect|INFO|unix:/var/run/openvswitch/db.sock: connected
2016-01-22T08:58:33.386Z|00007|bridge|INFO|ovs-vswitchd (Open vSwitch) 2.5.0
```

OVS-LOG:

```
systemd[1]: Stopping Open vSwitch...
systemd[1]: Stopped Open vSwitch.
systemd[1]: Stopping Open vSwitch Internal Unit...
ovs-ctl[3541]: * Killing ovs-vswitchd (3329)
ovs-ctl[3541]: * Killing ovssdb-server (3318)
systemd[1]: Stopped Open vSwitch Internal Unit.
systemd[1]: Starting Open vSwitch Internal Unit...
ovs-ctl[3560]: * Starting ovssdb-server
ovs-vsctl: ovs|00001|vsctl|INFO|Called as ovs-vsctl --no-wait -- init -- set Open_vSwitch . db-version=7.12.1
ovs-vsctl: ovs|00001|vsctl|INFO|Called as ovs-vsctl --no-wait set Open_vSwitch . ovs-version=2.5.0 "external-ids:system-id=\"e7c5ba80-bb14-45c1-b8eb-628f3ad03903\"" "system-type=\"Ubuntu\"" "system-version=\"16.04-xenial\""
ovs-ctl[3560]: * Configuring Open vSwitch system IDs
ovs-ctl[3560]: 2016-01-22T08:58:31Z|00001|dpdk|INFO|No -vhost_sock_dir provided - defaulting to /var/run/openvswitch
ovs-vswitchd: ovs|00001|dpdk|INFO|No -vhost_sock_dir provided - defaulting to /var/run/openvswitch
ovs-ctl[3560]: EAL: Detected lcore 0 as core 0 on socket 0
ovs-ctl[3560]: EAL: Detected lcore 1 as core 1 on socket 0
ovs-ctl[3560]: EAL: Detected lcore 2 as core 2 on socket 0
ovs-ctl[3560]: EAL: Detected lcore 3 as core 3 on socket 0
ovs-ctl[3560]: EAL: Detected lcore 4 as core 4 on socket 0
ovs-ctl[3560]: EAL: Detected lcore 5 as core 5 on socket 0
ovs-ctl[3560]: EAL: Detected lcore 6 as core 0 on socket 0
ovs-ctl[3560]: EAL: Detected lcore 7 as core 1 on socket 0
ovs-ctl[3560]: EAL: Detected lcore 8 as core 2 on socket 0
ovs-ctl[3560]: EAL: Detected lcore 9 as core 3 on socket 0
ovs-ctl[3560]: EAL: Detected lcore 10 as core 4 on socket 0
ovs-ctl[3560]: EAL: Detected lcore 11 as core 5 on socket 0
ovs-ctl[3560]: EAL: Support maximum 128 logical core(s) by configuration.
ovs-ctl[3560]: EAL: Detected 12 lcore(s)
ovs-ctl[3560]: EAL: VFIO modules not all loaded, skip VFIO support...
ovs-ctl[3560]: EAL: Setting up physically contiguous memory...
ovs-ctl[3560]: EAL: Ask a virtual area of 0x100000000 bytes
ovs-ctl[3560]: EAL: Virtual area found at 0x7f2040000000 (size = 0x100000000)
ovs-ctl[3560]: EAL: Requesting 4 pages of size 1024MB from socket 0
ovs-ctl[3560]: EAL: TSC frequency is ~2397202 KHz
ovs-vswitchd[3592]: EAL: TSC frequency is ~2397202 KHz
ovs-vswitchd[3592]: EAL: Master lcore 0 is ready (tid=fc6cbb00;cpuset=[0])
ovs-vswitchd[3592]: EAL: PCI device 0000:04:00.0 on NUMA socket 0
ovs-vswitchd[3592]: EAL: probe driver: 8086:1528 rte_ixgbe_pmd
ovs-vswitchd[3592]: EAL: Not managed by a supported kernel driver, skipped
ovs-vswitchd[3592]: EAL: PCI device 0000:04:00.1 on NUMA socket 0
ovs-vswitchd[3592]: EAL: probe driver: 8086:1528 rte_ixgbe_pmd
ovs-vswitchd[3592]: EAL: PCI memory mapped at 0x7f2140000000
ovs-vswitchd[3592]: EAL: PCI memory mapped at 0x7f2140200000
ovs-ctl[3560]: EAL: Master lcore 0 is ready (tid=fc6cbb00;cpuset=[0])
ovs-ctl[3560]: EAL: PCI device 0000:04:00.0 on NUMA socket 0
ovs-ctl[3560]: EAL: probe driver: 8086:1528 rte_ixgbe_pmd
ovs-ctl[3560]: EAL: Not managed by a supported kernel driver, skipped
ovs-ctl[3560]: EAL: PCI device 0000:04:00.1 on NUMA socket 0
ovs-ctl[3560]: EAL: probe driver: 8086:1528 rte_ixgbe_pmd
ovs-ctl[3560]: EAL: PCI memory mapped at 0x7f2140000000
ovs-ctl[3560]: EAL: PCI memory mapped at 0x7f2140200000
ovs-vswitchd[3592]: PMD: eth_ixgbe_dev_init(): MAC: 4, PHY: 3
ovs-vswitchd[3592]: PMD: eth_ixgbe_dev_init(): port 0 vendorID=0x8086 deviceID=0x1528
ovs-ctl[3560]: PMD: eth_ixgbe_dev_init(): MAC: 4, PHY: 3
ovs-ctl[3560]: PMD: eth_ixgbe_dev_init(): port 0 vendorID=0x8086 deviceID=0x1528
ovs-ctl[3560]: Zone 0: name:<RG_MP_log_history>, phys:0x83ffffec0, len:0x2080, virt:0x7f213ffffec0, socket_id:0, flags:0
```

```
ovs-ctl[3560]: Zone 1: name:<MP_log_history>, phys:0x83fd73d40, len:0x28a0c0, virt:0x7f213fd73d40, socket_id:0, flags:0
ovs-ctl[3560]: Zone 2: name:<rte_eth_dev_data>, phys:0x83fd43380, len:0x2f700, virt:0x7f213fd43380, socket_id:0, flags:0
ovs-ctl[3560]: * Starting ovs-vswitchd
ovs-ctl[3560]: * Enabling remote OVSDDB managers
systemd[1]: Started Open vSwitch Internal Unit.
systemd[1]: Starting Open vSwitch...
systemd[1]: Started Open vSwitch.
```

```
CMD: sudo ovs-vsctl add-br ovsdpdkbr0 -- set bridge ovsdpdkbr0 datapath_type=netdev
```

SYSLOG:

```
2016-01-22T08:58:56.344Z|00008|memory|INFO|37256 kB peak resident set size after 24.5 seconds
2016-01-22T08:58:56.346Z|00009|ofproto_dpif|INFO|netdev@ovs-netdev: Datapath supports recirculation
2016-01-22T08:58:56.346Z|00010|ofproto_dpif|INFO|netdev@ovs-netdev: MPLS label stack length probed as 3
2016-01-22T08:58:56.346Z|00011|ofproto_dpif|INFO|netdev@ovs-netdev: Datapath supports unique flow ids
2016-01-22T08:58:56.346Z|00012|ofproto_dpif|INFO|netdev@ovs-netdev: Datapath does not support ct_state
2016-01-22T08:58:56.346Z|00013|ofproto_dpif|INFO|netdev@ovs-netdev: Datapath does not support ct_zone
2016-01-22T08:58:56.346Z|00014|ofproto_dpif|INFO|netdev@ovs-netdev: Datapath does not support ct_mark
2016-01-22T08:58:56.346Z|00015|ofproto_dpif|INFO|netdev@ovs-netdev: Datapath does not support ct_label
2016-01-22T08:58:56.360Z|00016|bridge|INFO|bridge ovsdpdkbr0: added interface ovsdpdkbr0 on port 65534
2016-01-22T08:58:56.361Z|00017|bridge|INFO|bridge ovsdpdkbr0: using datapath ID 00005a4a1ed0a14d
2016-01-22T08:58:56.361Z|00018|connmgr|INFO|ovsdpdkbr0: added service controller "punix:/var/run/openvswitch/ovsdpdkbr0"
```

OVS-LOG:

```
ovs-vsctl: ovs|00001|vsctl|INFO|Called as ovs-vsctl add-br ovsdpdkbr0 -- set bridge ovsdpdkbr0 datapath_type=netdev
systemd-udevd[3607]: Could not generate persistent MAC address for ovs-netdev: No such file or directory
kernel: [50165.886554] device ovs-netdev entered promiscuous mode
kernel: [50165.901261] device ovsdpdkbr0 entered promiscuous mode
```

```
CMD: sudo ovs-vsctl add-port ovsdpdkbr0 dpdk0 -- set Interface dpdk0 type=dpdk
```

SYSLOG:

```
2016-01-22T08:59:06.369Z|00019|memory|INFO|peak resident set size grew 155% in last 10.0 seconds, from 37256 kB to 95008 kB
2016-01-22T08:59:06.369Z|00020|memory|INFO|handlers:4 ports:1 revalidators:2 rules:5
2016-01-22T08:59:30.989Z|00021|dpdk|INFO|Port 0: 8c:dc:d4:b3:6d:e9
2016-01-22T08:59:31.520Z|00022|dpdk|INFO|Port 0: 8c:dc:d4:b3:6d:e9
2016-01-22T08:59:31.521Z|00023|dpif_netdev|INFO|Created 1 pmd threads on numa node 0
2016-01-22T08:59:31.522Z|00001|dpif_netdev(pmd16)|INFO|Core 0 processing port 'dpdk0'
2016-01-22T08:59:31.522Z|00024|bridge|INFO|bridge ovsdpdkbr0: added interface dpdk0 on port 1
2016-01-22T08:59:31.522Z|00025|bridge|INFO|bridge ovsdpdkbr0: using datapath ID 00008cdcd4b36de9
2016-01-22T08:59:31.523Z|00002|dpif_netdev(pmd16)|INFO|Core 0 processing port 'dpdk0'
```

OVS-LOG:

```
ovs-vsctl: ovs|00001|vsctl|INFO|Called as ovs-vsctl add-port ovsdpdkbr0 dpdk0 -- set Interface dpdk0 type=dpdk
ovs-vswitchd[3595]: PMD: ixgbe_dev_tx_queue_setup(): sw_ring=0x7f211a79ebc0 hw_ring=0x7f211a7a6c00 dma_addr=0x81a7a6c00
ovs-vswitchd[3595]: PMD: ixgbe_set_tx_function(): Using simple tx code path
ovs-vswitchd[3595]: PMD: ixgbe_set_tx_function(): Vector tx enabled.
ovs-vswitchd[3595]: PMD: ixgbe_dev_rx_queue_setup(): sw_ring=0x7f211a78a6c0 sw_sc_ring=0x7f211a786580 hw_ring=0x7f211a786580
ovs-vswitchd[3595]: PMD: ixgbe_set_rx_function(): Vector rx enabled, please make sure RX burst size no less than 4 (port=0)
ovs-vswitchd[3595]: PMD: ixgbe_dev_tx_queue_setup(): sw_ring=0x7f211a79ebc0 hw_ring=0x7f211a7a6c00 dma_addr=0x81a7a6c00
...
```

```
CMD: sudo ovs-vsctl add-port ovsdpdkbr0 vhost-user-1 -- set Interface vhost-user-1 type=dpdkvhostuser
```

OVS-LOG:

```
2016-01-22T09:00:35.145Z|00026|dpdk|INFO|Socket /var/run/openvswitch/vhost-user-1 created for vhost-user port vhost-user-1
2016-01-22T09:00:35.145Z|00003|dpif_netdev(pmd16)|INFO|Core 0 processing port 'dpdk0'
2016-01-22T09:00:35.145Z|00004|dpif_netdev(pmd16)|INFO|Core 0 processing port 'vhost-user-1'
2016-01-22T09:00:35.145Z|00027|bridge|INFO|bridge ovsdpdkbr0: added interface vhost-user-1 on port 2
```

SYSLOG:

```
ovs-vsctl: ovs|00001|vsctl|INFO|Called as ovs-vsctl add-port ovsdpdkbr0 vhost-user-1 -- set Interface vhost-user-1 type=dpdkvhostuser
ovs-vswitchd[3595]: VHOST_CONFIG: socket created, fd:46
ovs-vswitchd[3595]: VHOST_CONFIG: bind to /var/run/openvswitch/vhost-user-1
```

Eventually we can see the poll thread in top

PID	USER	PR	NI	VIRT	RES	SHR	S	%CPU	%MEM	TIME+	COMMAND
3595	root	10	-10	4975344	103936	9916	S	100.0	0.3	33:13.56	ovs-vswitchd

## Resources

- [DPDK documentation](#)
- [Release Notes matching the version packages in Ubuntu 16.04](#)
- [Linux DPDK user getting started](#)
- [EAL command-line options](#)
- [DPDK API documentation](#)
- [Open Vswitch DPDK installation](#)
- [Wikipedia's definition of DPDK](#)

The cryptographic library landscape is vast and complex, and there are many crypto libraries available on an Ubuntu system. What an application developer decides to use can be governed by many aspects, such as:

- Technical requirements
- Language bindings
- License
- Community
- Ease of use
- General availability
- Upstream maintenance

Among the most popular and widely used libraries and frameworks, we have:

- OpenSSL
- GnuTLS
- NSS
- GnuPG
- gcrypt

Each one of these has its own implementation details, API, behavior, configuration file, and syntax.

This poses a challenge to system administrators who need to make sure what cryptographic algorithms are being used on the systems they deploy. How to ensure no legacy crypto is being used? Or that no keys below a certain size are ever selected or created? And which types of X509 certificates are acceptable for connecting to remote servers?

One has to check all of the crypto implementations installed on the system and their configuration. To make things even more complicated, sometimes an application implements its own crypto, without using anything external.

## How do we know which library an application is using?

Ultimately, the only reliable way to determine how an application uses cryptography is via its documentation or inspection of source code. But the code is not always available, and sometimes the documentation lacks this information. When the documentation isn't clear or enough, there are some other practical checks that can be made.

First, let's take a look at how an application could use crypto:

- **dynamic linking:** This is the most common way, and very easy to spot via package dependencies and helper tools. This is discussed later in this page.
- **static linking:** This is harder, as there is no dependency information in the binary package, and this usually requires inspection of the source package to see Build Dependencies. An example is shown later in this page.
- **plugins:** The main binary of an application can not depend directly on a crypto library, but it could load dynamic plugins which do. Usually these would be packaged separately, and then we fall under the dynamic

or static linking cases above. Note that via such a plugin mechanism, an application could depend on multiple external cryptographic libraries.

- **execution of external binary:** The application could just plain call external binaries at runtime for its cryptographic operations, like calling out to `openssl` or `gnupg` to encrypt/decrypt data. This will hopefully be expressed in the dependencies of the package. If it's not, then it's a bug that should be reported.
- **indirect usage:** The application could be using a third party library or executable which in turn could fall into any of the above categories.

## Identify the crypto libraries used by an application

Here are some tips that can help identifying the crypto libraries used by an application that is installed on an Ubuntu system:

### Documentation

Read the application documentation. It might have crypto options directly in its own configuration files, or point at specific crypto configuration files installed on the system. This may also clarify if the application even uses external crypto libraries, or if it has its own implementation.

### Package dependencies

The package dependencies are a good way to check what is needed at runtime by the application.

To find out the package that owns a file, use `dpkg -S`. For example:

```
$ dpkg -S /usr/bin/lynx
lynx: /usr/bin/lynx
```

Then, with the package name in hand, check its dependencies. It's best to also look for `Recommends`, as they are installed by default. Continuing with the example from before, we have:

```
$ dpkg -s lynx | grep -E "(Depends|Recommends)"
Depends: libbsd0 (>= 0.0), libbz2-1.0, libc6 (>= 2.34), libgnutls30 (>= 3.7.0), libidn2-0 (>= 2.0.0), libncursesw6 (>= 6),
common
Recommends: mime-support
```

Here we see that `lynx` links with `libgnutls30`, which answers our question: `lynx` uses the GnuTLS library for its cryptography operations.

### Dynamic linking, plugins

The dynamic libraries that are needed by an application should always be correctly identified in the list of dependencies of the application package. When that is not the case, or if you need to identify what is needed by some plugin that is not part of the package, you can use some system tools to help identify the dependencies.

A very helpful tool that is installed in all Ubuntu systems is `ldd`. It will list all the dynamic libraries that are needed by the given binary, including dependencies of dependencies, i.e., it's recursive. Going back to the `lynx` example:

```
$ ldd /usr/bin/lynx
linux-vdso.so.1 (0x00007ffffd2df000)
libz.so.1 => /lib/x86_64-linux-gnu/libz.so.1 (0x00007feb69d77000)
libbz2.so.1.0 => /lib/x86_64-linux-gnu/libbz2.so.1.0 (0x00007feb69d64000)
libidn2.so.0 => /lib/x86_64-linux-gnu/libidn2.so.0 (0x00007feb69d43000)
libncursesw.so.6 => /lib/x86_64-linux-gnu/libncursesw.so.6 (0x00007feb69d07000)
libtinfo.so.6 => /lib/x86_64-linux-gnu/libtinfo.so.6 (0x00007feb69cd5000)
libgnutls.so.30 => /lib/x86_64-linux-gnu/libgnutls.so.30 (0x00007feb69aea000)
libbsd.so.0 => /lib/x86_64-linux-gnu/libbsd.so.0 (0x00007feb69ad0000)
libc.so.6 => /lib/x86_64-linux-gnu/libc.so.6 (0x00007feb698a8000)
libunistring.so.2 => /lib/x86_64-linux-gnu/libunistring.so.2 (0x00007feb696fe000)
libp11-kit.so.0 => /lib/x86_64-linux-gnu/libp11-kit.so.0 (0x00007feb695c3000)
libtasn1.so.6 => /lib/x86_64-linux-gnu/libtasn1.so.6 (0x00007feb695ab000)
libnettle.so.8 => /lib/x86_64-linux-gnu/libnettle.so.8 (0x00007feb69565000)
libhogweed.so.6 => /lib/x86_64-linux-gnu/libhogweed.so.6 (0x00007feb6951b000)
libgmp.so.10 => /lib/x86_64-linux-gnu/libgmp.so.10 (0x00007feb69499000)
/lib64/ld-linux-x86-64.so.2 (0x00007feb69fe6000)
libmd.so.0 => /lib/x86_64-linux-gnu/libmd.so.0 (0x00007feb6948c000)
libffi.so.8 => /lib/x86_64-linux-gnu/libffi.so.8 (0x00007feb6947f000)
```



We again see the GnuTLS library (via `libgnutls.so.30`) in the list, and can reach the same conclusion.

Another way to check for such dependencies, but without the recursion, is via `objdump`. This may need to be installed via the `binutils` package, as it's not mandatory.

The way to use it is to grep for the `NEEDED` string:

```
$ objdump -x /usr/bin/lynx|grep NEEDED
NEEDED libz.so.1
NEEDED libbz2.so.1.0
NEEDED libidn2.so.0
NEEDED libncursesw.so.6
NEEDED libtinfo.so.6
NEEDED libgnutls.so.30
NEEDED libbsd.so.0
NEEDED libc.so.6
```

Finally, if you want to see the dependency *tree*, you can use `lddtree` from the `pax-utils` package:

```
$ lddtree /usr/bin/lynx
lynx => /usr/bin/lynx (interpreter => /lib64/ld-linux-x86-64.so.2)
 libz.so.1 => /lib/x86_64-linux-gnu/libz.so.1
 libbz2.so.1.0 => /lib/x86_64-linux-gnu/libbz2.so.1.0
 libidn2.so.0 => /lib/x86_64-linux-gnu/libidn2.so.0
 libunistring.so.2 => /lib/x86_64-linux-gnu/libunistring.so.2
 libncursesw.so.6 => /lib/x86_64-linux-gnu/libncursesw.so.6
 libtinfo.so.6 => /lib/x86_64-linux-gnu/libtinfo.so.6
 libgnutls.so.30 => /lib/x86_64-linux-gnu/libgnutls.so.30
 libp11-kit.so.0 => /lib/x86_64-linux-gnu/libp11-kit.so.0
 libffi.so.8 => /lib/x86_64-linux-gnu/libffi.so.8
 libtasn1.so.6 => /lib/x86_64-linux-gnu/libtasn1.so.6
 libnettle.so.8 => /lib/x86_64-linux-gnu/libnettle.so.8
 libhogweed.so.6 => /lib/x86_64-linux-gnu/libhogweed.so.6
 libgmp.so.10 => /lib/x86_64-linux-gnu/libgmp.so.10
 ld-linux-x86-64.so.2 => /lib64/ld-linux-x86-64.so.2
 libbsd.so.0 => /lib/x86_64-linux-gnu/libbsd.so.0
 libmd.so.0 => /lib/x86_64-linux-gnu/libmd.so.0
 libc.so.6 => /lib/x86_64-linux-gnu/libc.so.6
```

## Static linking

Identifying which libraries were used in a static build is a bit more involved. There are two ways, and they are complementary most of the time:

- look for the `Built-Using` header in the binary package
- inspect the `Build-Depends` header in the source package

For example, let's try to discover which crypto libraries, if any, the `rclone` tool uses. First, let's try the packaging dependencies:

```
$ dpkg -s rclone | grep -E "^(Depends|Recommends)"
Depends: libc6 (>= 2.34)
```

Uh, that's a short list. But `rclone` definitely supports encryption, so what is going on? Turns out this is a tool written in the Go language, and that uses static linking of libraries. So let's try to inspect the package data more carefully, and this time look for the `Built-Using` header:

```
$ dpkg -s rclone | grep Built-Using
```

```
Built-Using: go-md2man-v2 (= 2.0.1+ds1-1), golang-1.18 (= 1.18-1ubuntu1), golang-bazil-fuse (= 0.0~git20160811.0.371fbbd-3), ...
```

Ok, this time we have a lot of information (truncated above for brevity, since it's all in one very long line). If we look at the full output carefully, we can see that `rclone` was built statically using the `golang-go.crypto` package, and documentation about that package and its crypto implementations is what we should look for.

If the `Built-Using` header was not there, or didn't yield any clues, we could try one more step and look for the build dependencies. These can be found in the `debian/control` file of the source package. In the case of `rclone` for Ubuntu Jammy, that can be seen at <https://git.launchpad.net/ubuntu/+source/rclone/tree/debian/control?h=>

[ubuntu/jammy-devel#n7](#), and a quick look at the `Build-Depends` list shows us the `golang-golang-x-crypto-dev` build dependency, whose source package is `golang-go.crypto` as expected:

```
$ apt-cache show golang-golang-x-crypto-dev | grep ^Source:
Source: golang-go.crypto
```

#### NOTE

If there is no `Source:` line, then it means the name of the source package is the same as the binary package that was queried.

## What's next?

Now that you have uncovered which library your application is using, the following guides will help you to understand the associated configuration files and what options you have available (including some handy examples!).

- [OpenSSL guide](#)
- [GnuTLS guide](#)
- [Troubleshooting TLS/SSL](#)

OpenSSL is probably the most well known cryptographic library, used by thousands of projects and applications.

The OpenSSL configuration file is located at `/etc/ssl/openssl.cnf` and is used both by the library itself and the command-line tools included in the package. It is simple in structure, but quite complex in the details, and it won't be fully covered here. In particular, we will only cover the settings that control which cryptographic algorithms will be allowed by default.

## Structure of the config file

The OpenSSL configuration file is very similar to a standard INI file. It starts with a nameless default section, not inside any `[section]` block, and after that we have the traditional `[section-name]` followed by the `key = value` lines. The [ssl config manpage](#) has all the details.

This is what it looks like:

```
openssl_conf = <name-of-conf-section>
```

```
[name-of-conf-section]
ssl_conf = <name-of-ssl-section>
```

```
[name-of-ssl-section]
server = <name of section>
client = <name of section>
system_default = <name of section>
```

See how it's like a chain, where a key (`openssl_conf`) points at the name of a section, and that section has a key that points to another section, and so on.

To adjust the algorithms and ciphers used in a SSL/TLS connection, we are interested in the "SSL Configuration" section of the library, where we can define the behavior of server, client, and the library defaults.

For example, in an Ubuntu Jammy installation, we have (omitting unrelated entries for brevity):

```
openssl_conf = openssl_init
```

```
[openssl_init]
ssl_conf = ssl_sect
```

```
[ssl_sect]
system_default = system_default_sect
```

```
[system_default_sect]
CipherString = DEFAULT:@SECLEVEL=2
```

This gives us our first information about the default set of ciphers and algorithms used by OpenSSL in an Ubuntu installation: `DEFAULT:@SECLEVEL=2`. What that means is detailed inside the [SSL\\_CTX\\_set\\_security\\_level\(3\)](#) manpage.

#### NOTE

In Ubuntu Jammy, TLS versions below 1.2 are **disabled** in OpenSSL's `SECLEVEL=2` due to [this patch](#).

That default is also set at package building time, and in the case of Ubuntu, it's set to `SECLEVEL=2`.

The list of allowed ciphers in a security level can be obtained with the `openssl ciphers` command (output truncated for brevity):

```
$ openssl ciphers -s -v DEFAULT:@SECLEVEL=2
TLS_AES_256_GCM_SHA384 TLSv1.3 Kx=any Au=any Enc=AESGCM(256) Mac=AEAD
TLS_CHACHA20_POLY1305_SHA256 TLSv1.3 Kx=any Au=any Enc=CHACHA20/POLY1305(256) Mac=AEAD
TLS_AES_128_GCM_SHA256 TLSv1.3 Kx=any Au=any Enc=AESGCM(128) Mac=AEAD
ECDHE-ECDSA-AES256-GCM-SHA384 TLSv1.2 Kx=ECDH Au=ECDSA Enc=AESGCM(256) Mac=AEAD
(...)
```

#### NOTE

The `openssl ciphers` command will output even ciphers that are not allowed, unless the `-s` switch is given. That option tells the command to list only *supported* ciphers.

All the options that can be set in the `system_default_sect` section are detailed in the [SSL\\_CONF\\_cmd manpage](#).

## Cipher strings, cipher suites, cipher lists

Encrypting data (or signing it) is not a one step process. The whole transformation applied to the source data until it is in its encrypted form has several stages, and each stage typically uses a different cryptographic algorithm. The combination of these algorithms is called a cipher suite.

Similar to GnuTLS, OpenSSL also uses the concept of cipher strings to group several algorithms and cipher suites together. The full list of cipher strings is shown in the [openssl ciphers](#) manpage.

OpenSSL distinguishes the ciphers used with TLSv1.3, and those used with TLSv1.2 and older. Specifically for the `openssl ciphers` command, we have:

- `-ciphersuites`: used for the TLSv1.3 ciphersuites. There are so far just five listed in the [upstream documentation](#), and the defaults are:

```
TLS_AES_256_GCM_SHA384:TLS_CHACHA20_POLY1305_SHA256:TLS_AES_128_GCM_SHA256
```

- `cipherlist`: this is a plain argument in the command line of the `openssl ciphers` command, without a specific parameter, and is expected to be a list of cipher strings used in TLSv1.2 and lower. The default in Ubuntu Jammy 22.04 LTS is `DEFAULT:@SECLEVEL=2`.

These defaults are built-in in the library, and can be set in `/etc/ssl/openssl.cnf` via the corresponding configuration keys `CipherString` for TLSv1.2 and older, and `CipherSuites` for TLSv1.3. For example:

```
[system_default_sect]
CipherString = DEFAULT:@SECLEVEL=2
CipherSuites = TLS_AES_256_GCM_SHA384:TLS_CHACHA20_POLY1305_SHA256
```

In the end, without other constraints, the library will merge both lists into one set of supported crypto algorithms. If the crypto negotiation in a connection settles on TLSv1.3, then the list of *CipherSuites* is considered. If it's TLSv1.2 or lower, then *CipherString* is used.

### openssl ciphers examples

This will list all supported/enabled ciphers, with defaults taken from the library and `/etc/ssl/openssl.cnf`. Since no other options were given, this will include TLSv1.3 ciphersuites and TLSv1.2 and older cipher strings:

```
$ openssl ciphers -s -v
TLS_AES_256_GCM_SHA384 TLSv1.3 Kx=any Au=any Enc=AESGCM(256) Mac=AEAD
TLS_CHACHA20_POLY1305_SHA256 TLSv1.3 Kx=any Au=any Enc=CHACHA20/POLY1305(256) Mac=AEAD
TLS_AES_128_GCM_SHA256 TLSv1.3 Kx=any Au=any Enc=AESGCM(128) Mac=AEAD
ECDHE-ECDSA-AES256-GCM-SHA384 TLSv1.2 Kx=ECDH Au=ECDSA Enc=AESGCM(256) Mac=AEAD
ECDHE-RSA-AES256-GCM-SHA384 TLSv1.2 Kx=ECDH Au=RSA Enc=AESGCM(256) Mac=AEAD
DHE-RSA-AES256-GCM-SHA384 TLSv1.2 Kx=DH Au=RSA Enc=AESGCM(256) Mac=AEAD
ECDHE-ECDSA-CHACHA20-POLY1305 TLSv1.2 Kx=ECDH Au=ECDSA Enc=CHACHA20/POLY1305(256) Mac=AEAD
ECDHE-RSA-CHACHA20-POLY1305 TLSv1.2 Kx=ECDH Au=RSA Enc=CHACHA20/POLY1305(256) Mac=AEAD
DHE-RSA-CHACHA20-POLY1305 TLSv1.2 Kx=DH Au=RSA Enc=CHACHA20/POLY1305(256) Mac=AEAD
ECDHE-ECDSA-AES128-GCM-SHA256 TLSv1.2 Kx=ECDH Au=ECDSA Enc=AESGCM(128) Mac=AEAD
ECDHE-RSA-AES128-GCM-SHA256 TLSv1.2 Kx=ECDH Au=RSA Enc=AESGCM(128) Mac=AEAD
DHE-RSA-AES128-GCM-SHA256 TLSv1.2 Kx=DH Au=RSA Enc=AESGCM(128) Mac=AEAD
ECDHE-ECDSA-AES256-SHA384 TLSv1.2 Kx=ECDH Au=ECDSA Enc=AES(256) Mac=SHA384
ECDHE-RSA-AES256-SHA384 TLSv1.2 Kx=ECDH Au=RSA Enc=AES(256) Mac=SHA384
```

DHE-RSA-AES256-SHA256	TLSv1.2	Kx=DH	Au=RSA	Enc=AES(256)	Mac=SHA256
ECDHE-ECDSA-AES128-SHA256	TLSv1.2	Kx=ECDH	Au=ECDSA	Enc=AES(128)	Mac=SHA256
ECDHE-RSA-AES128-SHA256	TLSv1.2	Kx=ECDH	Au=RSA	Enc=AES(128)	Mac=SHA256
DHE-RSA-AES128-SHA256	TLSv1.2	Kx=DH	Au=RSA	Enc=AES(128)	Mac=SHA256
ECDHE-ECDSA-AES256-SHA	TLSv1	Kx=ECDH	Au=ECDSA	Enc=AES(256)	Mac=SHA1
ECDHE-RSA-AES256-SHA	TLSv1	Kx=ECDH	Au=RSA	Enc=AES(256)	Mac=SHA1
DHE-RSA-AES256-SHA	SSLv3	Kx=DH	Au=RSA	Enc=AES(256)	Mac=SHA1
ECDHE-ECDSA-AES128-SHA	TLSv1	Kx=ECDH	Au=ECDSA	Enc=AES(128)	Mac=SHA1
ECDHE-RSA-AES128-SHA	TLSv1	Kx=ECDH	Au=RSA	Enc=AES(128)	Mac=SHA1
DHE-RSA-AES128-SHA	SSLv3	Kx=DH	Au=RSA	Enc=AES(128)	Mac=SHA1
AES256-GCM-SHA384	TLSv1.2	Kx=RSA	Au=RSA	Enc=AESGCM(256)	Mac=AEAD
AES128-GCM-SHA256	TLSv1.2	Kx=RSA	Au=RSA	Enc=AESGCM(128)	Mac=AEAD
AES256-SHA256	TLSv1.2	Kx=RSA	Au=RSA	Enc=AES(256)	Mac=SHA256
AES128-SHA256	TLSv1.2	Kx=RSA	Au=RSA	Enc=AES(128)	Mac=SHA256
AES256-SHA	SSLv3	Kx=RSA	Au=RSA	Enc=AES(256)	Mac=SHA1
AES128-SHA	SSLv3	Kx=RSA	Au=RSA	Enc=AES(128)	Mac=SHA1

Let's filter this a bit, and just as an example, remove all AES128 ciphers and SHA1 hashes:

```
$ openssl ciphers -s -v 'DEFAULTS:-AES128:-SHA1'
```

TLS_AES_256_GCM_SHA384	TLSv1.3	Kx=any	Au=any	Enc=AESGCM(256)	Mac=AEAD
TLS_CHACHA20_POLY1305_SHA256	TLSv1.3	Kx=any	Au=any	Enc=CHACHA20/POLY1305(256)	Mac=AEAD
TLS_AES_128_GCM_SHA256	TLSv1.3	Kx=any	Au=any	Enc=AESGCM(128)	Mac=AEAD
ECDHE-ECDSA-AES256-GCM-SHA384	TLSv1.2	Kx=ECDH	Au=ECDSA	Enc=AESGCM(256)	Mac=AEAD
ECDHE-RSA-AES256-GCM-SHA384	TLSv1.2	Kx=ECDH	Au=RSA	Enc=AESGCM(256)	Mac=AEAD
DHE-RSA-AES256-GCM-SHA384	TLSv1.2	Kx=DH	Au=RSA	Enc=AESGCM(256)	Mac=AEAD
ECDHE-ECDSA-CHACHA20-POLY1305	TLSv1.2	Kx=ECDH	Au=ECDSA	Enc=CHACHA20/POLY1305(256)	Mac=AEAD
ECDHE-RSA-CHACHA20-POLY1305	TLSv1.2	Kx=ECDH	Au=RSA	Enc=CHACHA20/POLY1305(256)	Mac=AEAD
DHE-RSA-CHACHA20-POLY1305	TLSv1.2	Kx=DH	Au=RSA	Enc=CHACHA20/POLY1305(256)	Mac=AEAD
ECDHE-ECDSA-AES256-SHA384	TLSv1.2	Kx=ECDH	Au=ECDSA	Enc=AES(256)	Mac=SHA384
ECDHE-RSA-AES256-SHA384	TLSv1.2	Kx=ECDH	Au=RSA	Enc=AES(256)	Mac=SHA384
DHE-RSA-AES256-SHA256	TLSv1.2	Kx=DH	Au=RSA	Enc=AES(256)	Mac=SHA256
AES256-GCM-SHA384	TLSv1.2	Kx=RSA	Au=RSA	Enc=AESGCM(256)	Mac=AEAD
AES256-SHA256	TLSv1.2	Kx=RSA	Au=RSA	Enc=AES(256)	Mac=SHA256

Since we didn't use `-ciphersuites`, the TLSv1.3 list was unaffected by our filtering, and still contains the *AES128* cipher. But TLSv1.2 and older no longer have *AES128* or *SHA1*. This type of filtering with '+', '-' and '!' can be done with the TLSv1.2 and older protocols and is detailed in the [openssl ciphers manpage](#).

To filter out TLSv1.3 algorithms, there is no such mechanism, and we must just list explicitly what we want by using `-ciphersuites`:

```
$ openssl ciphers -s -v -ciphersuites TLS_AES_256_GCM_SHA384:TLS_CHACHA20_POLY1305_SHA256 'DEFAULTS:-AES128:-SHA1'
```

TLS_AES_256_GCM_SHA384	TLSv1.3	Kx=any	Au=any	Enc=AESGCM(256)	Mac=AEAD
TLS_CHACHA20_POLY1305_SHA256	TLSv1.3	Kx=any	Au=any	Enc=CHACHA20/POLY1305(256)	Mac=AEAD
ECDHE-ECDSA-AES256-GCM-SHA384	TLSv1.2	Kx=ECDH	Au=ECDSA	Enc=AESGCM(256)	Mac=AEAD
ECDHE-RSA-AES256-GCM-SHA384	TLSv1.2	Kx=ECDH	Au=RSA	Enc=AESGCM(256)	Mac=AEAD
DHE-RSA-AES256-GCM-SHA384	TLSv1.2	Kx=DH	Au=RSA	Enc=AESGCM(256)	Mac=AEAD
ECDHE-ECDSA-CHACHA20-POLY1305	TLSv1.2	Kx=ECDH	Au=ECDSA	Enc=CHACHA20/POLY1305(256)	Mac=AEAD
ECDHE-RSA-CHACHA20-POLY1305	TLSv1.2	Kx=ECDH	Au=RSA	Enc=CHACHA20/POLY1305(256)	Mac=AEAD
DHE-RSA-CHACHA20-POLY1305	TLSv1.2	Kx=DH	Au=RSA	Enc=CHACHA20/POLY1305(256)	Mac=AEAD
ECDHE-ECDSA-AES256-SHA384	TLSv1.2	Kx=ECDH	Au=ECDSA	Enc=AES(256)	Mac=SHA384
ECDHE-RSA-AES256-SHA384	TLSv1.2	Kx=ECDH	Au=RSA	Enc=AES(256)	Mac=SHA384
DHE-RSA-AES256-SHA256	TLSv1.2	Kx=DH	Au=RSA	Enc=AES(256)	Mac=SHA256
AES256-GCM-SHA384	TLSv1.2	Kx=RSA	Au=RSA	Enc=AESGCM(256)	Mac=AEAD
AES256-SHA256	TLSv1.2	Kx=RSA	Au=RSA	Enc=AES(256)	Mac=SHA256

## Config file examples

Let's see some practical examples of how we can use the configuration file to tweak the default cryptographic settings of an application linked with OpenSSL.

Note that applications can still override these settings: what is set in the configuration file merely acts as a default that is used when nothing else in the application command line or its own config says otherwise.

## Only use TLSv1.3

To configure the OpenSSL library to consider TLSv1.3 as the minimum acceptable protocol, we add a `MinProtocol` parameter to the `/etc/ssl/openssl.cnf` configuration file like this:

```
[system_default_sect]
CipherString = DEFAULT:@SECLEVEL=2
MinProtocol = TLSv1.3
```

If you then try to connect securely to a server that only offers, say TLSv1.2, the connection will fail:

```
$ curl https://j-server.lxd/stats
curl: (35) error:0A00042E:SSL routines::tlsv1 alert protocol version
```

```
$ wget https://j-server.lxd/stats
--2023-01-06 13:41:50-- https://j-server.lxd/stats
Resolving j-server.lxd (j-server.lxd)... 10.0.100.87
Connecting to j-server.lxd (j-server.lxd)|10.0.100.87|:443... connected.
OpenSSL: error:0A00042E:SSL routines::tlsv1 alert protocol version
Unable to establish SSL connection.
```

## Use only AES256 with TLSv1.3

As an additional constraint, besides forcing TLSv1.3, let's only allow AES256. This would do it for OpenSSL applications that do not override this elsewhere:

```
[system_default_sect]
CipherString = DEFAULT:@SECLEVEL=2
CipherSuites = TLS_AES_256_GCM_SHA384
MinProtocol = TLSv1.3
```

Since we are already forcing TLSv1.3, there is no need to tweak the `CipherString` list, since that applies only to TLSv1.2 and older.

The OpenSSL `s_server` command is very handy to test this (see [the Troubleshooting section](#) for details on how to use it):

```
$ sudo openssl s_server -cert j-server.pem -key j-server.key -port 443 -www
```

### NOTE

Be sure to use another system for this server, or else it will be subject to the same `/etc/ssl/openssl.cnf` constraints you are testing on the client, and this can lead to very confusing results.

As expected, a client will end up selecting TLSv1.3 and the `TLS_AES_256_GCM_SHA384` cipher suite:

```
$ wget https://j-server.lxd/stats -0 /dev/stdout -q | grep Cipher -w
New, TLSv1.3, Cipher is TLS_AES_256_GCM_SHA384
Cipher : TLS_AES_256_GCM_SHA384
```

To be sure, we can tweak the server to only offer `TLS_CHACHA20_POLY1305_SHA256` for example:

```
$ sudo openssl s_server -cert j-server.pem -key j-server.key -port 443 -www -ciphersuites TLS_CHACHA20_POLY1305_SHA256
```

And now the client will fail:

```
$ wget https://j-server.lxd/stats -0 /dev/stdout
--2023-01-06 14:20:55-- https://j-server.lxd/stats
Resolving j-server.lxd (j-server.lxd)... 10.0.100.87
Connecting to j-server.lxd (j-server.lxd)|10.0.100.87|:443... connected.
OpenSSL: error:0A000410:SSL routines::sslv3 alert handshake failure
Unable to establish SSL connection.
```

## Drop AES128 entirely

If we want to still allow TLS v1.2, but just drop AES128, then we need to configure the ciphers separately for TLS v1.3 and v1.2 or lower:

```
[system_default_sect]
CipherString = DEFAULT:@SECLEVEL=2:!AES128
CipherSuites = TLS_AES_256_GCM_SHA384:TLS_CHACHA20_POLY1305_SHA256
MinProtocol = TLSv1.2
```

To test, let's force our test `s_server` server to only offer TLSv1.2:

```
$ sudo openssl s_server -cert j-server.pem -key j-server.key -port 443 -www -tls1_2
```

And our client picks AES256:

```
$ wget https://j-server.lxd/stats -O /dev/stdout -q | grep Cipher -w
New, TLSv1.2, Cipher is ECDHE-RSA-AES256-GCM-SHA384
Cipher : ECDHE-RSA-AES256-GCM-SHA384
```

But that could also be just because AES256 is stronger than AES128. Let's not offer AES256 on the server, and also jump ahead and also remove CHACHA20, which would be the next one preferable to AES128:

```
$ sudo openssl s_server -cert j-server.pem -key j-server.key -port 443 -www -tls1_2 -cipher 'DEFAULT:!AES256:!CHACHA20'
```

Surely `wget` should fail now. Well, turns out it does select AES128:

```
$ wget https://j-server.lxd/stats -O /dev/stdout -q | grep Cipher -w
New, TLSv1.2, Cipher is ECDHE-RSA-AES128-GCM-SHA256
Cipher : ECDHE-RSA-AES128-GCM-SHA256
```

It's unclear why. Maybe it's a safeguard, or maybe AES128 is always allowed in TLSv1.2 and we produced an invalid configuration. This case shows how crypto is complex, and also applications can override any such configuration setting that comes from the library. As a counter example, OpenSSL's `s_client` tool follows the library config, and fails in this case:

```
$ echo | openssl s_client -connect j-server.lxd:443 | grep -w -i cipher
4007F4F9D47F0000:error:0A000410:SSL routines:ssl3_read_bytes:sslv3 alert handshake failure:../ssl/record/rec_layer_s3.
New, (NONE), Cipher is (NONE)
```

But we can override that as well with a command-line option and force `s_client` to allow AES128:

```
$ echo | openssl s_client -connect j-server.lxd:443 --cipher DEFAULT:AES128 2>&1 | grep -w -i cipher
New, TLSv1.2, Cipher is ECDHE-RSA-AES128-GCM-SHA256
Cipher : ECDHE-RSA-AES128-GCM-SHA256
```

## References

- [OpenSSL home page](#)
- SECLEVEL description:
  - [https://www.openssl.org/docs/man3.0/man3/SSL\\_CTX\\_set\\_security\\_level.html](https://www.openssl.org/docs/man3.0/man3/SSL_CTX_set_security_level.html)
  - <https://www.feistyduck.com/library/openssl-cookbook/online/openssl-command-line/understanding-security-levels.html>
- Configuration directives that can be used in the `system_default_sect` section: [https://manpages.ubuntu.com/manpages/jammy/en/man3/SSL\\_CONF\\_cmd.3ssl.html#supported%20configuration%20file%20commands](https://manpages.ubuntu.com/manpages/jammy/en/man3/SSL_CONF_cmd.3ssl.html#supported%20configuration%20file%20commands)

When initialized, the GnuTLS library tries to read its system-wide configuration file `/etc/gnutls/config`. If the file doesn't exist, built-in defaults are used. To make configuration changes, the `/etc/gnutls` directory and the `config` file in it have to be created manually, as they are not shipped in the Ubuntu packaging.

This config file can be used to disable (or mark as insecure) algorithms and protocols in a system-wide manner, overriding the library defaults. Note that, intentionally, any algorithms or protocols that were disabled or marked as insecure cannot then be re-enabled or marked as secure.

There are many configuration options available for GnuTLs, and it's strongly recommended to carefully read the upstream documentation listed in the References section at the end of this page if creating this file or making changes to it.

## Structure of the config file

The GnuTLS configuration file is structured as an INI-style text file. There are three sections, and each section contains `key = values` lines. For example:

```
[global]
override-mode = blocklist
```

```
[priorities]
```

```
SYSTEM = NORMAL:-MD5
```

```
[overrides]
tls-disabled-mac = sha1
```

## The global section

The [global] section sets the override mode used in the [overrides] section:

- `override-mode = blacklist`: the algorithms listed in [overrides] are disabled
- `override-mode = allowlist`: the algorithms listed in [overrides] are enabled.

Note that in the `allowlist` mode, all algorithms that should be enabled must be listed in [overrides], as the library starts with marking all existing algorithms as disabled/insecure. In practice, this means that using `allowlist` tends to make the list in [overrides] quite large. Additionally, GnuTLS automatically constructs a `SYSTEM` keyword (that can be used in [priorities]) with all the allowed algorithms and ciphers specified in [overrides].

When using `allowlist`, then all options in [overrides] will be of the enabled form. For example:

```
[global]
override-mode = allowlist

[overrides]
secure-hash = sha256
enabled-curve = secp256r1
secure-sig = ecdsa-secp256r1-sha256
enabled-version = tls1.3
tls-enabled-cipher = aes-128-gcm
tls-enabled-mac = aead
tls-enabled-group = secp256r1
```

And when using `blacklist`, all [override] options have the opposite meaning (disable):

```
[global]
override-mode = blacklist

[overrides]
tls-disabled-cipher = aes-128-cbc
tls-disabled-cipher = aes-256-cbc
tls-disabled-mac = sha1
tls-disabled-group = group-ffdhe8192
```

For other examples and a complete list of the valid keys in the [overrides] section, please refer to [Disabling algorithms and protocols](#).

## Priority strings

The [priorities] section is used to construct *priority strings*. These strings are a way to specify the TLS session's handshake algorithms and options in a compact, easy-to-use, format. Note that priority strings are not guaranteed to imply the same set of algorithms and protocols between different GnuTLS versions.

The default priority string is selected at package build time by the vendor, and in the case of Ubuntu Jammy it's [defined in debian/rules](#) as:

```
NORMAL:-VERS-ALL:+VERS-TLS1.3:+VERS-TLS1.2:+VERS-DTLS1.2:%PROFILE_MEDIUM
```

A priority string can start with a single initial keyword, and then add or remove algorithms or special keywords. The `NORMAL` priority string is [defined in this table](#) in the upstream documentation reference, which also includes many other useful keywords that can be used.

To see the resulting list of ciphers and algorithms from a priority string, one can use the `gnutls-cli` command-line tool. For example, to list all the ciphers and algorithms allowed with the priority string `SECURE256`:

```
$ gnutls-cli --list --priority SECURE256
Cipher suites for SECURE256
TLS_AES_256_GCM_SHA384 0x13, 0x02 TLS1.3
TLS_CHACHA20_POLY1305_SHA256 0x13, 0x03 TLS1.3
TLS_ECDHE_ECDSA_AES_256_GCM_SHA384 0xc0, 0x2c TLS1.2
TLS_ECDHE_ECDSA_CHACHA20_POLY1305 0xcc, 0xa9 TLS1.2
```

TLS_ECDHE_ECDSA_AES_256_CCM	0xc0, 0xad	TLS1.2
TLS_ECDHE_RSA_AES_256_GCM_SHA384	0xc0, 0x30	TLS1.2
TLS_ECDHE_RSA_CHACHA20_POLY1305	0xcc, 0xa8	TLS1.2
TLS_RSA_AES_256_GCM_SHA384	0x00, 0x9d	TLS1.2
TLS_RSA_AES_256_CCM	0xc0, 0x9d	TLS1.2
TLS_DHE_RSA_AES_256_GCM_SHA384	0x00, 0x9f	TLS1.2
TLS_DHE_RSA_CHACHA20_POLY1305	0xcc, 0xaa	TLS1.2
TLS_DHE_RSA_AES_256_CCM	0xc0, 0x9f	TLS1.2

Protocols: VERS-TLS1.3, VERS-TLS1.2, VERS-TLS1.1, VERS-TLS1.0, VERS-DTLS1.2, VERS-DTLS1.0

Ciphers: AES-256-GCM, CHACHA20-POLY1305, AES-256-CBC, AES-256-CCM

MACs: AEAD

Key Exchange Algorithms: ECDHE-ECDSA, ECDHE-RSA, RSA, DHE-RSA

Groups: GROUP-SECP384R1, GROUP-SECP521R1, GROUP-FFDHE8192

PK-signatures: SIGN-RSA-SHA384, SIGN-RSA-PSS-SHA384, SIGN-RSA-PSS-RSAE-SHA384, SIGN-ECDSA-SHA384, SIGN-ECDSA-SECP384R1-SHA384, SIGN-EdDSA-Ed448, SIGN-RSA-SHA512, SIGN-RSA-PSS-SHA512, SIGN-RSA-PSS-RSAE-SHA512, SIGN-ECDSA-SHA512, SIGN-ECDSA-SECP521R1-SHA512

You can manipulate the resulting set by manipulating the priority string. For example, to remove CHACHA20-POLY1305 from the SECURE256 set:

```
$ gnutls-cli --list --priority SECURE256:-CHACHA20-POLY1305
Cipher suites for SECURE256:-CHACHA20-POLY1305
TLS_AES_256_GCM_SHA384 0x13, 0x02 TLS1.3
TLS_ECDHE_ECDSA_AES_256_GCM_SHA384 0xc0, 0x2c TLS1.2
TLS_ECDHE_ECDSA_AES_256_CCM 0xc0, 0xad TLS1.2
TLS_ECDHE_RSA_AES_256_GCM_SHA384 0xc0, 0x30 TLS1.2
TLS_RSA_AES_256_GCM_SHA384 0x00, 0x9d TLS1.2
TLS_RSA_AES_256_CCM 0xc0, 0x9d TLS1.2
TLS_DHE_RSA_AES_256_GCM_SHA384 0x00, 0x9f TLS1.2
TLS_DHE_RSA_AES_256_CCM 0xc0, 0x9f TLS1.2
```

Protocols: VERS-TLS1.3, VERS-TLS1.2, VERS-TLS1.1, VERS-TLS1.0, VERS-DTLS1.2, VERS-DTLS1.0

Ciphers: AES-256-GCM, AES-256-CBC, AES-256-CCM

MACs: AEAD

Key Exchange Algorithms: ECDHE-ECDSA, ECDHE-RSA, RSA, DHE-RSA

Groups: GROUP-SECP384R1, GROUP-SECP521R1, GROUP-FFDHE8192

PK-signatures: SIGN-RSA-SHA384, SIGN-RSA-PSS-SHA384, SIGN-RSA-PSS-RSAE-SHA384, SIGN-ECDSA-SHA384, SIGN-ECDSA-SECP384R1-SHA384, SIGN-EdDSA-Ed448, SIGN-RSA-SHA512, SIGN-RSA-PSS-SHA512, SIGN-RSA-PSS-RSAE-SHA512, SIGN-ECDSA-SHA512, SIGN-ECDSA-SECP521R1-SHA512

And you can give this a new name by adding the following to the [priorities] section:

```
[priorities]
MYSET = SECURE256:-CHACHA20-POLY1305
```

Which allows the MYSET priority string to be used like this:

```
$ gnutls-cli --list --priority @MYSET
```

## Verification profile (overrides)

When verifying a certificate, or TLS session parameters, GnuTLS uses a set of profiles associated with the session to determine whether the parameters seen in the session are acceptable. These profiles are normally set using the %PROFILE priority string, but it is also possible to set a low bar that applications cannot override. This is done with the min-verification-profile setting in the [overrides] section.

For example:

```
[overrides]
do not allow applications use the LOW or VERY-WEAK profiles.
min-verification-profile = legacy
```

The list of values that can be used, and their meaning, is show in the [Key sizes and security parameters](#) table in the upstream documentation.



## Practical examples

Let's see some practical examples of how we can use the configuration file to tweak the default cryptographic settings of an application linked with GnuTLS.

Contrary to OpenSSL, for example, GnuTLS does not allow a cipher that was once removed, to be allowed again. So if you have a setting in the GnuTLS config file that prohibits *CHACHA20*, an application using GnuTLS will not be able to allow it.

### Only use TLSv1.3

One way to do it is to set a new default priority string that removes all TLS versions and then adds back just TLS 1.3:

```
[global]
override-mode = blocklist

[overrides]
default-priority-string = NORMAL:-VERS-TLS-ALL:+VERS-TLS1.3
```

With our test server providing everything but TLSv1.3:

```
$ sudo openssl s_server -cert j-server.pem -key j-server.key -port 443 -no_tls1_3 -www
```

Connections will fail:

```
$ gnutls-cli j-server.lxd
Processed 125 CA certificate(s).
Resolving 'j-server.lxd:443'...
Connecting to '10.0.100.87:443'...
*** Fatal error: A TLS fatal alert has been received.
*** Received alert [70]: Error in protocol version
```

An application linked with GnuTLS will also fail:

```
$ lftp -c "cat https://j-server.lxd/status"
cat: /status: Fatal error: gnutls_handshake: A TLS fatal alert has been received.
```

But an application can override these settings, because it's just the priority string that is being manipulated in the GnuTLS config:

```
$ lftp -c "set ssl:priority NORMAL:+VERS-TLS-ALL; cat https://j-server.lxd/status" | grep ^New
New, TLSv1.2, Cipher is ECDHE-RSA-AES256-GCM-SHA384
```

Another way to limit the TLS versions is via specific protocol version configuration keys:

```
[global]
override-mode = blocklist

[overrides]
disabled-version = tls1.1
disabled-version = tls1.2
disabled-version = tls1.0
```

Note that setting the same key multiple times just appends the new value to the previous value(s).

In this scenario, the application cannot override the config anymore:

```
$ lftp -c "set ssl:priority NORMAL:+VERS-TLS-ALL; cat https://j-server.lxd/status" | grep ^New
cat: /status: Fatal error: gnutls_handshake: A TLS fatal alert has been received.
```

### Use only AES256 with TLSv1.3

TLSv1.3 has a small list of ciphers, but it includes AES128. Let's remove it:

```
[global]
override-mode = blocklist

[overrides]
disabled-version = tls1.1
disabled-version = tls1.2
disabled-version = tls1.0
```

```
tls-disabled-cipher = AES-128-GCM
```

If we now connect to a server that was brought up with this config:

```
$ sudo openssl s_server -cert j-server.pem -key j-server.key -port 443 -ciphersuites TLS_AES_128_GCM_SHA256 -www
```

Our GnuTLS client will fail:

```
$ gnutls-cli j-server.lxd
Processed 126 CA certificate(s).
Resolving 'j-server.lxd:443'...
Connecting to '10.0.100.87:443'...
*** Fatal error: A TLS fatal alert has been received.
*** Received alert [40]: Handshake failed
```

And given GnuTLS's behavior regarding re-enabling a cipher that was once removed, we cannot allow AES128 from the command line either:

```
$ gnutls-cli --priority="NORMAL:+AES-128-GCM" j-server.lxd
Processed 126 CA certificate(s).
Resolving 'j-server.lxd:443'...
Connecting to '10.0.100.87:443'...
*** Fatal error: A TLS fatal alert has been received.
*** Received alert [40]: Handshake failed
```

## References

- [System-wide configuration](#)
- [Priority strings](#)
- [min-verification-profile values](#)
- [Disabling algorithms and protocols](#)
- [Invoking the gnutls-cli command line tool](#)

Network Security Services, or NSS, is a set of libraries that was originally developed by Netscape and later inherited by Mozilla. In Ubuntu, it's used mainly in Mozilla products such as Firefox and Thunderbird, but there are modules and language bindings available for other packages to use.

Given its origins in the Netscape browser, this library used to be bundled together with the applications that required it. Up to this day, for example, the Debian package of Mozilla Thunderbird has its own copy of `libnss3`, ignoring the system-wide one shipped by the `libnss3` Debian package.

## Config file

NSS doesn't have a system-wide policy configuration file in Ubuntu (see [#2016303](#) for details). That leaves the remaining location for the configuration file to be in the NSS "database" directory. Depending on the application, it can be in the following places by default:

- `~/.pki/nssdb/pkcs11.txt`  
This is where the system-provided `libnss3` library will look by default.
- `~/snap/firefox/common/.mozilla/firefox/<random>.default/pkcs11.txt`  
This is where the Firefox snap will look.
- `~/.thunderbird/<random>.default-release/pkcs11.txt`  
Mozilla Thunderbird ships with its own copy of `libnss3`, and is configured to look into this directory to find it.
- `~/.netscape/pkcs11.txt`  
This is the default used by the NSS tools shipped in the `libnss3-tools` Debian package.

The directory where `pkcs11.txt` is looked up is also the NSS database directory. NSS will store the certificates and private keys it imports or generates here, and the directory will typically contain these SQLITE3 database files:

- `cert9.db`: certificates database
- `key4.db`: private key database

With the `pkcs11.txt` file we can load PKCS#11 modules, including the one built into NSS itself. Other examples of modules that can be loaded from there are modules for smart cards or other hardware-based cryptographic devices. Of interest to us here, though, is the policy module.

## Configuring the NSS policy module

The policy module is defined like this in `pkcs11.txt`:

```
library=
name=Policy
NSS=flags=policyOnly,moduleDB
config="disallow=<list> allow=<list> flags=<flags>"
```

It's via the `config=` line that we can list which cryptographic algorithms we want to allow and disallow. The terms in the list are separated with a colon (":") and consist of the following:

- **The special keyword "ALL"**, meaning all possible values and algorithms. It's mostly used with `disallow`, so that a clean slate can be constructed with a following `allow` list. For example, `disallow=ALL allow=<list of allowed>` would only allow the algorithms explicitly listed in the `allow` list.
- **Algorithm name**: Standard names like `sha256`, `hmac-sha256`, `chacha20-poly1305`, `aes128-gcm` and others.
- **Version specifiers**: A minimum or maximum version for a protocol. These are the available ones:
  - `tls-version-min`, `tls-version-max`: Minimum and maximum version for the TLS protocol. For example, `tls-version-min=tls1.2`.
  - `dtls-version-min`, `dtls-version-max`: As above, but for DTLS (TLS over UDP)
- **Key sizes**: Minimum size for a key:
  - `DH-MIN`: Diffie-Helman minimum key size. For example, `DH-MIN=2048` specifies a minimum of 2048 bits.
  - `DSA-MIN`: Digital Signature Algorithm minimum key size. For example, `DSA-MIN=2048` specifies a minimum of 2048 bits.
  - `RSA-MIN`: RSA minimum key size. For example, `RSA-MIN=2048` specifies a minimum of 2048 bits.
- **Signature qualifier**: Selects the specified algorithm with a specific type of signature. For example, `sha256/cert-signature`. Here are some of the qualifiers that are available:
  - `/cert-signature`: Used in certificate signatures, certificate revocation lists (CRLs) and Online Certificate Status Protocol (OCSP).
  - `/signature`: Used in any signature.
  - `/all`: Combines SSL, SSL key exchange, and signatures.
  - `/ssl-key-exchange`: Used in the SSL key exchange.
  - `/ssl`: Used in the SSL record protocol.

The `disallow` rules are always parsed first, and then the `allow` ones, independent of the order in which they appear.

There are extra flags that can be added to the `config` line as well, in a comma-separated list if more than one is specified:

- `policy-lock`: Turn off the ability for applications to change policy with API calls.
- `ssl-lock`: Turn off the ability to change the SSL defaults.

## Practical examples

Let's see some practical examples of how we can use the configuration file to tweak the default cryptographic settings of an application linked with the system NSS libraries.

For these examples, we will be using the configuration file located in `~/.pki/nssdb/pkcs11.txt`. As noted before, depending on the application this file can be in another directory.

The examples will use the `tstclnt` test application that is part of the `libnss3-tools` Debian package. For the server part, we will be using the OpenSSL test server on the same system. Since it uses the OpenSSL library, it won't be affected by the changes we make to the NSS configuration.

## Bootstrapping the NSS database

Install the `libnss3-tools` package which has the necessary tools we will need:

```
sudo apt install libnss3-tools
```

If you don't have a `~/pki/nssdb` directory yet, it will have to be created first. For that, we will use the `certutil` command, also part of the `libnss3-tools` package. This will bootstrap the NSS database in that directory, and also create the initial `pkcs11.txt` file we will tweak in the subsequent examples:

```
mkdir -p ~/pki/nssdb
certutil -d ~/pki/nssdb -N
```

If you already have a populated `~/pki/nssdb` directory, there is no need to run the above commands.

When running the `certutil` command as shown, you will be asked to choose a password. That password will protect the NSS database, and will be requested whenever certain changes are made to it.

In the following examples we will make changes to the `pkcs11.txt` file inside the NSS database directory. The bootstrap process above will have created this file for us already. The changes that we will make should be *added* to the file, and not replace it. For example, these are the contents of `~/pki/nssdb/pkcs11.txt` right after the bootstrap process:

```
library=
name=NSS Internal PKCS #11 Module
parameters=configdir='/home/ubuntu/.pki/nssdb' certPrefix='' keyPrefix='' secmod='secmod.db' flags= updatedir='' update
NSS=Flags=internal,critical trustOrder=75 cipherOrder=100 slotParams=(1={slotFlags=[ECC,RSA,DSA,DH,RC2,RC4,DES,RANDOM,
```

When an example asks to configure the policy module, its block should be appended to the existing configuration block in the file. For example:

```
library=
name=NSS Internal PKCS #11 Module
parameters=configdir='/home/ubuntu/.pki/nssdb' certPrefix='' keyPrefix='' secmod='secmod.db' flags= updatedir='' update
NSS=Flags=internal,critical trustOrder=75 cipherOrder=100 slotParams=(1={slotFlags=[ECC,RSA,DSA,DH,RC2,RC4,DES,RANDOM,
```

```
library=
name=Policy
NSS=flags=policyOnly,moduleDB
config="allow=tlsv1.3"
```

## Test setup

For these examples, we will be using a simple OpenSSL server on the same system as the NSS client we are testing. For that we will have to generate a certificate and key for the OpenSSL server to use, and then import that into the NSS database so it can be trusted.

First, generate a keypair for OpenSSL:

```
openssl req -new -x509 -days 30 -nodes -subj "/CN=localhost" -out localhost.pem -keyout localhost.key
```

To avoid telling `tstclnt` to ignore certification validation errors, which might mask the crypto policy changes we are trying to demonstrate, it's best to import this certificate into the NSS database and mark it as trusted:

```
certutil -d ~/pki/nssdb -A -a -i localhost.pem -t TCP -n localhost
```

This command will ask you for the NSS database password that you supplied when bootstrapping it. The command line options that were used have the following meanings:

- `-d ~/pki/nssdb`: The path to the NSS database.
- `-A`: Import a certificate.
- `-a`: The certificate is in ASCII mode (PEM).
- `-i localhost.pem`: The file to read (the actual certificate).
- `-t TCP`: Trust flags (see the `-t trustargs` argument in the [certutil manpage](#) for a full list).
  - `T`: Trusted CA for client authentication.
  - `C`: Trusted CA.
  - `P`: Trusted peer.
- `-n localhost`: A nickname for this certificate, like a label. It can be used later on to select this certificate.

We are now ready to begin our tests. *Unless otherwise noted*, this is how it's expected that the server will be run:

```
openssl s_server -accept 4443 -cert localhost.pem -key localhost.key -www
```

## The `tstclnt` tool

The `libnss3-tools` package also contains the `tstclnt` tool, which is what we will use in the following examples to test our NSS configuration changes.

This is the typical command we will use:

```
tstclnt -d ~/.pki/nssdb -h localhost -p 4443
```

Where the options have the following meanings:

- `-d ~/.pki/nssdb`: Use the NSS database located in the `~/.pki/nssdb` directory.
- `-h localhost`: The server to connect to.
- `-p 4443`: The TCP port to connect to.

To make things a bit easier to see, since this tool prints a lot of information about the connection, we will wrap it like this:

```
echo "GET / HTTP/1.0" | tstclnt -d ~/.pki/nssdb -h localhost -p 4443 2>&1 | grep ^New
```

```
New, TLSv1.3, Cipher is TLS_AES_128_GCM_SHA256
^C
```

The above tells us that the connection was completed and that it is using TLSv1.3, with a TLS\_AES\_128\_GCM\_SHA256 cipher suite.

It will not exit on its own, so it's necessary to press Ctrl+C (^C) to get back to the shell prompt.

### Only use TLSv1.3

Here is how we can restrict the TLS protocol version to 1.3 at a minimum:

```
library=
name=Policy
NSS=flags=policyOnly,moduleDB
config="allow=tls-version-min=tls1.3"
```

If we then start the OpenSSL server without TLSv1.3 support, like this (note the extra `no_tls1_3` at the end):

```
openssl s_server -accept 4443 -cert localhost.pem -key localhost.key -www -no_tls1_3
```

The `tstclnt` tool will fail to connect:

```
echo "GET / HTTP/1.0" | tstclnt -d ~/.pki/nssdb -h localhost -p 4443 2>&1 | grep ^New
echo $?
```

```
1
```

To see the actual error, we can remove the `grep` at the end:

```
echo "GET / HTTP/1.0" | tstclnt -d ~/.pki/nssdb -h localhost -p 4443 2>&1
```

```
tstclnt: write to SSL socket failed: SSL_ERROR_PROTOCOL_VERSION_ALERT: Peer reports incompatible or unsupported protocol
```

If we allow the server to offer TLSv1.3:

```
openssl s_server -accept 4443 -cert localhost.pem -key localhost.key -www
```

Then the connection completes:

```
echo "GET / HTTP/1.0" | tstclnt -d ~/.pki/nssdb -h localhost -p 4443 2>&1 | grep ^New
```

```
New, TLSv1.3, Cipher is TLS_AES_128_GCM_SHA256
^C
```

### Use only AES256 with TLSv1.3

In the previous example, the connection ended up using TLSv1.3 as expected, but AES128. To enforce AES256, we can disallow the 128-bit version:

```
library=
name=Policy
NSS=flags=policyOnly,moduleDB
config="disallow=aes128-gcm allow=tls-version-min=tls1.3"
```

This time the client selects something else:

```
echo "GET / HTTP/1.0" | tstclnt -d ~/.pki/nssdb -h localhost -p 4443 2>&1 | grep ^New
```

```
New, TLSv1.3, Cipher is TLS_CHACHA20_POLY1305_SHA256
```

We can remove that one from the list as well:

```
config="disallow=aes128-gcm:chacha20-poly1305 allow=tls-version-min=tls1.3"
```

And now we get AES256:

```
echo "GET / HTTP/1.0" | tstcInt -d ~/.pki/nssdb -h localhost -p 4443 2>&1 | grep ^New
```

```
New, TLSv1.3, Cipher is TLS_AES_256_GCM_SHA384
```

## References

Unfortunately most of the upstream Mozilla documentation is either outdated or deprecated, and the best reference available about the policy module at the moment is in the source code and tests.

- [In the source code](#)
- [In the tests \(policy\)](#)
- [In the tests \(SSL policy\)](#)

The Java cryptographic settings are large and complex, with many layers and policies. Here we will focus on one aspect of it, which is how to apply some basic filters to the set of cryptographic algorithms available to applications. The references section at the end contains links to more information.

There are many versions of Java available in Ubuntu. It's best to install the "default" one, which is represented by the `default-jre` (for the Runtime Environment) or `default-jdk` (for the Development Kit). And their non-GUI counterparts `default-jre-headless` and `default-jdk-headless`, respectively.

To install the default Java Runtime on Ubuntu Server, run the following command:

```
sudo apt install default-jre-headless
```

## Config file

The Java installation in Ubuntu ships a system-wide configuration tree under `/etc/java-<VERSION>-openjdk`. In Ubuntu Jammy 22.04 LTS, the default Java version is 11, so this directory will be `/etc/java-11/openjdk`. In that directory, the file that defines Java security settings, including cryptographic algorithms, is `/etc/java-11-openjdk/security/java.security`.

This is a very large file, with many options and comments. Its structure is simple, with configuration keys and their values. For crypto algorithms, we will be looking into the following settings:

- `jdk.certpath.disabledAlgorithms`: Restrictions on algorithms and key lengths used in certificate path processing.
- `jdk.tls.disabledAlgorithms`: Restrictions on algorithms and key lengths used in SSL/TLS connections.

The list of restrictions has its own format which allows for constructs that disable whole families of algorithms, key sizes, usage, and more. The [java.security configuration file](#) has comments explaining this syntax with some examples.

Changes to these security settings can be made directly in the `/etc/java-11-openjdk/security/java.security` file, or in an alternate file that can be specified to a Java application by setting the `java.security.properties` value. For example, if your java application is called `myapp.java`, you can invoke it as shown below to specify an additional security properties file:

```
java -Djava.security.properties=file://$HOME/java.security
```

When using just one equals sign ("`=`") as above, the settings from the specified file are appended to the existing ones. If, however, we use two equals signs:

```
java -Djava.security.properties==file://$HOME/java.security
```

Then the settings from `$HOME/java.security` completely override the ones from the main file at `/etc/java-11-openjdk/security/java.security`.

To disable the ability to specify an additional properties file in the command line, set the key `security.overridePropertiesFile` to `false` in `/etc/java-11-openjdk/security/java.security`.

## Practical examples

Let's see some practical examples of how we can use the configuration file to tweak the default cryptographic settings of a Java application.

The examples will use the Java `keytool` utility for the client part, and a simple OpenSSL test server on localhost for the server part. Since OpenSSL has its own separate configuration, it won't be affected by the changes we make to the Java security settings.

## Test setup

To use the test OpenSSL server, we will have to generate a certificate and key for it to use, and then import that into the Java Certificate Authority (CA) database so it can be trusted.

First, generate a keypair for OpenSSL:

```
openssl req -new -x509 -days 30 -nodes -subj "/CN=localhost" -out localhost.pem -keyout localhost.key
```

Now let's import this new certificate into the system-wide CA database. Execute the following commands:

```
sudo cp localhost.pem /usr/local/share/ca-certificates/localhost-test.crt
sudo update-ca-certificates
```

For our testing purposes, this is how we will launch our OpenSSL test server:

```
openssl s_server -accept 4443 -cert localhost.pem -key localhost.key | grep ^CIPHER
```

This will show the cipher that was selected for each connection, as it occurs.

The client part of our setup will be using the `keytool` utility that comes with Java, but any Java application that is capable of using SSL/TLS should suffice. We will be running the client as below:

```
keytool -J-Djava.security.properties=file://$HOME/java.security -printcert -sslserver localhost:4443 > /dev/null;echo $
```

These are the parameters:

- `-J-Djava.security.properties=...`  
This is used to point at the configuration file snippet that has our changes. It is NOT NEEDED if you are modifying `/etc/java-11-openjdk/security/java.security` instead.
- `-printcert -sslserver localhost:4443`  
Connect to a server on localhost (`-sslserver` is a parameter to `-printcert`, so we need the latter even though we are not interested in the certificate).

The rest is just to ignore all non-error output, and show us the exit status (0 for success, anything else for an error).

### Note:

`keytool` is not really intended as a tool to test SSL/TLS connections, but being part of the Java packaging makes it convenient and it's enough for our purposes.

Let's see some examples now.

## Only use TLSv1.3

Create `$HOME/java.security` with the following content:

```
jdk.tls.disabledAlgorithms=TLSv1, TLSv1.1, TLSv1.2, SSLv3, SSLv2
```

Notice that TLSv1.3 is absent.

When you then run the `keytool` utility:

```
$ keytool -J-Djava.security.properties=file://$HOME/java.security -printcert -sslserver localhost:4443 > /dev/null;echo $
0
```

The server should log:

```
$ openssl s_server -accept 4443 -key localhost.key -cert localhost.pem | grep ^CIPHER
```

```
CIPHER is TLS_AES_256_GCM_SHA384
```

That is a TLSv1.3 cipher. To really test that TLSv1.3 is the only protocol available, we can force some failures:

Force the client to try to use TLSv1.2:

```
$ keytool \
 -J-Djava.security.properties=file://$HOME/java.security \
 -J-Djdk.tls.client.protocols=TLSv1.2 \
 -printcert -sslserver localhost:4443
```

```
keytool error: java.lang.Exception: No certificate from the SSL server
```

Restart the server with the `no_tls1_3` option, disabling TLSv1.3, and run the client again as originally (without the extra TLSv1.2 option we added above):

**Server:**

```
$ openssl s_server -accept 4443 -key localhost.key -cert localhost.pem -no_tls1_3
```

```
Using default temp DH parameters
```

```
ACCEPT
```

```
ERROR
```

```
40676E75B37F0000:error:0A000102:SSL routines:tls_early_post_process_client_hello:unsupported protocol:../ssl/statem/statem_srvr.c:102
```

```
shutting down SSL
```

```
CONNECTION CLOSED
```

**Client:**

```
$ keytool -J-Djava.security.properties=file://$HOME/java.security -printcert -sslserver localhost:4443
```

```
keytool error: java.lang.Exception: No certificate from the SSL server
```

To get a little bit more verbosity in the `keytool` output, you can add the `-v` option. Then, inside the traceback that we get back, we can see an error message about an SSL protocol version:

```
$ keytool -J-Djava.security.properties=file://$HOME/java.security -printcert -sslserver localhost:4443 -v
```

```
keytool error: java.lang.Exception: No certificate from the SSL server
```

```
java.lang.Exception: No certificate from the SSL server
```

```
 at java.base/sun.security.tools.keytool.Main.doPrintCert(Main.java:2981)
```

```
 at java.base/sun.security.tools.keytool.Main.doCommands(Main.java:1292)
```

```
 at java.base/sun.security.tools.keytool.Main.run(Main.java:421)
```

```
 at java.base/sun.security.tools.keytool.Main.main(Main.java:414)
```

```
Caused by: javax.net.ssl.SSLHandshakeException: Received fatal alert: protocol_version
```

```
...
```

## Prevent a specific cipher

The [Java Security Standard Algorithm Names](#) page lists the names of all the cryptographic algorithms recognised by Java. If you want to prevent a specific algorithm from being used, you can list it in the `java.security` file.

In the previous example where we allowed only TLSv1.3 we saw that the negotiated algorithm was `TLS_AES_256_GCM_SHA384`. But what happens if we block it?

Add `TLS_AES_256_GCM_SHA384` to `jdk.tls.disabledAlgorithms` in `$HOME/java.security` like this:

```
jdk.tls.disabledAlgorithms=TLSv1, TLSv1.1, TLSv1.2, SSLv3, SSLv2, TLS_AES_256_GCM_SHA384
```

If we run our client now:

```
$ keytool -J-Djava.security.properties=file://$HOME/java.security -printcert -sslserver localhost:4443 > /dev/null; echo
```

```
0
```

The server will show the new selected cipher:

```
$ openssl s_server -accept 4443 -key localhost.key -cert localhost.pem | grep ^CIPHER
```

```
CIPHER is TLS_AES_128_GCM_SHA256
```

## Blocking cipher “elements”

With TLSv1.3 ciphers, we must list the exact cipher name. With TLSv1.2 ciphers, however, there is a bit more flexibility and we can list just an “element”.

For example, let’s check out a case where we only allow TLSv1.2 for simplicity by once again modifying `$HOME/java.security`:

```
jdk.tls.disabledAlgorithms=TLSv1, TLSv1.1, TLSv1.3, SSLv2, SSLv3
```

When we run the client:



```
$ keytool -J-Djava.security.properties=file://$HOME/java.security -printcert -sslserver localhost:4443 > /dev/null; echo
```

```
0
```

The server reports:

```
$ openssl s_server -accept 4443 -key localhost.key -cert localhost.pem | grep ^CIPHER
```

```
CIPHER is ECDHE-RSA-AES256-GCM-SHA384
```

We can block just the AES256 component by using:

```
jdk.tls.disabledAlgorithms=TLSv1, TLSv1.1, TLSv1.3, SSLv2, SSLv3, AES_256_GCM
```

And now the server reports:

```
$ openssl s_server -accept 4443 -key localhost.key -cert localhost.pem | grep ^CIPHER
```

```
CIPHER is ECDHE-RSA-CHACHA20-POLY1305
```

## References

- [Additional information on Java's Cryptographic Algorithms settings](#)
- [Java Security Standard Algorithm Names](#)
- [Keytool upstream documentation](#)
- [java.security file with comments](#) – links to the section which explains the crypto algorithm restrictions)

Domain Name System Security Extensions (DNSSEC), which provides a set of security features to DNS, is a broad topic. In this article, we will briefly show DNSSEC validation happening on a `bind9` DNS server, and then introduce the topic of how we can disable certain cryptographic algorithms from being used in this validation.

## DNSSEC validation

Out of the box, the BIND 9 DNS server is configured to try to use DNSSEC whenever it's available, doing all the validation checks automatically. This is done via the `dnssec-validation` setting in `/etc/bind/named.conf.options`:

```
options {
 (...)
 dnssec-validation auto;
 (...)
};
```

This can be quickly checked with the help of `dig`. Right after you installed `bind9`, you can probe ask it about the `isc.org` domain:

```
$ dig @127.0.0.1 isc.org +dnssec +multiline

; <<>> DiG 9.18.12-0ubuntu0.22.04.1-Ubuntu <<>> @127.0.0.1 isc.org +dnssec +multiline
; (1 server found)
;; global options: +cmd
;; Got answer:
;; ->>HEADER<<- opcode: QUERY, status: NOERROR, id: 57669
;; flags: qr rd ra ad; QUERY: 1, ANSWER: 2, AUTHORITY: 0, ADDITIONAL: 1

;; OPT PSEUDOSECTION:
; EDNS: version: 0, flags: do; udp: 1232
; COOKIE: 71aa6b4e4ca6bb4b01000000643fee81edf0840b48d28d44 (good)
;; QUESTION SECTION:
;isc.org. IN A

;; ANSWER SECTION:
isc.org. 300 IN A 149.20.1.66
isc.org. 300 IN RRSIG A 13 2 300 (
 20230510161711 20230410161439 27566 isc.org.
 EUA5QPEjtVC0scPsvf1c/EIBKHRpS8ektiWi0qk6nb3t
 JhJA9uCr3e0KNAcc3WDU+wJzEvqDyJrLZoELqT/pQ==)

;; Query time: 740 msec
```

```
;; SERVER: 127.0.0.1#53(127.0.0.1) (UDP)
;; WHEN: Wed Apr 19 13:37:05 UTC 2023
;; MSG SIZE rcvd: 183
```

We can see that a RRSIG DNSSEC record was returned, but the key information in this output is the `ad` flag near the top. That stands for “authenticated data”, and means that the DNSSEC records in the response were validated.

To see an example where this verification fails, we can use the `www.dnssec-failed.org` domain, which is specially crafted for this:

```
$ dig @127.0.0.1 www.dnssec-failed.org +dnssec +multiline

;<<>> DiG 9.18.12-0ubuntu0.22.04.1-Ubuntu <<>> @127.0.0.1 www.dnssec-failed.org +dnssec +multiline
; (1 server found)
;; global options: +cmd
;; Got answer:
;; ->>HEADER<<- opcode: QUERY, status: SERVFAIL, id: 56056
;; flags: qr rd ra; QUERY: 1, ANSWER: 0, AUTHORITY: 0, ADDITIONAL: 1

;; OPT PSEUDOSECTION:
; EDNS: version: 0, flags: do; udp: 1232
; COOKIE: 541f6c66a216acdb01000000643fef9ebb21307fee2ea0e3 (good)
;; QUESTION SECTION:
;www.dnssec-failed.org. IN A

;; Query time: 1156 msec
;; SERVER: 127.0.0.1#53(127.0.0.1) (UDP)
;; WHEN: Wed Apr 19 13:41:50 UTC 2023
;; MSG SIZE rcvd: 78
```

Here we see that:

- There is no IN A IP address shown in the reply
- The status is SERVFAIL
- There is no `ad` flag

In the `bind9` logs, we will see DNSSEC validation errors:

```
$ journalctl -u named.service -n 10
```

```
Apr 19 13:41:50 j named[3018]: validating dnssec-failed.org/DNSKEY: no valid signature found (DS)
Apr 19 13:41:50 j named[3018]: no valid RRSIG resolving 'dnssec-failed.org/DNSKEY/IN': 68.87.76.228#53
Apr 19 13:41:50 j named[3018]: broken trust chain resolving 'www.dnssec-failed.org/A/IN': 68.87.85.132#53
(...)
```

We can run `dig` with the `+cd` command line parameter which disables this verification, but notice that still we don't get the `ad` flag in the reply:

```
$ dig @127.0.0.1 www.dnssec-failed.org +dnssec +multiline +cd

;<<>> DiG 9.18.12-0ubuntu0.22.04.1-Ubuntu <<>> @127.0.0.1 www.dnssec-failed.org +dnssec +multiline +cd
; (1 server found)
;; global options: +cmd
;; Got answer:
;; ->>HEADER<<- opcode: QUERY, status: NOERROR, id: 42703
;; flags: qr rd ra cd; QUERY: 1, ANSWER: 3, AUTHORITY: 0, ADDITIONAL: 1

;; OPT PSEUDOSECTION:
; EDNS: version: 0, flags: do; udp: 1232
; COOKIE: 3d6a4f4ff0014bdc01000000643ff01c3229ed7d798c5f8d (good)
;; QUESTION SECTION:
;www.dnssec-failed.org. IN A

;; ANSWER SECTION:
www.dnssec-failed.org. 7031 IN A 68.87.109.242
www.dnssec-failed.org. 7031 IN A 69.252.193.191
www.dnssec-failed.org. 7074 IN RRSIG A 5 3 7200 (
```

```
20230505145108 20230418144608 44973 dnssec-failed.org.
R6/u+5Gv3rH93g08uNvz3sb9ErQNuVFKu6W5rtUleXF/
vkqJXbNe8grMuiV6Y+CNEP6jRBu0j0BPncb5cXbfcfmo
CoV0jpsLySxt4D1EUl4yByWm2ZAdXRrk6A8SaldIdDv8
9t+FguTdQrZv9Si+afKrLyC7L/mltXmllq3stDI=)
```

```
;; Query time: 0 msec
;; SERVER: 127.0.0.1#53(127.0.0.1) (UDP)
;; WHEN: Wed Apr 19 13:43:56 UTC 2023
;; MSG SIZE rcvd: 287
```

## Restricting DNSSEC algorithms

It's possible to limit the cryptographic algorithms used by BIND to validate DNSSEC records. This is done via two configuration settings, located inside the `options { }` block of `/etc/named/named.conf.options`:

- `disable-algorithms "<domain>" { a; b; ... };`  
Disables the listed algorithms for the specified domain and all subdomains of it.
- `disable-ds-digests "<domain>" { a; b; ... };`  
Disables the listed digital signature digests for the specified domain and all subdomains of it.

For example, the following disables RSAMD5, DSA and GOST for all zones:

```
disable-algorithms "." {
 RSAMD5;
 DSA;
};
disable-ds-digest "." {
 GOST;
};
```

The list of algorithm names can be obtained at [DNSSEC Algorithm Numbers](#), in the **Mnemonic** column of the **Available Formats** table. The algorithm number is also standardised, and is part of the DNSSEC records.

For example, if we go back to the `dig` result from before where we inspected the `isc.org` domain, the *RRSIG* record had this (showing just the first line for brevity):

```
isc.org. 300 IN RRSIG A 13 2 300 (
```

In that record, the number 13 is the algorithm number, and in this case it means the algorithm ECDSAP256SHA256 was used.

Just to see how BIND would react to an algorithm being disabled, let's temporarily add ECDSAP256SHA256 to the list of disabled algorithms:

```
disable-algorithms "." {
 RSAMD5;
 DSA;
 ECDSAP256SHA256;
};
```

And restart BIND:

```
sudo systemctl restart bind9.service
```

Now the `ad` flag is gone, meaning that this answer wasn't validated:

```
$ dig @127.0.0.1 isc.org +dnssec +multiline

; <<>> DiG 9.18.1-lubuntu1-Ubuntu <<>> @127.0.0.1 isc.org +dnssec +multiline
; (1 server found)
;; global options: +cmd
;; Got answer:
;; ->HEADER<<- opcode: QUERY, status: NOERROR, id: 43893
;; flags: qr rd ra; QUERY: 1, ANSWER: 2, AUTHORITY: 0, ADDITIONAL: 1

;; OPT PSEUDOSECTION:
; EDNS: version: 0, flags: do; udp: 1232
; COOKIE: 6527ce585598025d01000000643ff8fa02418ce38af13fa7 (good)
```

```
;; QUESTION SECTION:
isc.org. IN A

;; ANSWER SECTION:
isc.org. 300 IN A 149.20.1.66
isc.org. 300 IN RRSIG A 13 2 300 (
 20230510161711 20230410161439 27566 isc.org.
 EUA5QPEjtVC0scPsvf1c/EIBKHRpS8ektiWi0qk6nb3t
 JhJAt9uCr3e0KNAcc3WDU+wJzEvqDyJrLZoELqT/pQ==)

;; Query time: 292 msec
;; SERVER: 127.0.0.1#53(127.0.0.1) (UDP)
;; WHEN: Wed Apr 19 14:21:46 UTC 2023
;; MSG SIZE rcvd: 183
```

The logs only say there was no valid signature found:

```
Apr 19 14:23:01 j-bind9 named[2786]: validating isc.org/A: no valid signature found
```

Note this is different from rejecting the response: it just means that this response is being treated as if it didn't have any DNSSEC components in it, or in other words, it's treated as "insecure".

In general, as always with cryptography, be careful with which algorithms you decide to disable and remove from DNSSEC validation, as such errors can be hard to diagnose. To help with troubleshooting, the Internet Systems Consortium (ISC) has published a very extensive DNSSEC guide, which contains a detailed troubleshooting section (see below).

**Note:**

Remember now to remove the disabling of ECDSAP256SHA256 from `/etc/bind/named.conf.options` and restart BIND 9. This change was just a quick test!

## References

- [ISC's DNSSEC Guide](#)
- [DNSSEC troubleshooting section of the ISC DNSSEC guide](#)
- [Standard algorithms used for DNSSEC](#)

Establishing an SSH connection to a remote service involves multiple stages. Each one of these stages will use some form of encryption, and there are configuration settings that control which cryptographic algorithms can be used at each step.

The default selection of algorithms for each stage should be good enough for the majority of deployment scenarios. Sometimes, however, a compliance rule, or a set of legacy servers, or something else, requires a change in this selection. Perhaps a legacy system or piece of hardware that is still in production is not compatible with the current encryption schemes and requires legacy algorithms to be enabled again. Or a compliance rule that isn't up-to-date with the current crypto standards doesn't allow a more advanced cipher.

**WARNING:**

Be careful when restricting cryptographic algorithms in SSH, specially on the server side. You can inadvertently lock yourself out of a remote system!

## Algorithm configuration general rules

Most of the configuration options that take a list of cryptographic algorithms follow a defined set of rules. The first algorithm in the list that the *client* offers to the server, which matches an offer from the server, is what will be selected. The rules are as follows:

- The lists are algorithm names separated by commas. For example, `Ciphers aes128-gcm@openssh.com,aes256-gcm@openssh.com` will replace the current set of ciphers with the two named algorithms.
- Instead of specifying the full list, which will replace the existing default one, some manipulations are allowed. If the list starts with:

– +

The specified algorithm(s) will be appended to the end of the default set. For example, `MACs +hmac-sha2-512,hmac-sha2-256` will append *both* Message Authentication Code (MAC) algorithms to the end of the current set.

- -  
The specified algorithm(s) will be removed from the default set. For example, `KexAlgorithms -diffie-hellman-group1-sha1,diffie-hellman-group14-sha1` will remove *both* key exchange algorithms from the current set.
- ^  
The specified ciphers will be placed at the beginning of the default set. For example, `PubkeyAcceptedAlgorithms ^ssh-ed25519,ecdsa-sha2-nistp256` will move *both* signature algorithms to the start of the set.
- Wildcards (\*) are also allowed, but be careful to not inadvertently include or exclude something that wasn't intended.

With rare exceptions, the list of algorithms can be queried by running `ssh -Q <config>`, where `<config>` is the configuration setting name. For example, `ssh -Q ciphers` will show the available list of ciphers.

**Note:**

The output of the `ssh -Q <name>` command will not take into consideration the configuration changes that may have been made. It cannot therefore be used to test the crypto configuration changes.

## Configuration settings

It's not the goal of this documentation to repeat the excellent upstream documentation (see references). Instead, we will show the configuration options, and some examples of how to use them.

Here are the configuration settings that control the cryptographic algorithms selection. Unless otherwise noted, they apply to both the server and the client.

- **Ciphers**  
List of symmetric ciphers. Examples include `aes256-ctr` and `chacha20-poly1305@openssh.com`.
- **MACs**  
List of Message Authentication Code algorithms, used for data integrity protection. The `-etm` versions calculate the MAC after encryption and are considered safer. Examples include `hmac-sha2-256` and `hmac-sha2-512-etm@openssh.com`.
- **GSSAPIKexAlgorithms**  
This option is not available in OpenSSH upstream, and is [provided via a patch](#) that Ubuntu and many other Linux Distributions carry. It lists the key exchange (kex) algorithms that are offered for Generic Security Services Application Program Interface (GSSAPI) key exchange, and only applies to connections using GSSAPI. Examples include `gss-gex-sha1-` and `gss-group14-sha256-`.
- **KexAlgorithms**  
List of available key exchange (kex) algorithms. Examples include `curve25519-sha256` and `sntrup761x25519-sha512@openssh.com`.
- **HostKeyAlgorithms**  
This is a *server-only* configuration option. It lists the available host key signature algorithms that the server offers. Examples include `ssh-ed25519-cert-v01@openssh.com` and `ecdsa-sha2-nistp521-cert-v01@openssh.com`.
- **PubkeyAcceptedAlgorithms**  
List of signature algorithms that will be accepted for public key authentication. Examples include `ssh-ed25519-cert-v01@openssh.com` and `rsa-sha2-512-cert-v01@openssh.com`.
- **CASignatureAlgorithms**  
List of algorithms that certificate authorities (CAs) are allowed to use to sign certificates. Certificates signed using any other algorithm will not be accepted for public key or host-based authentication. Examples include `ssh-ed25519` and `ecdsa-sha2-nistp384`.

To check what effect a configuration change has on the server, it's helpful to use the `-T` parameter and `grep` the output for the configuration key you want to inspect. For example, to check the current value of the `Ciphers` configuration setting after having set `Ciphers ^3des-cbc` in `sshd_config`:

```
$ sudo sshd -T | grep ciphers
```

```
ciphers 3des-cbc,chacha20-poly1305@openssh.com,aes128-ctr,aes192-ctr,aes256-ctr,aes128-gcm@openssh.com,aes256-gcm@openssh.com
```

The output will include changes made to the configuration key. There is no need to restart the service.

## OpenSSH examples

Here are some examples of how the cryptographic algorithms can be selected in OpenSSH.

### Which cipher was used?

One way to examine which algorithm was selected is to add the `-v` parameter to the `ssh` client.

For example, assuming password-less public key authentication is being used (so no password prompt), we can use this command to initiate the connection and exit right away:

```
$ ssh -v <server> exit 2>&1 | grep "cipher:"
```

```
debug1: kex: server->client cipher: chacha20-poly1305@openssh.com MAC: <implicit> compression: none
debug1: kex: client->server cipher: chacha20-poly1305@openssh.com MAC: <implicit> compression: none
```

In the above case, the `chacha20` cipher was automatically selected. We can influence this decision and only offer one algorithm:

```
$ ssh -v -c aes128-ctr <server> exit 2>&1 | grep "cipher:"
```

```
debug1: kex: server->client cipher: aes128-ctr MAC: umac-64-etm@openssh.com compression: none
debug1: kex: client->server cipher: aes128-ctr MAC: umac-64-etm@openssh.com compression: none
```

For the other stages in the `ssh` connection, like key exchange, or public key authentication, other expressions for the `grep` command have to be used. In general, it will all be visible in the full `-v` output.

### Remove AES 128 from server

Let's configure an OpenSSH server to only offer the AES 256 bit variant of symmetric ciphers for an `ssh` connection.

First, let's see what the default is:

```
$ sudo sshd -T | grep ciphers
```

```
ciphers chacha20-poly1305@openssh.com,aes128-ctr,aes192-ctr,aes256-ctr,aes128-gcm@openssh.com,aes256-gcm@openssh.com
```

Now let's make our change. On the server, we can edit `/etc/ssh/sshd_config` and add this line:

```
Ciphers -aes128*
```

And then check what is left:

```
$ sudo sshd -T | grep ciphers
```

```
ciphers chacha20-poly1305@openssh.com,aes192-ctr,aes256-ctr,aes256-gcm@openssh.com
```

To activate the change, `ssh` has to be restarted:

```
$ sudo systemctl restart ssh.service
```

After we restart the service, clients will no longer be able to use AES 128 to connect to it:

```
$ ssh -c aes128-ctr <server>
```

```
Unable to negotiate with 10.0.102.49 port 22: no matching cipher found. Their offer: chacha20-poly1305@openssh.com,aes192-ctr,aes256-ctr,aes256-gcm@openssh.com
```

### Prioritize AES 256 on the client

If we just want to prioritise a particular cipher, we can use the `^` character to move it to the front of the list, without disabling any other cipher:

```
$ ssh -c ^aes256-ctr -v <server> exit 2>&1 | grep "cipher:"
```

```
debug1: kex: server->client cipher: aes256-ctr MAC: umac-64-etm@openssh.com compression: none
debug1: kex: client->server cipher: aes256-ctr MAC: umac-64-etm@openssh.com compression: none
```

In this way, if the server we are connecting to does not support AES 256, the negotiation will pick up the next one from the list. If we do that on the server via `Ciphers -aes256*`, this is what the same client, with the same command line, now reports:

```
$ ssh -c ^aes256-ctr -v <server> exit 2>&1 | grep "cipher:"
```

```
debug1: kex: server->client cipher: chacha20-poly1305@openssh.com MAC: <implicit> compression: none
debug1: kex: client->server cipher: chacha20-poly1305@openssh.com MAC: <implicit> compression: none
```

## References

- [OpenSSH upstream documentation index](#)
- [Ubuntu sshd\\_config man page](#)
- [Ubuntu ssh\\_config man page](#)

Debugging TLS/SSL connections and protocols can be daunting due to their complexity. Here are some troubleshooting tips.

## Separate client and server

Whenever testing TLS/SSL connections over the network, it's best to really separate the client and the server. Remember that the crypto library configuration file is read by the library, not just by a server or a client. It's read by both. Therefore having separate systems acting as clients and servers, with their own configuration files, makes things simpler to analyse.

## Tools

Here are some tools to help troubleshooting a TLS/SSL configuration.

### OpenSSL server and client apps

The OpenSSL server and client tools are very handy to quickly bring up a server with a selection of ciphers and protocols and test it with a client. Being part of OpenSSL, these tools will also initialize the library defaults directly from the OpenSSL config file, so they are very useful to test your configuration changes.

To bring up an OpenSSL server, a certificate with a private key is needed. There are many ways to generate a pair, and here is a quick one:

```
$ openssl req -new -x509 -nodes -days 30 -out myserver.pem -keyout myserver.key
```

Answer the questions as you prefer, but the one that needs special attention is the *commonName* (*CN*) one, which should match the hostname of this server. Then bring up the OpenSSL server with this command:

```
$ openssl s_server -cert myserver.pem -key myserver.key
```

That will bring up a TLS/SSL server on port 4433. Extra options that can be useful:

- `-port N`: Set a port number. Remember that ports below 1024 require root privileges, so use `sudo` if that's the case.
- `-www`: Will send back a summary of the connection information, like ciphers used, protocols, etc.
- `-tls1_2`, `-tls1_3`, `-no_tls1_3`, `-no_tls1_2`: Enable only the mentioned protocol version, or, with the `no_` prefix variant, disable it.
- `-cipher <string>`: Use the specified cipher string for TLS1.2 and lower.
- `-ciphersuite <string>`: Use the specified string for TLS1.3 ciphers.

The client connection tool can be used like this when connecting to server:

```
$ echo | openssl s_client -connect server:port 2>&1 | grep ^New
```

That will generally show the TLS version used, and the selected cipher:

```
$ echo | openssl s_client -connect j-server.lxd:443 2>&1 | grep ^New
New, TLSv1.3, Cipher is TLS_AES_256_GCM_SHA384
```

The ciphers and protocols can also be selected with the same command line options as the server:

```
$ echo | openssl s_client -connect j-server.lxd:443 -no_tls1_3 2>&1 | grep ^New
New, TLSv1.2, Cipher is ECDHE-RSA-AES256-GCM-SHA384
```

```
$ echo | openssl s_client -connect j-server.lxd:443 -no_tls1_3 2>&1 -cipher DEFAULT:-AES256 | grep ^New
New, TLSv1.2, Cipher is ECDHE-RSA-CHACHA20-POLY1305
```

## The `sslsan` tool

The `sslsan` tool comes from a package with the same name, and it will scan a server and list the supported algorithms and protocols. It's super useful for determining if your configuration has really disabled or enabled a particular cipher or TLS version.

To use the tool, point it at the server you want to scan:

```
$ sslscan j-server.lxd
```

And you will get a report of the ciphers and algorithms supported by that server. [Consult its manpage](#) for more details.

## References

- [OpenSSL s\\_server](#)
- [OpenSSL s\\_client](#)
- [sslsan](#)
- <https://badssl.com>: excellent website that can be used to test a client against a multitude of certificates, algorithms, key sizes, protocol versions, and more.

Computer networks are often comprised of diverse systems. While operating a network made up entirely of Ubuntu desktop and server computers would definitely be fun, some network environments require both Ubuntu and Microsoft Windows systems working together in harmony.

This is where [Samba](#) comes in! Samba provides various tools for configuring your Ubuntu Server to share network resources with Windows clients. In this overview, we'll look at some of the key principles, how to install and configure the tools available, and some common Samba use cases.

## Samba functionality

There are several services common to Windows environments that your Ubuntu system needs to integrate with in order to set up a successful network. These services share data and configuration details of the computers and users on the network between them, and can each be classified under one of three main categories of functionality.

### File and printer sharing services

These services use the Server Message Block (SMB) protocol to facilitate the sharing of files, folders, volumes, and the sharing of printers throughout the network.

- **File server**  
Samba can be [configured as a file server](#) to share files with Windows clients - our guide will walk you through that process.
- **Print server**  
Samba can also be [configured as a print server](#) to share printer access with Windows clients, as detailed in this guide.

### Directory services

These services share vital information about the computers and users of the network. They use technologies like the Lightweight Directory Access Protocol (LDAP) and Microsoft Active Directory.

- **Microsoft Active Directory**  
An Active Directory domain is a collection of users, groups, or hardware components within a Microsoft Active Directory network. This guide will show you how to set up your server as a [member of an Active Directory domain](#).
- **NT4 Domain Controller** (*deprecated*)  
This guide will show you how to configure your Samba server to appear as a [Windows NT4-style domain controller](#).
- **OpenLDAP backend** (*deprecated*)  
This guide will show you how to integrate Samba with [LDAP in Windows NT4 mode](#).



## Authentication and access

These services establish the identity of a computer or network user, and determine the level of access that should be granted to the computer or user. The services use such principles and technologies as file permissions, group policies, and the Kerberos authentication service.

- **Share access controls**

This article provides more details on controlling access to shared directories.

- **AppArmor profile for Samba**

This guide will briefly cover how to [set up a profile for Samba](#) using the Ubuntu security module, AppArmor.

Our *reference* section is used for quickly checking what software and commands are available, and how to interact with various tools.

---

### Reference

---

#### Cloud images

- [Introduction](#)
- [Amazon EC2](#)
- [Google Compute Engine \(GCE\)](#)
- [Microsoft Azure](#)

#### Multipath

- [Introduction](#)
- [Configuration](#)
- [Setup](#)
- [Usage and debug](#)

#### Security

- [Introduction](#)
- [Users](#)
- [Smart cards](#)
- [SSH](#)
- [AppArmor](#)
- [Firewall](#)
- [Certificates](#)
- [CA trust store](#)
- [Console](#)

#### Virtualisation

- [Introduction](#)
- [QEMU](#)
- [libvirt](#)
- [OpenStack](#)
- [Multipass](#)
- [uvtool](#)
- [Virtualisation tools](#)

#### Containers

- [LCD](#)
- [LXC](#)

#### High Availability

- [Introduction](#)
- [Pacemaker - resource agents](#)
- [Pacemaker - fence agents](#)
- [Distributed Replicated Block Device \(DRBD\)](#)
- [Ubuntu HA - Migrate from crmsh to pcs](#)

#### Databases

- [Introduction](#)
- [MySQL](#)
- [PostgreSQL](#)

#### Monitoring

- [Logging, Monitoring and Alerting \(LMA\)](#)
- [Nagios and Munin](#)
- [Tools - Logwatch](#)

#### Backups

- [Introduction](#)
- [Archive rotation](#)
- [Bacula](#)

---

Reference	
	Shell scripts Rsnapshot
Mail Services	Introduction Dovecot Exim4 Postfix
Web Services	Introduction Apache Squid proxy server LAMP applications PHP programming Ruby on Rails programming
Other Services	CUPS Debuginfod Debuginfod FAQ Domain Name Service (DNS) FTP iSCSI NFS OpenSSH OpenVPN gitolite VPN clients
Tools	byobu etckeeper munin nagios pam_motd Puppet

---

Alternatively, our *Tutorials* section contain step-by-step directions to help outline what Ubuntu Server is capable of while helping you achieve specific aims, such as installing the operating system or customizing software.

If you have a specific goal, but are already familiar with Ubuntu Server, take a look at our *How-to* guides. These have more in-depth detail and can be applied to a broader set of applications.

Finally, for a better understanding of how Ubuntu Server works and how it can be used and configured, our *Explanation* section enables you to expand your knowledge of the operating system and additional software.

Canonical produces a variety of cloud-specific images, which are available directly via the clouds themselves, as well as on <https://cloud-images.ubuntu.com>.

## Public clouds

### Compute offerings

Users can find Ubuntu images for virtual machines and bare-metal offerings published directly to the following clouds:

- [Amazon Elastic Compute Cloud \(EC2\)](#)
- [Google Cloud Engine \(GCE\)](#)
- IBM Cloud
- [Microsoft Azure](#)
- Oracle Cloud

### Container offerings

Ubuntu images are also produced for a number of container offerings:

- [Amazon Elastic Kubernetes Service \(EKS\)](#)
- [Google Kubernetes Engine \(GKE\)](#)

## Private clouds

On [cloud-images.ubuntu.com](https://cloud-images.ubuntu.com), users can find standard and minimal images for the following:

- Hyper-V
- KVM
- OpenStack
- Vagrant
- VMware

## Release support

Cloud images are published and supported throughout the [lifecycle of an Ubuntu release](#). During this time images can receive all published security updates and bug fixes.

For users wanting to upgrade from one release to the next, the recommended path is to launch a new image with the desired release and then migrate any workload or data to the new image.

Some cloud image customisation must be applied during image creation, which would be missing if an in-place upgrade were performed. For that reason, in-place upgrades of cloud images are not recommended.

Amazon Web Service's Elastic Compute Cloud (EC2) provides a platform for deploying and running applications.

## Images

On EC2, cloud images are referred to as Amazon Machine Images (AMIs). Canonical produces a wide variety of images to support numerous features found on EC2:

- Generally, all images use Elastic Block Storage (EBS) and HVM virtualisation types. Older releases may also support PV and instance-store, but users benefit from the newer storage and virtualisation technologies.
- Standard server images, as well as minimal images for amd64, and arm64 images for the standard server set.
- Daily (untested) and release images are published.

## Find images with SSM

The AWS Systems Manager (SSM) agent is used by Canonical to store the latest AMI release versions for EC2. This provides users with a programmatic method of querying for the latest AMI ID.

Canonical stores SSM parameters under `/aws/service/canonical/`. To find the latest AMI ID, users can use the AWS CLI:

```
aws ssm get-parameters --names \
 /aws/service/canonical/ubuntu/server/20.04/stable/current/amd64/hvm/ebs-gp2/ami-id
```

The path follows this format:

```
ubuntu/$PRODUCT/$RELEASE/stable/current/$ARCH/$VIRT_TYPE/$VOL_TYPE/ami-id
```

- **PRODUCT**: server or server-minimal
- **RELEASE**: focal, 20.04, bionic, 18.04, xenial, or 16.04
- **ARCH**: amd64 or arm64
- **VIRT\_TYPE**: pv or hvm
- **VOL\_TYPE**: ebs-gp2, ebs-io1, ebs-standard, or instance-store

The given serial for an image (e.g., 20210222) is also uploaded in place of current:

```
ubuntu/$PRODUCT/$RELEASE/stable/$SERIAL/$ARCH/$VIRT_TYPE/$VOL_TYPE/ami-id
```

For more details on SSM check out [this Discourse thread](#).

## Ownership verification

Users can verify that an AMI was published by Canonical by ensuring the `OwnerId` field of an image is `099720109477` (in the default partition). For the GovCloud partition, the `OwnerId` field is `513442679011`. For the China partition, the `OwnerId` field is `837727238323`. This ID is stored in SSM and is discoverable by running:

```
aws ssm get-parameters --names /aws/service/canonical/meta/publisher-id
```

With the value returned by that command, users can then run the `describe-images` command against an AMI ID and verify the `OwnerId` field matches the above ID:

```
aws ec2 describe-images --image-ids $AMI_ID
```

Note that listings on the AWS Marketplace will always show the `OwnerId` as Amazon (e.g. 67959333241). In these cases, users can verify the Amazon ID and look for `aws-marketplace/ubuntu` in the `ImageLocation` field.

### Image locator

Canonical also produces an [Ubuntu Cloud Image Finder](#) where users can filter down based on a variety of criteria such as region or release, etc.

## AWS EKS

Amazon’s Elastic Kubernetes Service (EKS) is a managed Kubernetes service provided by AWS that lets users run Kubernetes applications in the cloud or on-premises.

Canonical provides [minimized Ubuntu images customised for use with EKS](#). These are fully tested release images that cover all Kubernetes versions supported by the EKS service.

The latest EKS AMI ID can be found in the SSM parameter store:

```
aws ssm get-parameters --names /aws/service/canonical/ubuntu/eks/20.04/1.21/stable/current/amd64/hvm/eks-gp2/ami-id
```

The path follows this format:

```
ubuntu/eks/$RELEASE/$K8S_VERSION/stable/current/$ARCH/$VIRT_TYPE/$VOL_TYPE/ami-id
```

For newer Kubernetes versions ( $\geq 1.20$ ), there are also *arm64* images available (in addition to the *amd64* images).

## AWS Marketplace

AWS Marketplace is a digital catalogue with thousands of software listings from independent software vendors that make it easy to find, test, buy, and deploy software that runs on AWS.

Canonical [maintains image listings](#) for recent Ubuntu releases on AWS Marketplace, including images in minimal and arm64 flavors.

Those images can also be found in the SSM parameter store:



```
aws ssm get-parameter --name /aws/service/marketplace/<identifier>/latest
```

Customers can also use the AWS Marketplace to launch and subscribe to official Ubuntu Pro images that allow users to pay for additional support. These Ubuntu Pro images can also be found in the SSM parameter store.









Not all releases are in GovCloud at this time (a list of available products is shown below). To query GovCloud, be sure to use a GovCloud region and credentials:

```
aws --region us-gov-west-1 --profile govcloud ssm get-parameter --name /aws/service/marketplace/<identifier>/latest
```

Please use this chart to find the product identifier and availability:

Name	Architecture	identifier	GovCloud
Ubuntu 16.04 LTS	amd64	prod-aq7wy7l65auna	
Ubuntu 16.04 LTS	arm64	prod-zjzktzfox3gz6	
Ubuntu 18.04 LTS	amd64	prod-43pfd7pfsijnm	

Name	Architecture	identifier	GovCloud
Ubuntu 18.04 LTS	arm64	prod-nanaj5afkj4gq	
Minimal Ubuntu 18.04 LTS	amd64	prod-gv4aco7axss42	
Minimal Ubuntu 18.04 LTS	arm64	prod-jfs2osz6fmem4	
Ubuntu 20.04 LTS	amd64	prod-x7h6cigkuiul6	
Ubuntu 20.04 LTS	arm64	prod-gprntd234sfc	
Minimal Ubuntu 20.04 LTS	amd64	prod-df2jln3gjtups	
Minimal Ubuntu 20.04 LTS	arm64	prod-emtsb6upxf6us	
Ubuntu 22.04 LTS	amd64	prod-lfutkwiaknxsks	
Ubuntu 22.04 LTS	arm64	prod-amd2rg3s3i7tc	

Name	Architecture	identifier	GovCloud
Minimal Ubuntu 22.04 LTS	amd64	prod-smq32swynllqw	
Minimal Ubuntu 22.04 LTS	arm64	prod-zvdejcufto6ps	
Ubuntu 22.10	amd64	prod-663ryfcvanyqi	
Ubuntu 22.10	arm64	prod-aizbragkux5k2	
Minimal Ubuntu 22.10	amd64	prod-k62pbab6qb6ws	
Minimal Ubuntu 22.10	arm64	prod-haniqpk5itina	
Ubuntu 23.04	amd64	prod-5k5cl7gpbkr26	
Ubuntu 23.04	arm64	prod-ad4brywkngiv4	
Minimal Ubuntu 23.04	amd64	prod-4q2ov7d2gozxx	

Name	Architecture	identifier	GovCloud
Minimal Ubuntu 23.04	arm64	prod-wq7aqb3abhaay	
Ubuntu Pro FIPS 16.04 LTS	amd64	prod-hykkbajyverq4	
Ubuntu Pro FIPS 18.04 LTS	amd64	prod-7izp2xqnddwde	
Ubuntu Pro FIPS 20.04 LTS	amd64	prod-k6fgbnayirmrc	
Ubuntu Pro 14.04 LTS	amd64	prod-7u42cjmp5pcuo	
Ubuntu Pro 16.04 LTS	amd64	prod-f6ogoaqs7lwre	
Ubuntu Pro 18.04 LTS	amd64	prod-jlgu4232gpnwa	
Ubuntu Pro 20.04 LTS	amd64	prod-3sk4unyn4iwqu	
Ubuntu Pro 22.04 LTS	amd64	prod-uwytposjsg3du	

Name	Architecture	identifier	GovCloud
Ubuntu 20.04 LTS for EKS 1.22	amd64	prod-2m2caolrsf3dy	
Ubuntu 20.04 LTS for EKS 1.22	arm64	prod-mm6rjsecuihx4	
Ubuntu 20.04 LTS for EKS 1.23	amd64	prod-d6nzbzhqtsnc	
Ubuntu 20.04 LTS for EKS 1.23	arm64	prod-w4kdatfulfk2	
Ubuntu 20.04 LTS for EKS 1.24	amd64	prod-q56ww7nfnmv72	
Ubuntu 20.04 LTS for EKS 1.24	arm64	prod-pikds4f276lq6	
Ubuntu 20.04 LTS for EKS 1.25	amd64	prod-h232pdamfnj5w	
Ubuntu 20.04 LTS for EKS 1.25	arm64	prod-exeixbb2fbrog	
Ubuntu 20.04 LTS for EKS 1.26	amd64	prod-paebp5ekgg6uu	



Name	Architecture	identifier	GovCloud
Ubuntu 20.04 LTS for EKS 1.26	arm64	prod-lrqczh7vqe7ve	

Google Cloud Platform lets you build and host applications and websites, store data, and analyse data on Google's scalable infrastructure.

## Images

On GCE, Canonical produces standard server and minimal images for all supported releases.

### Finding images

Users can find the latest Ubuntu images on the GCE UI by selecting "Ubuntu" as the Operating System under the 'Boot Disk' settings.

For a programmatic method, users can use the `gcloud` command to find the latest release images:

```
gcloud compute images list --filter ubuntu-os-cloud
```

Daily, untested images are found under the `ubuntu-os-cloud-devel` project:

```
gcloud compute images --project ubuntu-os-cloud-devel list --filter ubuntu-os-cloud-devel
```

### Image locator

Canonical also produces an [Ubuntu Cloud Image Finder](#) where users can filter down based on a variety of criteria, such as region or release, etc.

## Latest images

### Free Long Term Support offers

To learn more about LTS versions of Ubuntu read [this article](#).

### Ubuntu 22.04 LTS - Jammy Jellyfish

Quick Start: [portal.azure.com](https://portal.azure.com)

Kind	URN
Architecture: <b>AMD64</b> Hyper-V Generation: <b>Gen1</b>	Canonical:0001-com-ubuntu-server-jammy:22_04-lts:latest
Architecture: <b>AMD64</b> Hyper-V Generation: <b>Gen2</b>	Canonical:0001-com-ubuntu-server-jammy:22_04-lts-gen2:latest
Architecture: <b>Arm64</b> Hyper-V Generation: <b>Gen2</b>	Canonical:0001-com-ubuntu-server-jammy:22_04-lts-arm64:latest

### Ubuntu 20.04 LTS - Focal Fossa

Quick Start: [portal.azure.com](https://portal.azure.com)

Kind	URN
Architecture: <b>AMD64</b> Hyper-V Generation: <b>Gen1</b>	Canonical:0001-com-ubuntu-server-focal:20_04-lts:latest
Architecture: <b>AMD64</b> Hyper-V Generation: <b>Gen2</b>	Canonical:0001-com-ubuntu-server-focal:20_04-lts-gen2:latest
Architecture: <b>Arm64</b> Hyper-V Generation: <b>Gen2</b>	Canonical:0001-com-ubuntu-server-focal:20_04-lts-arm64:latest

## Interim releases

To learn more about the difference between LTS releases and interim releases, see [this page](#).

### Ubuntu 23.04 - Lunar Lobster

Quick Start: [portal.azure.com](https://portal.azure.com)

Kind	URN
Architecture: <b>AMD64</b> Hyper-V Generation: <b>Gen1</b>	Canonical:0001-com-ubuntu-server-lunar:23_04:latest
Architecture: <b>AMD64</b> Hyper-V Generation: <b>Gen2</b>	Canonical:0001-com-ubuntu-server-lunar:23_04-gen2:latest
Architecture: <b>Arm64</b> Hyper-V Generation: <b>Gen2</b>	Canonical:0001-com-ubuntu-server-lunar:23_04-arm64:latest

### Ubuntu 22.10 - Kinetic Kudu

Quick Start: [portal.azure.com](https://portal.azure.com)

Kind	URN
Architecture: <b>AMD64</b> Hyper-V Generation: <b>Gen1</b>	Canonical:0001-com-ubuntu-server-kinetic:22_10:latest
Architecture: <b>AMD64</b> Hyper-V Generation: <b>Gen2</b>	Canonical:0001-com-ubuntu-server-kinetic:22_10-gen2:latest
Architecture: <b>Arm64</b> Hyper-V Generation: <b>Gen2</b>	Canonical:0001-com-ubuntu-server-kinetic:22_10-arm64:latest

## Ubuntu Pro Offers

To learn more about Ubuntu Pro on Azure: [Ubuntu Pro for Azure](#)

### Ubuntu Pro 22.04 LTS - Jammy Jellyfish

Quick Start: [portal.azure.com](https://portal.azure.com)

Kind	URN
Architecture: <b>AMD64</b> Hyper-V Generation: <b>Gen1</b>	Canonical:0001-com-ubuntu-pro-jammy:pro-22_04-lts:latest
Architecture: <b>AMD64</b> Hyper-V Generation: <b>Gen2</b>	Canonical:0001-com-ubuntu-pro-jammy:pro-22_04-lts-gen2:latest

### Ubuntu Pro 20.04 LTS - Focal Fossa

Quick Start: [portal.azure.com](https://portal.azure.com)

Kind	URN
Architecture: <b>AMD64</b> Hyper-V Generation: <b>Gen1</b>	Canonical:0001-com-ubuntu-pro-focal:pro-20_04-lts:latest
Architecture: <b>AMD64</b> Hyper-V Generation: <b>Gen2</b>	Canonical:0001-com-ubuntu-pro-focal:pro-20_04-lts-gen2:latest

### Ubuntu Pro 18.04 LTS - Bionic Beaver

Quick Start: [portal.azure.com](https://portal.azure.com)

Kind	URN
Architecture: <b>AMD64</b> Hyper-V Generation: <b>Gen1</b>	Canonical:0001-com-ubuntu-pro-bionic:pro-18_04-lts:latest

Kind	URN
Architecture: <b>AMD64</b> Hyper-V Generation: <b>Gen2</b>	Canonical:0001-com-ubuntu-pro-bionic:pro-18_04-lts-gen2:latest

### Confidential Compute capable offer

To learn more about Confidential Compute: [Azure confidential computing](#)

### Ubuntu CVM 20.04 LTS - Focal Fossa

Quick Start: [portal.azure.com](https://portal.azure.com)

Kind	URN
Architecture: <b>AMD64</b> Hyper-V Generation: <b>Gen2</b>	Canonical:0001-com-ubuntu-confidential-vm-focal:20_04-lts-cvm:latest

### FIPS compliant offers

To learn more about FIPS: [FIPS for Ubuntu](#)

### Ubuntu Pro FIPS 20.04 LTS - Focal Fossa

Quick Start: [portal.azure.com](https://portal.azure.com)

Kind	URN
Architecture: <b>AMD64</b> Hyper-V Generation: <b>Gen1</b>	Canonical:0001-com-ubuntu-pro-focal-fips:pro-fips-20_04:latest
Architecture: <b>AMD64</b> Hyper-V Generation: <b>Gen2</b>	Canonical:0001-com-ubuntu-pro-focal-fips:pro-fips-20_04-gen2:latest

### Ubuntu Pro FIPS 18.04 LTS - Bionic Beaver

Quick Start: [portal.azure.com](https://portal.azure.com)

Kind	URN
Architecture: <b>AMD64</b> Hyper-V Generation: <b>Gen1</b>	Canonical:0001-com-ubuntu-pro-bionic-fips:pro-fips-18_04:latest
Architecture: <b>AMD64</b> Hyper-V Generation: <b>Gen2</b>	Canonical:0001-com-ubuntu-pro-bionic-fips:pro-fips-18_04-gen2:latest

### CIS Hardened offer

To learn more about CIS compliance: [CIS compliance with Ubuntu LTS](#)

### Ubuntu Minimal Pro CIS 20.04 LTS - Focal Fossa

Quick Start: [portal.azure.com](https://portal.azure.com)

Kind	URN
Architecture: <b>AMD64</b> Hyper-V Generation: <b>Gen1</b>	Canonical:0001-com-ubuntu-pro-minimal-cis-focal:pro-cis-minimal-20_04:latest
Architecture: <b>AMD64</b> Hyper-V Generation: <b>Gen2</b>	Canonical:0001-com-ubuntu-pro-minimal-cis-focal:pro-cis-minimal-20_04-gen2:latest

### List all images published by Canonical

Canonical publishes Ubuntu images under the Canonical publisher ID. One can find all our images using this `az` command:

```
az vm image list -p Canonical --all -o table
```

Via the Portal, make sure to look for `Canonical` rather than `Ubuntu` to find the official Ubuntu images. Also, always make sure the offer is published by Canonical. **Non-Pro LTS offers are always FREE.**

Device mapper multipathing (which we will refer to as *multipath*) allows you to configure multiple input/output (I/O) paths between server nodes and storage arrays into a single device. These I/O paths are physical storage area network (SAN) connections that can include separate cables, switches, and controllers.

Multipathing aggregates the I/O paths, creating a new device that consists of those aggregated paths. This chapter provides an **introduction and a high-level overview of multipath**.

## Benefits of multipath

Multipath can be used to provide:

- **Redundancy**  
Multipath provides failover in an active/passive configuration. In an active/passive configuration, only half the paths are used at any time for I/O. If any element of an I/O path (the cable, switch, or controller) fails, multipath switches to an alternate path.
- **Improved performance**  
Multipath can be configured in active/active mode, where I/O is spread over the paths in a round-robin fashion. In some configurations, multipath can detect loading on the I/O paths and dynamically re-balance the load.

## Storage array overview

It is a very good idea to consult your storage vendor's installation guide for the recommended multipath configuration variables for your storage model. The default configuration will probably work but will likely need adjustments based on your storage setup.

## Multipath components

Component	Description
<code>dm_multipath</code> kernel module	Reroutes I/O and supports <i>failover</i> for paths and path groups.
<code>multipath</code> command	Lists and configures <i>multipath</i> devices. Normally started up with <code>/etc/rc.sysinit</code> , it can also be started manually.
<code>multipathd</code> daemon	Monitors paths; as paths fail and come back, it may initiate path group switches. Provides for iSCSI and Fibre Channel.
<code>kpartx</code> command	Creates device mapper devices for the partitions on a device. It is necessary to use this command to create a device mapper device for a partition on a device.

## Multipath setup overview

Setting up multipath is often a simple procedure, since it includes compiled-in default settings that are suitable for common multipath configurations. The basic procedure for configuring your system with multipath is as follows:

1. Install the `multipath-tools` and `multipath-tools-boot` packages.
2. Create an empty config file called `/etc/multipath.conf`.
3. Edit the `multipath.conf` file to modify default values and save the updated file.
4. Start the multipath daemon.
5. Update initial RAM disk.

For detailed setup instructions for multipath configuration see [DM-Multipath configuration](#) and [DM-Multipath setup](#).

## Multipath devices

Without multipath, each path from a server node to a storage controller is treated by the system as a separate device, even when the I/O path connects the same server node to the same storage controller. Multipath provides a way of organizing the I/O paths logically, by creating a single device on top of the underlying paths.

### Multipath device identifiers

Each multipath device has a World Wide Identifier (WWID), which is guaranteed to be globally unique and unchanging. By default, the name of a multipath device is set to its WWID. Alternatively, you can set the `user_friendly_names` option in `multipath.conf`, which causes multipath to use a *node-unique* alias of the form `mpathn` as the name.

For example, a node with two host bus adapters (HBAs) attached to a storage controller with two ports via a single unzoned FC switch sees four devices: `/dev/sda`, `/dev/sdb`, `/dev/sdc`, and `/dev/sdd`. Multipath creates a single device with a unique WWID that reroutes I/O to those four underlying devices according to the multipath configuration.

When the `user_friendly_names` configuration option is set to ‘yes’, the name of the multipath device is set to `mpathn`. When new devices are brought under the control of multipath, the new devices may be seen in two different places under the `/dev` directory: `/dev/mapper/mpathn` and `/dev/dm-n`.

- The devices in `/dev/mapper` are created early in the boot process. **Use these devices to access the multipathed devices.**
- Any devices of the form `/dev/dm-n` are for **internal use only** and should never be used directly.

You can also set the name of a multipath device to a name of your choosing by using the `alias` option in the `multipaths` section of the multipath configuration file.

**See also:**

For information on the multipath configuration defaults, including the `user_friendly_names` and `alias` configuration options, see [DM-Multipath configuration](#).

### Consistent multipath device names in a cluster

When the `user_friendly_names` configuration option is set to ‘yes’, the name of the multipath device is unique to a node, but it is not guaranteed to be the same on all nodes using the multipath device. Similarly, if you set the `alias` option for a device in the `multipaths` section of `/etc/multipath.conf`, the name is not automatically consistent across all nodes in the cluster.

This should not cause any difficulties if you use LVM to create logical devices from the multipath device, but if you require that your multipath device names be consistent in every node it is recommended that you leave the `user_friendly_names` option set to ‘no’ and that you *do not* configure aliases for the devices.

If you configure an alias for a device that you would like to be consistent across the nodes in the cluster, you should ensure that the `/etc/multipath.conf` file is the same for each node in the cluster by following the same procedure:

1. Configure the aliases for the multipath devices in the `multipath.conf` file on one machine.
2. Disable all of your multipath devices on your other machines by running the following commands as root:  

```
systemctl stop multipath-tools.service
multipath -F
```
3. Copy the `/etc/multipath.conf` file from the first machine to all other machines in the cluster.
4. Re-enable the `multipathd` daemon on all the other machines in the cluster by running the following command as root:

```
systemctl start multipath-tools.service
```

When you add a new device you will need to repeat this process.

### Multipath device attributes

In addition to the `user_friendly_names` and `alias` options, a multipath device has numerous attributes. You can modify these attributes for a specific multipath device by creating an entry for that device in the `multipaths` section of `/etc/multipath.conf`.

For information on the `multipaths` section of the multipath configuration file, see [DM-Multipath configuration](#).

### Multipath devices in logical volumes

After creating multipath devices, you can use the multipath device names just as you would use a physical device name when creating an LVM physical volume.

For example, if `/dev/mapper/mpatha` is the name of a multipath device, the following command (run as root) will mark `/dev/mapper/mpatha` as a physical volume:

```
pvcreate /dev/mapper/mpatha
```

You can use the resulting LVM physical device when you create an LVM volume group just as you would use any other LVM physical device.

**Note:**

If you try to create an LVM physical volume on a whole device on which you have configured partitions, the `pvcreate` command will fail.

When you create an LVM logical volume that uses active/passive multipath arrays as the underlying physical devices, you should include filters in the `lvm.conf` file to exclude the disks that underlie the multipath devices. This is because if the array automatically changes the active path to the passive path when it receives I/O, multipath will failover and fallback whenever LVM scans the passive path if these devices are not filtered.

For active/passive arrays that require a command to make the passive path active, LVM prints a warning message when this occurs. To filter all SCSI devices in the LVM configuration file (`lvm.conf`), include the following filter in the devices section of the file:

```
filter = ["r/block/", "r/disk/", "r/sd.*/", "a/*/"]
```

After updating `/etc/lvm.conf`, it's necessary to update the `initrd` so that this file will be copied there, where the filter matters the most – during boot.

Perform:

```
update-initramfs -u -k all
```

**Note:**

Every time either `/etc/lvm.conf` or `/etc/multipath.conf` is updated, the `initrd` should be rebuilt to reflect these changes. This is imperative when *denylists* and filters are necessary to maintain a stable storage configuration.

Before moving on with this session it is recommended that you read [Device Mapper Multipathing - Introduction](#). For consistency, we will refer here to device mapper multipathing as *multipath*.

Multipath is usually able to work out-of-the-box with most common storages. This doesn't mean the default configuration variables should be used in production: they don't treat important parameters your storage might need.

It's a good idea to consult your storage manufacturer's install guide for the Linux Multipath configuration options. Storage vendors very commonly provide the most adequate options for Linux, including minimal versions required for kernel and `multipath-tools`.

Default configuration values for DM-Multipath can be overridden by editing the `/etc/multipath.conf` file and restarting the `multipathd` service.

This chapter provides information on parsing and modifying the `multipath.conf` file and it is split into the following configuration file sections:

- Configuration file overview
- Configuration file defaults
- Configuration file blacklist & exceptions
- Configuration file multipath section
- Configuration file devices section

## Configuration file overview

The configuration file contains entries of the form:

```
<section> {
 <attribute> <value>
 ...
 <subsection> {
 <attribute> <value>
 ...
 }
}
```

The following keywords are recognised:

- **defaults**: Defines default values for attributes used whenever no values are given in the appropriate device or multipath sections.
- **blacklist**: Defines which devices should be excluded from the multipath topology discovery.
- **blacklist\_exceptions**: Defines which devices should be included in the multipath topology discovery, despite being listed in the blacklist section.
- **multipaths**: Defines the multipath topologies. They are indexed by a World Wide Identifier (WWID). Attributes set in this section take precedence **over all others**.

- `devices`: Defines the device-specific settings. Devices are identified by vendor, product, and revision.
- `overrides`: This section defines values for attributes that should override the device-specific settings for all devices.

## Configuration file defaults

Currently, the multipath configuration file ONLY includes a minor *defaults* section that sets the *user\_friendly\_names* parameter to 'yes':

```
defaults {
 user_friendly_names yes
}
```

This overwrites the default value of the *user\_friendly\_names* parameter.

All the multipath attributes that can be set in the *defaults* section of the `multipath.conf` file can be found [here in the man pages](#) with an explanation of what they mean. The attributes are:

- `verbosity`
- `polling_interval`
- `max_polling_interval`
- `reassign_maps`
- `multipath_dir`
- `path_selector`
- `path_grouping_policy`
- `uid_attrs`
- `uid_attribute`
- `getuid_callout`
- `prio`
- `prio_args`
- `features`
- `path_checker`
- `alias_prefix`
- `failback`
- `rr_min_io`
- `rr_min_io_rq`
- `max_fds`
- `rr_weight`
- `no_path_retry`
- `queue_without_daemon`
- `checker_timeout`
- `flush_on_last_del`
- `user_friendly_names`
- `fast_io_fail_tmo`
- `dev_loss_tmo`
- `bindings_file`
- `wwids_file`
- `prkeys_file`
- `log_checker_err`
- `reservation_key`
- `all_tg_pt`
- `retain_attached_hw_handler`
- `detect_prio`
- `detect_checker`
- `force_sync`
- `strict_timing`
- `deferred_remove`
- `partition_delimiter`
- `config_dir`
- `san_path_err_threshold`
- `san_path_err_forget_rate`
- `san_path_err_recovery_time`
- `marginal_path_double_failed_time`
- `marginal_path_err_sample_time`
- `marginal_path_err_rate_threshold`

- `marginal_path_err_recheck_gap_time`
- `delay_watch_checks`
- `delay_wait_checks`
- `marginal_pathgroups`
- `find_multipaths`
- `find_multipaths_timeout`
- `uxsock_timeout`
- `retrigger_tries`
- `retrigger_delay`
- `missing_uev_wait_timeout`
- `skip_kpartx`
- `disable_changed_wwid`
- `remove_retries`
- `max_sectors_kb`
- `ghost_delay`
- `enable_foreign`

**Note:**

Previously, the `multipath-tools` project provided a complete configuration file with all the most commonly used options for each of the most-used storage devices. Currently, you can see all those default options by executing `sudo multipath -t`. This will dump a used configuration file including all the embedded default options.

## Configuration file blacklist and exceptions

The blacklist section is used to exclude specific devices from the multipath topology. It is most commonly used to exclude local disks, non-multipathed, or non-disk devices.

### 1. Blacklist by devnode

The default blacklist consists of the regular expressions `"^(ram|zram|raw|loop|fd|md|dm-|sr|scd|st|dcssblk)[0-9]"` and `"^(td|hd|vd)[a-z]"`. This causes virtual devices, non-disk devices, and some other device types to be excluded from multipath handling by default.

```
blacklist {
 devnode "^(ram|zram|raw|loop|fd|md|dm-|sr|scd|st|dcssblk)[0-9]"
 devnode "^(td|hd|vd)[a-z]"
 devnode "^cciss!c[0-9]d[0-9]*"
}
```

### 2. Blacklist by wwid

Regular expression for the World Wide Identifier of a device to be excluded/included

### 3. Blacklist by device

Subsection for the device description. This subsection recognizes the *vendor* and *product* keywords. Both are regular expressions.

```
device {
 vendor "LENOVO"
 product "Universal Xport"
}
```

### 4. Blacklist by property

Regular expression for an udev property. All devices that have matching udev properties will be excluded/included. The handling of the property keyword is special, because devices must have at least one whitelisted udev property; otherwise they're treated as blacklisted, and the message "blacklisted, udev property missing" is displayed in the logs.

### 5. Blacklist by protocol

The protocol strings that multipath recognizes are `scsi:fc`, `scsi:spi`, `scsi:ssa`, `scsi:sbp`, `scsi:srp`, `scsi:iscsi`, `scsi:sas`, `scsi:adt`, `scsi:ata`, `scsi:unspec`, `ccw`, `cciss`, `nvme`, and `undef`. The protocol that a path is using can be viewed by running:

```
multipathd show paths format "%d %P"
```

### 6. Blacklist exceptions



The *blacklist\_exceptions* section is used to revert the actions of the blacklist section. This allows one to selectively include (“whitelist”) devices which would normally be excluded via the blacklist section.

```
blacklist_exceptions {
 property "(SCSI_IDENT_|ID_WWN)"
}
```

**Note:**

A common usage is to blacklist “everything” using a catch-all regular expression, and create specific *blacklist\_exceptions* entries for those devices that should be handled by *multipath-tools*.

## Configuration file multipath section

The *multipaths* section allows setting attributes of *multipath maps*. The attributes set via the multipaths section (see list below) take precedence over all other configuration settings, including those from the overrides section.

The only recognised attribute for the multipaths section is the multipath subsection. If there is more than one multipath subsection matching a given WWID, the contents of these sections are merged, and settings from later entries take precedence.

The multipath subsection recognises the following attributes:

- **wwid**: (Mandatory) World Wide Identifier. Detected multipath maps are matched against this attribute. Note that, unlike the **wwid** attribute in the blacklist section, this is not a regular expression or a substring; WWIDs must match exactly inside the multipaths section.
- **alias**: Symbolic name for the multipath map. This takes precedence over an entry for the same WWID in the *bindings\_file*.

The following attributes are optional; if not set, the default values are taken from the overrides, devices, or *defaults section*:

- **path\_grouping\_policy**
- **path\_selector**
- **prio**
- **prio\_args**
- **failback**
- **rr\_weight**
- **no\_path\_retry**
- **rr\_min\_io**
- **rr\_min\_io\_rq**
- **flush\_on\_last\_del**
- **features**
- **reservation\_key**
- **user\_friendly\_names**
- **deferred\_remove**
- **san\_path\_err\_threshold**
- **san\_path\_err\_forget\_rate**
- **san\_path\_err\_recovery\_time**
- **marginal\_path\_err\_sample\_time**
- **marginal\_path\_err\_rate\_threshold**
- **marginal\_path\_err\_recheck\_gap\_time**
- **marginal\_path\_double\_failed\_time**
- **delay\_watch\_checks**
- **delay\_wait\_checks**
- **skip\_kpartx**
- **max\_sectors\_kb**
- **ghost\_delay**

Example:

```
multipaths {
 multipath {
 wwid 3600508b4000156d700012000000b0000
 alias yellow
 path_grouping_policy multibus
 path_selector "round-robin 0"
 failback manual
 }
}
```

```

 rr_weight priorities
 no_path_retry 5
 }
 multipath {
 wwid 1DEC_____321816758474
 alias red
 }
}

```

## Configuration file devices section

`multipath-tools` has a built-in device table with reasonable defaults for more than 100 known multipath-capable storage devices. The devices section can be used to override these settings. If there are multiple matches for a given device, the attributes of all matching entries are applied to it. If an attribute is specified in several matching device subsections, later entries take precedence.

The only recognised attribute for the devices section is the device subsection. Devices detected in the system are matched against the device entries using the vendor, product, and revision fields.

The vendor, product, and revision fields that `multipath` or `multipathd` detect for devices in a system depend on the device type. For SCSI devices, they correspond to the respective fields of the SCSI INQUIRY page. In general, the command `multipathd show paths format "%d %s"` command can be used to see the detected properties for all devices in the system.

The device subsection recognizes the following attributes:

1. `vendor`  
(Mandatory) Regular expression to match the vendor name.
2. `product`  
(Mandatory) Regular expression to match the product name.
3. `revision`  
Regular expression to match the product revision.
4. `product_blacklist`  
Products with the given vendor matching this string are blacklisted.
5. `alias_prefix`  
The *user\_friendly\_names* prefix to use for this device type, instead of the default *mpath*.
6. `hardware_handler`  
The hardware handler to use for this device type. The following hardware handler are implemented (all of these are hardware-dependent):
  - **1 emc** - Hardware handler for DGC class arrays as CLARiiON CX/AX and EMC VNX and Unity families.
  - **1 rdac** - Hardware handler for LSI / Engenio / NetApp RDAC class as NetApp SANtricity E/EF Series, and OEM arrays from IBM DELL SGI STK and SUN.
  - **1 hp\_sw** - Hardware handler for HP/COMPAQ/DEC HSG80 and MSA/HSV arrays with Active/Standby mode exclusively.
  - **1 alua** - Hardware handler for SCSI-3 ALUA-compatible arrays.
  - **1 ana** - Hardware handler for NVMe ANA-compatible arrays.

The following attributes are optional – if not set the default values are taken from the defaults section:

- `path_grouping_policy`
- `uid_attribute`
- `getuid_callout`
- `path_selector`
- `path_checker`
- `prio`
- `prio_args`
- `features`
- `failback`
- `rr_weight`
- `no_path_retry`
- `rr_min_io`
- `rr_min_io_rq`
- `fast_io_fail_tmo`

- dev\_loss\_tmo
- flush\_on\_last\_del
- user\_friendly\_names
- retain\_attached\_hw\_handler
- detect\_prio
- detect\_checker
- deferred\_remove
- san\_path\_err\_threshold
- san\_path\_err\_forget\_rate
- san\_path\_err\_recovery\_time
- marginal\_path\_err\_sample\_time
- marginal\_path\_err\_rate\_threshold
- marginal\_path\_err\_recheck\_gap\_time
- marginal\_path\_double\_failed\_time
- delay\_watch\_checks
- delay\_wait\_checks
- skip\_kpartx
- max\_sectors\_kb
- ghost\_delay
- all\_tg\_pt

Example:

```
devices {
 device {
 vendor "3PARdata"
 product "VV"
 path_grouping_policy "group_by_prio"
 hardware_handler "1 alua"
 prio "alua"
 failback "immediate"
 no_path_retry 18
 fast_io_fail_tmo 10
 dev_loss_tmo "infinity"
 }
 device {
 vendor "DEC"
 product "HSG80"
 path_grouping_policy "group_by_prio"
 path_checker "hp_sw"
 hardware_handler "1 hp_sw"
 prio "hp_sw"
 no_path_retry "queue"
 }
}
```

Before moving on with this session it is recommended that you read:

1. [Device mapper multipathing - introduction](#)
2. [Device mapper multipathing - configuration](#)

For consistency with those sections, we will refer here to device mapper multipathing as *multipath*.

This section provides step-by-step example procedures for setting up and configuring multipath. It includes the following procedures:

- Basic setup
  - Main *defaults* and *devices* attributes.
  - Shows how to *ignore disks* using blacklists
  - Shows how to *rename disks* using WWIDs
- Configuring active/active paths

## Basic setup

Before setting up multipath on your system, ensure that your system has been updated and includes the `multipath-tools` package. If boot from the storage area network (SAN) is desired, then the `multipath-tools-boot` package is also required.

A very simple `/etc/multipath.conf` file exists, as explained in [device mapper multipathing - configuration](#). All attributes not declared in `multipath.conf` are taken from the `multipath-tools` internal database and its internal blacklist.

The internal attributes database can be acquired by running the following on the command line:

```
sudo multipath -t
```

Multipath is usually able to work out-of-the-box with most common storages. This *does not* mean the default configuration variables should be used in production: they don't treat important parameters your storage might need.

With the *internal attributes*, described above, and the given example below, you will likely be able to create your `/etc/multipath.conf` file by squashing the code blocks below. Make sure to read the *defaults* section attribute comments and make any changes based on your environment needs.

- Example of a *defaults* section:

```
defaults {
 #
 # name : polling_interval
 # scope : multipathd
 # desc : interval between two path checks in seconds. For
 # properly functioning paths, the interval between checks
 # will gradually increase to (4 * polling_interval).
 # values : n > 0
 # default : 5
 #
 polling_interval 10

 #
 # name : path_selector
 # scope : multipath & multipathd
 # desc : the default path selector algorithm to use
 # these algorithms are offered by the kernel multipath target
 # values : "round-robin 0" = Loop through every path in the path group,
 # sending the same amount of I/O to each.
 # "queue-length 0" = Send the next bunch of I/O down the path
 # with the least amount of outstanding I/O.
 # "service-time 0" = Choose the path for the next bunch of I/O
 # based on the amount of outstanding I/O to
 # the path and its relative throughput.
 # default : "service-time 0"
 #
 path_selector "round-robin 0"

 #
 # name : path_grouping_policy
 # scope : multipath & multipathd
 # desc : the default path grouping policy to apply to unspecified
 # multipaths
 # values : failover = 1 path per priority group
 # multibus = all valid paths in 1 priority group
 # group_by_serial = 1 priority group per detected serial
 # number
 # group_by_prio = 1 priority group per path priority
 # value
 # group_by_node_name = 1 priority group per target node name
 # default : failover
 #
 path_grouping_policy multibus

 #
 # name : uid_attribute
 # scope : multipath & multipathd
 # desc : the default udev attribute from which the path
 # identifier should be generated.
 # default : ID_SERIAL
```

```

#
uid_attribute "ID_SERIAL"

#
name : getuid_callout
scope : multipath & multipathd
desc : the default program and args to callout to obtain a unique
path identifier. This parameter is deprecated.
This parameter is deprecated, superseded by uid_attribute
default : /lib/udev/scsi_id --whitelisted --device=/dev/%n
#
getuid_callout "/lib/udev/scsi_id --whitelisted --device=/dev/%n"

#
name : prio
scope : multipath & multipathd
desc : the default function to call to obtain a path
priority value. The ALUA bits in SPC-3 provide an
exploitable prio value for example.
default : const
#
prio "alua"

#
name : prio_args
scope : multipath & multipathd
desc : The arguments string passed to the prio function
Most prio functions do not need arguments. The
datacore prioritizer need one.
default : (null)
#
prio_args "timeout=1000 preferredsds=foo"

#
name : features
scope : multipath & multipathd
desc : The default extra features of multipath devices.
Syntax is "num[feature_0 feature_1 ...]", where `num' is the
number of features in the following (possibly empty) list of
features.
values : queue_if_no_path = Queue IO if no path is active; consider
using the `no_path_retry' keyword instead.
no_partitions = Disable automatic partitions generation via
kpartx.
default : "0"
#
features "0"
#features "1 queue_if_no_path"
#features "1 no_partitions"
#features "2 queue_if_no_path no_partitions"

#
name : path_checker, checker
scope : multipath & multipathd
desc : the default method used to determine the paths' state
values : readsector0|tur|emc_clariion|hp_sw|directio|rdac|cciss_tur
default : directio
#
path_checker directio

#
name : rr_min_io
scope : multipath & multipathd

```

```

desc : the number of IO to route to a path before switching
to the next in the same path group for the bio-based
multipath implementation. This parameter is used for
kernels version up to 2.6.31; newer kernel version
use the parameter rr_min_io_rq
default : 1000
#
rr_min_io 100

#
name : rr_min_io_rq
scope : multipath & multipathd
desc : the number of IO to route to a path before switching
to the next in the same path group for the request-based
multipath implementation. This parameter is used for
kernels versions later than 2.6.31.
default : 1
#
rr_min_io_rq 1

#
name : flush_on_last_del
scope : multipathd
desc : If set to "yes", multipathd will disable queueing when the
last path to a device has been deleted.
values : yes|no
default : no
#
flush_on_last_del yes

#
name : max_fds
scope : multipathd
desc : Sets the maximum number of open file descriptors for the
multipathd process.
values : max|n > 0
default : None
#
max_fds 8192

#
name : rr_weight
scope : multipath & multipathd
desc : if set to priorities the multipath configurator will assign
path weights as "path prio * rr_min_io"
values : priorities|uniform
default : uniform
#
rr_weight priorities

#
name : failback
scope : multipathd
desc : tell the daemon to manage path group failback, or not to.
0 means immediate failback, values >0 means deferred
failback expressed in seconds.
values : manual|immediate|n > 0
default : manual
#
failback immediate

#
name : no_path_retry

```

```

scope : multipath & multipathd
desc : tell the number of retries until disable queueing, or
"fail" means immediate failure (no queueing),
"queue" means never stop queueing
values : queue|fail|n (>0)
default : (null)
#
no_path_retry fail

#
name : queue_without_daemon
scope : multipathd
desc : If set to "no", multipathd will disable queueing for all
devices when it is shut down.
values : yes|no
default : yes
queue_without_daemon no

#
name : user_friendly_names
scope : multipath & multipathd
desc : If set to "yes", using the bindings file
/etc/multipath/bindings to assign a persistent and
unique alias to the multipath, in the form of mpath<n>.
If set to "no" use the WWID as the alias. In either case
this be will be overridden by any specific aliases in this
file.
values : yes|no
default : no
user_friendly_names yes

#
name : mode
scope : multipath & multipathd
desc : The mode to use for the multipath device nodes, in octal.
values : 0000 - 0777
default : determined by the process
mode 0644

#
name : uid
scope : multipath & multipathd
desc : The user id to use for the multipath device nodes. You
may use either the numeric or symbolic uid
values : <user_id>
default : determined by the process
uid 0

#
name : gid
scope : multipath & multipathd
desc : The group id to use for the multipath device nodes. You
may use either the numeric or symbolic gid
values : <group_id>
default : determined by the process
gid disk

#
name : checker_timeout
scope : multipath & multipathd
desc : The timeout to use for path checkers and prioritizers
that issue scsi commands with an explicit timeout, in
seconds.

```

```

values : n > 0
default : taken from /sys/block/sd<x>/device/timeout
checker_timeout 60

#
name : fast_io_fail_tmo
scope : multipath & multipathd
desc : The number of seconds the scsi layer will wait after a
problem has been detected on a FC remote port before failing
IO to devices on that remote port.
values : off | n >= 0 (smaller than dev_loss_tmo)
default : determined by the OS
fast_io_fail_tmo 5

#
name : dev_loss_tmo
scope : multipath & multipathd
desc : The number of seconds the scsi layer will wait after a
problem has been detected on a FC remote port before
removing it from the system.
values : infinity | n > 0
default : determined by the OS
dev_loss_tmo 120

#
name : bindings_file
scope : multipath
desc : The location of the bindings file that is used with
the user_friendly_names option.
values : <full_pathname>
default : "/var/lib/multipath/bindings"
bindings_file "/etc/multipath/bindings"

#
name : wwid_file
scope : multipath
desc : The location of the wwid file multipath uses to
keep track of the created multipath devices.
values : <full_pathname>
default : "/var/lib/multipath/wwid"
wwid_file "/etc/multipath/wwid"

#
name : reservation_key
scope : multipath
desc : Service action reservation key used by mpathpersist.
values : <key>
default : (null)
reservation_key "mpathkey"

#
name : force_sync
scope : multipathd
desc : If set to yes, multipath will run all of the checkers in
sync mode, even if the checker has an async mode.
values : yes|no
default : no
force_sync yes

#
name : config_dir
scope : multipath & multipathd
desc : If not set to an empty string, multipath will search

```



```

this directory alphabetically for files ending in ".conf"
and it will read configuration information from these
files, just as if it was in /etc/multipath.conf
values : "" or a fully qualified pathname
default : "/etc/multipath/conf.d"

#
name : delay_watch_checks
scope : multipathd
desc : If set to a value greater than 0, multipathd will watch
paths that have recently become valid for this many
checks. If they fail again while they are being watched,
when they next become valid, they will not be used until
they have stayed up for delay_wait_checks checks.
values : no|<n> > 0
default : no
delay_watch_checks 12

#
name : delay_wait_checks
scope : multipathd
desc : If set to a value greater than 0, when a device that has
recently come back online fails again within
delay_watch_checks checks, the next time it comes back
online, it will marked and delayed, and not used until
it has passed delay_wait_checks checks.
values : no|<n> > 0
default : no
delay_wait_checks 12
}

```

- Example of a *multipaths* section.

**Note:**

You can obtain the WWIDs for your LUNs by executing: `multipath -ll` after the service `multipath-tools.service` has been restarted.

```

multipaths {
 multipath {
 wwid 360000000000000000e0000000030001
 alias yellow
 }
 multipath {
 wwid 360000000000000000e0000000020001
 alias blue
 }
 multipath {
 wwid 360000000000000000e0000000010001
 alias red
 }
 multipath {
 wwid 360000000000000000e0000000040001
 alias green
 }
 multipath {
 wwid 360000000000000000e0000000050001
 alias purple
 }
}

```

- Small example of a *devices* section:

```

devices {
device {
vendor "IBM"

```

```
product "2107900"
path_grouping_policy group_by_serial
}
}
#
```

- Example of a *blacklist* section:

```
name : blacklist
scope : multipath & multipathd
desc : list of device names to discard as not multipath candidates
#
Devices can be identified by their device node name "devnode",
their WWID "wwid", or their vendor and product strings "device"
default : fd, hd, md, dm, sr, scd, st, ram, raw, loop, dcscblk
#
blacklist {
wwid 26353900f02796769
devnode "^(ram|raw|loop|fd|md|dm-|sr|scd|st)[0-9]*"
devnode "^hd[a-z]"
devnode "^dcscblk[0-9]*"
device {
vendor DEC.*
product MSA[15]00
}
}
```

- Example of a *blacklist exception* section:

```
name : blacklist_exceptions
scope : multipath & multipathd
desc : list of device names to be treated as multipath candidates
even if they are on the blacklist.
#
Note: blacklist exceptions are only valid in the same class.
It is not possible to blacklist devices using the devnode keyword
and to exclude some devices of them using the wwid keyword.
default : -
#
blacklist_exceptions {
devnode "^dasd[c-d]+[0-9]*"
wwid "IBM.75000000092461.4d00.34"
wwid "IBM.75000000092461.4d00.35"
wwid "IBM.75000000092461.4d00.36"
}
```

Before moving on with this session it is recommended that you read:

1. [Device mapper multipathing - introduction](#)
2. [Device mapper multipathing - configuration](#)
3. [Device mapper multipathing - setup](#)

For consistency with those sections, we will refer here to device mapper multipathing as *multipath*.

This section provides step-by-step example procedures for configuring multipath, and includes the following procedures:

- *Resizing* online multipath devices
- Moving root file system from a *single path* device to a *multipath* device
- The *multipathd* daemon
- Issues with *queue\_if\_no\_path*
- Multipath *command output*
- Multipath *queries* with *multipath* command
- Determining *device mapper entries* with *dmsetup* command
- Troubleshooting with the *multipathd* interactive console

## Resizing online multipath devices

First find all the paths to the logical unit number (LUN) about to be resized by running the following command:

```
$ sudo multipath -ll
```

```
mpathb (360014056eee8ec6e1164fcb959086482) dm-0 LI0-ORG,lun01
size=1.0G features='0' hwhandler='1 alua' wp=rw
|+- policy='service-time 0' prio=50 status=active
|`- 7:0:0:1 sde 8:64 active ready running
`+- policy='service-time 0' prio=50 status=enabled
 `- 8:0:0:1 sdf 8:80 active ready running
mpatha (36001405e3c2841430ee4bf3871b1998b) dm-1 LI0-ORG,lun02
size=1.0G features='0' hwhandler='1 alua' wp=rw
|+- policy='service-time 0' prio=50 status=active
|`- 7:0:0:2 sdc 8:32 active ready running
`+- policy='service-time 0' prio=50 status=enabled
 `- 8:0:0:2 sdd 8:48 active ready running
```

Now let's reconfigure mpathb (with wwid = 360014056eee8ec6e1164fcb959086482) to have 2GB instead of just 1Gb and check if it has changed:

```
$ echo 1 | sudo tee /sys/block/sde/device/rescan
```

```
1
```

```
$ echo 1 | sudo tee /sys/block/sdf/device/rescan
```

```
1
```

```
$ sudo multipath -ll
```

```
mpathb (360014056eee8ec6e1164fcb959086482) dm-0 LI0-ORG,lun01
size=1.0G features='0' hwhandler='1 alua' wp=rw
|+- policy='service-time 0' prio=50 status=active
|`- 7:0:0:1 sde 8:64 active ready running
`+- policy='service-time 0' prio=50 status=enabled
 `- 8:0:0:1 sdf 8:80 active ready running
mpatha (36001405e3c2841430ee4bf3871b1998b) dm-1 LI0-ORG,lun02
size=1.0G features='0' hwhandler='1 alua' wp=rw
|+- policy='service-time 0' prio=50 status=active
|`- 7:0:0:2 sdc 8:32 active ready running
`+- policy='service-time 0' prio=50 status=enabled
 `- 8:0:0:2 sdd 8:48 active ready running
```

Not yet! We still need to re-scan the multipath map:

```
$ sudo multipathd resize map mpathb
```

```
ok
```

And then we are good:

```
$ sudo multipath -ll
```

```
mpathb (360014056eee8ec6e1164fcb959086482) dm-0 LI0-ORG,lun01
size=2.0G features='0' hwhandler='1 alua' wp=rw
|+- policy='service-time 0' prio=50 status=active
|`- 7:0:0:1 sde 8:64 active ready running
.`+- policy='service-time 0' prio=50 status=enabled
 `- 8:0:0:1 sdf 8:80 active ready running
mpatha (36001405e3c2841430ee4bf3871b1998b) dm-1 LI0-ORG,lun02
size=1.0G features='0' hwhandler='1 alua' wp=rw
|+- policy='service-time 0' prio=50 status=active
|`- 7:0:0:2 sdc 8:32 active ready running
`+- policy='service-time 0' prio=50 status=enabled
 `- 8:0:0:2 sdd 8:48 active ready running
```

Make sure to run `resize2fs /dev/mapper/mpathb` to resize the filesystem.

## Moving root file system from a single path device to a multipath device

This is dramatically simplified by the use of UUIDs to identify devices as an intrinsic label. Simply install `multipath-tools-boot` and reboot. This will rebuild the initial RAM disk and afford multipath the opportunity to build its paths before the root filesystem is mounted by UUID.

### Note:

Whenever `multipath.conf` is updated, so should the `initrd` by executing:

```
update-initramfs -u -k all
```

The reason for this is `multipath.conf` is copied to the RAM disk and is integral to determining the available devices to map via its `denylist` and `devices` sections.

## The multipathd daemon

If you have trouble implementing a multipath configuration, you should ensure the multipath daemon is running as described in [device mapper multipathing - setup](#). The `multipathd` daemon must be running in order to use multipath devices.

## Multipath command output

When you create, modify, or list a multipath device, you get a printout of the current device setup. The format is as follows for each multipath device:

```
action_if_any: alias (wwid_if_different_from_alias) dm_device_name_if_known vendor,product
 size=size features='features' hwhandler='hardware_handler' wp=write_permission_if_known
```

For each path group:

```
-+- policy='scheduling_policy' prio=prio_if_known
 status=path_group_status_if_known
```

For each path:

```
`- host:channel:id:lun devnode major:minor dm_status_if_known path_status
 online_status
```

For example, the output of a multipath command might appear as follows:

```
mpathb (360014056eee8ec6e1164fcb959086482) dm-0 LIO-ORG,lun01
size=2.0G features='0' hwhandler='1 alua' wp=rw
|+- policy='service-time 0' prio=50 status=active
| ` 7:0:0:1 sde 8:64 active ready running
`+- policy='service-time 0' prio=50 status=enabled
 ` 8:0:0:1 sdf 8:80 active ready running
```

If the path is up and ready for I/O, the status of the path is *ready* or *ghost*. If the path is down, the status is *faulty* or *shaky*. The path status is updated periodically by the `multipathd` daemon based on the *polling interval* defined in the `/etc/multipath.conf` file.

The `dm_status` is similar to the path status, but from the kernel's point of view. The `dm_status` has two states: *failed*, which is analogous to *faulty*, and *active*, which covers all other path states. Occasionally, the *path* state and the *dm* state of a device will temporarily not agree.

The possible values for `online_status` are *running* and *offline*. A status of *offline* means that the SCSI device has been disabled.

## Multipath queries with multipath command

You can use the `-l` and `-ll` options of the `multipath` command to display the current multipath configuration.

- `-l`  
Displays multipath topology gathered from information in `sysfs` and the device mapper.
- `-ll`  
Displays the information the `-l` displays in addition to all other available components of the system.

When displaying the multipath configuration, there are three verbosity levels you can specify with the `-v` option of the `multipath` command. Specifying `-v0` yields *no output*. Specifying `-v1` outputs the *created or updated multipath names only*, which you can then feed to other tools such as `kpartx`. Specifying `-v2` prints *all detected paths, multipaths, and device maps*.

### Note:

The default *verbosity* level of multipath is 2 and can be globally modified by defining the *verbosity* attribute in the *defaults* section of *multipath.conf*.

The following example shows the output of a `sudo multipath -l` command:

```
mpathb (360014056eee8ec6e1164fcb959086482) dm-0 LI0-ORG,lun01
size=2.0G features='0' hwhandler='1 alua' wp=rw
|+- policy='service-time 0' prio=0 status=active
|`- 7:0:0:1 sde 8:64 active undef running
`+- policy='service-time 0' prio=0 status=enabled
 `- 8:0:0:1 sdf 8:80 active undef running
mpatha (36001405e3c2841430ee4bf3871b1998b) dm-1 LI0-ORG,lun02
size=1.0G features='0' hwhandler='1 alua' wp=rw
|+- policy='service-time 0' prio=0 status=active
|`- 7:0:0:2 sdc 8:32 active undef running
`+- policy='service-time 0' prio=0 status=enabled
 `- 8:0:0:2 sdd 8:48 active undef running
```

## Determining device mapper entries with `dmsetup` command

You can use the `dmsetup` command to find out which device mapper entries match the *multipathed* devices. The following command displays all the device mapper devices and their major and minor numbers. The minor numbers determine the name of the *dm* device. For example, a minor number of 1 corresponds to the `multipathd` device `/dev/dm-1`.

```
$ sudo dmsetup ls
mpathb (253:0)
mpatha (253:1)

$ ls -lahd /dev/dm*
brw-rw---- 1 root disk 253, 0 Apr 27 14:49 /dev/dm-0
brw-rw---- 1 root disk 253, 1 Apr 27 14:47 /dev/dm-1
```

## Troubleshooting with the `multipathd` interactive console

The `multipathd -k` command is an interactive interface to the `multipathd` daemon. Entering this command brings up an interactive multipath console. After entering this command, you can enter `help` to get a list of available commands, you can enter an interactive command, or you can enter `Ctrl+D` to quit.

The `multipathd` interactive console can be used to troubleshoot problems with your system. For example, the following command sequence displays the multipath configuration, including the defaults, before exiting the console.

```
$ sudo multipathd -k
> show config
> CTRL-D
```

The following command sequence ensures that multipath has picked up any changes to the `multipath.conf`:

```
$ sudo multipathd -k
> reconfigure
> CTRL-D
```

Use the following command sequence to ensure that the path checker is working properly:

```
$ sudo multipathd -k
> show paths
> CTRL-D
```

Commands can also be streamed into `multipathd` using STDIN like so:

```
$ echo 'show config' | sudo multipathd -k
```

Security should always be considered when installing, deploying, and using any type of computer system. Although a fresh installation of Ubuntu is relatively safe for immediate use on the Internet, it is important to have a balanced understanding of your system's security posture based on how it will be used after deployment.

This chapter provides an overview of security-related topics as they pertain to Ubuntu Server Edition, and outlines simple measures you may use to protect your server and network from any number of potential security threats.

If instead of security related administration and concepts for Ubuntu Server please be aware that there is more. Depending on what you were looking for please consider those references:

- Further information about security at Ubuntu, have a look at [Ubuntu Security](#)
- Information about known vulnerabilities:
  - per CVE check out the [CVE overview](#)
  - per Package have a look at the [Ubuntu Security Notices](#)
- Reporting a security issue, have a look at the [disclosure policy](#)

User management is a critical part of maintaining a secure system. Ineffective user and privilege management often lead many systems into being compromised. Therefore, it is important that you understand how you can protect your server through simple and effective user account management techniques.

## Where is root?

Ubuntu developers made a conscientious decision to disable the administrative root account by default in all Ubuntu installations. This does not mean that the root account has been deleted or that it may not be accessed. It merely has been given a password hash which matches no possible value, therefore may not log in directly by itself.

Instead, users are encouraged to make use of a tool by the name of ‘sudo’ to carry out system administrative duties. Sudo allows an authorized user to temporarily elevate their privileges using their own password instead of having to know the password belonging to the root account. This simple yet effective methodology provides accountability for all user actions, and gives the administrator granular control over which actions a user can perform with said privileges.

- If for some reason you wish to enable the root account, simply give it a password:

```
sudo passwd
```

Sudo will prompt you for your password, and then ask you to supply a new password for root as shown below:

```
[sudo] password for username: (enter your own password)
Enter new UNIX password: (enter a new password for root)
Retype new UNIX password: (repeat new password for root)
passwd: password updated successfully
```

- To disable the root account password, use the following passwd syntax:

```
sudo passwd -l root
```

- You should read more on Sudo by reading the man page:

```
man sudo
```

By default, the initial user created by the Ubuntu installer is a member of the group `sudo` which is added to the file `/etc/sudoers` as an authorized sudo user. If you wish to give any other account full root access through sudo, simply add them to the `sudo` group.

## Adding and Deleting Users

The process for managing local users and groups is straightforward and differs very little from most other GNU/Linux operating systems. Ubuntu and other Debian based distributions encourage the use of the ‘adduser’ package for account management.

- To add a user account, use the following syntax, and follow the prompts to give the account a password and identifiable characteristics, such as a full name, phone number, etc.

```
sudo adduser username
```

- To delete a user account and its primary group, use the following syntax:

```
sudo deluser username
```

Deleting an account does not remove their respective home folder. It is up to you whether or not you wish to delete the folder manually or keep it according to your desired retention policies.

Remember, any user added later on with the same UID/GID as the previous owner will now have access to this folder if you have not taken the necessary precautions.

You may want to change these UID/GID values to something more appropriate, such as the root account, and perhaps even relocate the folder to avoid future conflicts:

```
sudo chown -R root:root /home/username/
sudo mkdir /home/archived_users/
sudo mv /home/username /home/archived_users/
```

- To temporarily lock or unlock a user password, use the following syntax, respectively:

```
sudo passwd -l username
sudo passwd -u username
```

- To add or delete a personalized group, use the following syntax, respectively:

```
sudo addgroup groupname
sudo delgroup groupname
```

- To add a user to a group, use the following syntax:

```
sudo adduser username groupname
```

## User Profile Security

When a new user is created, the `adduser` utility creates a brand new home directory named `/home/username`. The default profile is modeled after the contents found in the directory of `/etc/skel`, which includes all profile basics.

If your server will be home to multiple users, you should pay close attention to the user home directory permissions to ensure confidentiality. By default, user home directories in Ubuntu are created with world read/execute permissions. This means that all users can browse and access the contents of other users home directories. This may not be suitable for your environment.

- To verify your current user home directory permissions, use the following syntax:

```
ls -ld /home/username
```

The following output shows that the directory `/home/username` has world-readable permissions:

```
drwxr-xr-x 2 username username 4096 2007-10-02 20:03 username
```

- You can remove the world readable-permissions using the following syntax:

```
sudo chmod 0750 /home/username
```

### Note

Some people tend to use the recursive option (`-R`) indiscriminately which modifies all child folders and files, but this is not necessary, and may yield other undesirable results. The parent directory alone is sufficient for preventing unauthorized access to anything below the parent.

A much more efficient approach to the matter would be to modify the `adduser` global default permissions when creating user home folders. Simply edit the file `/etc/adduser.conf` and modify the `DIR_MODE` variable to something appropriate, so that all new home directories will receive the correct permissions.

```
DIR_MODE=0750
```

- After correcting the directory permissions using any of the previously mentioned techniques, verify the results using the following syntax:

```
ls -ld /home/username
```

The results below show that world-readable permissions have been removed:

```
drwxr-x--- 2 username username 4096 2007-10-02 20:03 username
```

## Password Policy

A strong password policy is one of the most important aspects of your security posture. Many successful security breaches involve simple brute force and dictionary attacks against weak passwords. If you intend to offer any form of remote access involving your local password system, make sure you adequately address minimum password complexity requirements, maximum password lifetimes, and frequent audits of your authentication systems.

### Minimum Password Length

By default, Ubuntu requires a minimum password length of 6 characters, as well as some basic entropy checks. These values are controlled in the file `/etc/pam.d/common-password`, which is outlined below.

```
password [success=1 default=ignore] pam_unix.so obscure sha512
```

If you would like to adjust the minimum length to 8 characters, change the appropriate variable to `min=8`. The modification is outlined below.

```
password [success=1 default=ignore] pam_unix.so obscure sha512 minlen=8
```

### Note

Basic password entropy checks and minimum length rules do not apply to the administrator using `sudo` level commands to setup a new user.

## Password Expiration

When creating user accounts, you should make it a policy to have a minimum and maximum password age forcing users to change their passwords when they expire.

- To easily view the current status of a user account, use the following syntax:

```
sudo chage -l username
```

The output below shows interesting facts about the user account, namely that there are no policies applied:

```
Last password change : Jan 20, 2015
Password expires : never
Password inactive : never
Account expires : never
Minimum number of days between password change : 0
Maximum number of days between password change : 99999
Number of days of warning before password expires : 7
```

- To set any of these values, simply use the following syntax, and follow the interactive prompts:

```
sudo chage username
```

The following is also an example of how you can manually change the explicit expiration date (-E) to 01/31/2015, minimum password age (-m) of 5 days, maximum password age (-M) of 90 days, inactivity period (-I) of 30 days after password expiration, and a warning time period (-W) of 14 days before password expiration:

```
sudo chage -E 01/31/2015 -m 5 -M 90 -I 30 -W 14 username
```

- To verify changes, use the same syntax as mentioned previously:

```
sudo chage -l username
```

The output below shows the new policies that have been established for the account:

```
Last password change : Jan 20, 2015
Password expires : Apr 19, 2015
Password inactive : May 19, 2015
Account expires : Jan 31, 2015
Minimum number of days between password change : 5
Maximum number of days between password change : 90
Number of days of warning before password expires : 14
```

## Other Security Considerations

Many applications use alternate authentication mechanisms that can be easily overlooked by even experienced system administrators. Therefore, it is important to understand and control how users authenticate and gain access to services and applications on your server.

### SSH Access by Disabled Users

Simply disabling/locking a user password will not prevent a user from logging into your server remotely if they have previously set up SSH public key authentication. They will still be able to gain shell access to the server, without the need for any password. Remember to check the users home directory for files that will allow for this type of authenticated SSH access, e.g. `/home/username/.ssh/authorized_keys`.

Remove or rename the directory `.ssh/` in the user's home folder to prevent further SSH authentication capabilities.

Be sure to check for any established SSH connections by the disabled user, as it is possible they may have existing inbound or outbound connections. Kill any that are found.

```
who | grep username (to get the pts/# terminal)
sudo pkill -f pts/#
```



Restrict SSH access to only user accounts that should have it. For example, you may create a group called “sshlogin” and add the group name as the value associated with the `AllowGroups` variable located in the file `/etc/ssh/sshd_config`.

```
AllowGroups sshlogin
```

Then add your permitted SSH users to the group “sshlogin”, and restart the SSH service.

```
sudo adduser username sshlogin
sudo systemctl restart sshd.service
```

## External User Database Authentication

Most enterprise networks require centralized authentication and access controls for all system resources. If you have configured your server to authenticate users against external databases, be sure to disable the user accounts both externally and locally. This way you ensure that local fallback authentication is not possible.

Among some of the popular uses for smart cards is the ability to control access to computer systems. To operate the owner must have the smart card and they must know the PIN to unlock the card. This provides a higher degree of security than single-factor authentication such as just using a password.

The following sections describe how to enable smart card authentication on Ubuntu. They apply to Ubuntu 18.04 and 20.04.

## Requirements

### Software

The following packages must be installed to obtain a smart card configuration on Ubuntu.

- **pcscd**: contains the drivers needed to communicate with the CCID smart card readers.
- **opensc-pkcs11**: contains the smart card drivers, such as PIV or CAC.
- **libpam-pkcs11**: contains the PAM module to allow X.509 certificate logins via smart cards.

To install:

```
$ sudo apt update
$ sudo apt install opensc-pkcs11 libpam-pkcs11 pcscd
```

### Hardware

Any PIV or CAC smart card with the corresponding reader should be sufficient. USB smart cards like Yubikey embed the reader, and work like regular PIV cards.

Each smart card is expected to contain an X.509 certificate and the corresponding private key to be used for authentication.

## PAM configuration

The `pam_pkcs11` module allows PAM supported systems to use X.509 certificates to authenticate logins. The module relies on a PKCS#11 library, such as `opensc-pkcs11` to access the smart card for the credentials it will need.

When enabled, the `pam_pkcs11` login process is as follows:

1. Enter login
2. Enter PIN
3. Validate the X.509 certificate
4. Map the certificate to a user
5. Verify the login and match

To enable that process we have to configure the `pam_pkcs11` module and add the relevant certificate authorities, add `pam_pkcs11` to PAM configuration and set the mapping of certificate names to logins.

### Configure the `pam_pkcs11` module

```
$ cd /etc/pam_pkcs11
$ sudo cp /usr/share/doc/libpam-pkcs11/examples/pam_pkcs11.conf.example pkcs11.conf
```

Check the module, `cert_policy`, and `use_pkcs11_module` options defined within the `pkcs11_module opensc {}` entry in the `pam_pkcs11.conf` file. The module option should contain the absolute path of the `open-pkcs11.so` on the system. The `cert_policy` option should include `oscp` as one of its certificate verification policies.

In particular it should contain the following lines in Ubuntu 20.04.

```
use_pkcs11_module = openssl;
module = /usr/lib/x86_64-linux-gnu/openssl-pkcs11.so;
cert_policy = ca,signature,oscp_on;
```

Leave `debug = true` until everything is setup and is operating as desired.

## Map certificate names to login

This PAM module allows certificates to be used for login, though our Linux system needs to know the username. The `pam_pkcs11` module provides a variety of cert mappers to do this. Each cert mapper uses specific information from the certificate to map to a user on the system. The different cert mappers may even be stacked. In other words, if the first defined mapper fails to map to a user on the system, the next one will be tried, and so on until a user is found.

For the purposes of this guide, we will use the `pwent` mapper. This mapper uses the `getpwent()` system call to examine the `pw_name` and `pw_gecos` fields of every user for a match to the CN name. If either matches, the `pw_name` is returned as the login name. Next, it matches this result to the PAM login name to determine if a match was found or not. Set `pwent` as the mapper in the `pam_pkcs11.conf` file by modifying the existing entry:

```
use_mappers = pwent;
```

## Set the Certificate Authority and CRLs

To validate the smart card certificates the `pam_pkcs11` module needs to know the acceptable Certificate Authorities for signing user certificates and any available CRLs. You can add these in the following paths.

- **Certificate Authorities:** `/etc/pam_pkcs11/cacerts`
- **CRLs:** `/etc/pam_pkcs11/crls`

Assuming the Certificate Authority is in `ca.crt`, the following example sets it up.

```
$ sudo mkdir -p /etc/pam_pkcs11/cacerts
$ sudo cp ca.crt /etc/pam_pkcs11/cacerts
$ cd /etc/pam_pkcs11/cacerts
$ sudo pkcs11_make_hash_link
```

Similarly for the CRLs.

## Add pam\_pkcs11 to PAM

The next step includes the `pam_pkcs11` module into the PAM stack. There are various ways to do this depending on your local policy. The following example enables smart card support for general authentication.

Edit `/etc/pam.d/common-auth` to include the `pam_pkcs11` module as follows.

```
require pkcs11 smart card login
auth [success=2 default=ignore] pam_pkcs11.so
```

The above configuration will require the system to perform a smart card authentication only. If a user fails to authenticate with a smart card, then the login will fail. All the PAM services in the `/etc/pam.d` directory that include `common-auth` will require the smart card authentication.

---

**Warning:** A global configuration such as this requires a smart card for `su` and `sudo` authentication as well!

---

## Configure the pwent mapper

Now that `pam_pkcs11` and PAM have been configured for certificate logins, there is one more action. The `pwent` mapper requires the CN in the certificate to be in the `/etc/passwd` `gecos` field of the user. The CN must be extracted from the certificate on the smart card and added in `passwd`.

```
$ sudo apt install gnutls-bin
$ p11tool --list-tokens
```

The command above will show all the available smart cards in the system and its associated PKCS#11 URI. Copy the URI of selected card in the following command.

This command will print all certificates that can be used for authentication and their associated PKCS#11 URI.

```
$ p11tool --login --list-certs [TOKEN-URI]
```

Now, once the URI of the certificate that will be used for authentication is known, let's extract the Common Name from the certificate. In the example we are assuming that our certificate URI is `pkcs11:id=04`.

```
$ p11tool --login --export 'pkcs11:id=04' | openssl x509 -noout -subject
subject=CN = PIVKey BA366DFE3722C7449EC906B9274C8BAC
```

The CN is 'PIVKey BA366DFE3722C7449EC906B9274C8BAC'.

Edit the `/etc/passwd` file and add this CN to the `gecos` field of the user the certificate belongs to.

```
$ sudo usermod -c "PIVKey BA366DFE3722C7449EC906B9274C8BAC" foo
```

The OS is now ready to do a smart card login for the user `foo`.

## SSH authentication

See [this page on SSH authentication with smart cards](#).

One of the authentication methods supported by the SSH protocol is public key authentication. A public key is copied to the SSH server where it is stored and marked as authorized. The owner of the corresponding private key in the smart card can then SSH login to the server.

We will use `opensc-pkcs11` on the client to access the smart card drivers, and we will copy the public key from the smart card to the SSH server to make the authentication work.

The following instructions apply to Ubuntu 18.04 later.

## Server configuration

The SSH server and client must be configured to permit smart card authentication.

### Configure the SSH server

The SSH server needs to allow public key authentication set in its configuration file and it needs the user's public key.

Ensure the server has the `PubkeyAuthentication` option set to 'yes' in its `/etc/ssh/sshd_config` file. In a default `/etc/ssh/sshd_config` in Ubuntu, the `PubkeyAuthentication` option is commented out. However, the default is 'yes'. To ensure the setting, edit the `sshd_config` file and set accordingly.

```
PubkeyAuthentication yes
```

### Restart the SSH server

```
sudo systemctl restart sshd
```

### Set the public key on the server

Extract the user's public key from the smart card on the SSH client. Use `sshkeygen` to read the public key from the smart card and into a format consumable for SSH.

```
ssh-keygen -D /usr/lib/x86_64-linux-gnu/opensc-pkcs11.so > smartcard.pub
```

Copy this key to the SSH server.

```
ssh-copy-id -f -i smartcard.pub ubuntu@server-2
/usr/bin/ssh-copy-id: INFO: Source of key(s) to be installed: "smartcard.pub"
ubuntu@server-2's password:
Number of key(s) added: 1
Now try logging into the machine, with: "ssh 'ubuntu@server-2'"
and check to make sure that only the key(s) you wanted were added.
```

## Client configuration

The SSH client needs to identify its PKCS#11 provider. To do that set the `PKCS11Provider` option in the `~/.ssh/config` file of each user desiring to use SSH smart card login.

```
PKCS11Provider /usr/lib/x86_64-linux-gnu/opensc-pkcs11.so
```

Use this method to enforce SSH smart card login on a per user basis.

After this step you can SSH into the server using the smart card for authentication.

AppArmor is a Linux Security Module implementation of name-based mandatory access controls. AppArmor confines individual programs to a set of listed files and posix 1003.1e draft capabilities.

AppArmor is installed and loaded by default. It uses *profiles* of an application to determine what files and permissions the application requires. Some packages will install their own profiles, and additional profiles can be found in the `apparmor-profiles` package.

To install the `apparmor-profiles` package from a terminal prompt:

```
sudo apt install apparmor-profiles
```

AppArmor profiles have two modes of execution:

- **Complaining/Learning:** profile violations are permitted and logged. Useful for testing and developing new profiles.
- **Enforced/Confined:** enforces profile policy as well as logging the violation.

## Using AppArmor

The optional `apparmor-utils` package contains command line utilities that you can use to change the AppArmor execution mode, find the status of a profile, create new profiles, etc.

- `apparmor_status` is used to view the current status of AppArmor profiles.

```
sudo apparmor_status
```

- `aa-complain` places a profile into *complain* mode.

```
sudo aa-complain /path/to/bin
```

- `aa-enforce` places a profile into *enforce* mode.

```
sudo aa-enforce /path/to/bin
```

- The `/etc/apparmor.d` directory is where the AppArmor profiles are located. It can be used to manipulate the *mode* of all profiles.

Enter the following to place all profiles into complain mode:

```
sudo aa-complain /etc/apparmor.d/*
```

To place all profiles in enforce mode:

```
sudo aa-enforce /etc/apparmor.d/*
```

- `apparmor_parser` is used to load a profile into the kernel. It can also be used to reload a currently loaded profile using the `-r` option after modifying it to have the changes take effect.

To reload a profile:

```
sudo apparmor_parser -r /etc/apparmor.d/profile.name
```

- `systemctl` can be used to *reload* all profiles:

```
sudo systemctl reload apparmor.service
```

- The `/etc/apparmor.d/disable` directory can be used along with the `apparmor_parser -R` option to *disable* a profile.

```
sudo ln -s /etc/apparmor.d/profile.name /etc/apparmor.d/disable/
```

```
sudo apparmor_parser -R /etc/apparmor.d/profile.name
```

To *re-enable* a disabled profile remove the symbolic link to the profile in `/etc/apparmor.d/disable/`. Then load the profile using the `-a` option.

```
sudo rm /etc/apparmor.d/disable/profile.name
```

```
cat /etc/apparmor.d/profile.name | sudo apparmor_parser -a
```

- AppArmor can be disabled, and the kernel module unloaded by entering the following:

```
sudo systemctl stop apparmor.service
```

```
sudo systemctl disable apparmor.service
```

- To re-enable AppArmor enter:

```
sudo systemctl enable apparmor.service
sudo systemctl start apparmor.service
```

### Note

Replace *profile.name* with the name of the profile you want to manipulate. Also, replace */path/to/bin/* with the actual executable file path. For example for the ping command use */bin/ping*

## Profiles

AppArmor profiles are simple text files located in */etc/apparmor.d/*. The files are named after the full path to the executable they profile replacing the “/” with “.”. For example */etc/apparmor.d/bin.ping* is the AppArmor profile for the */bin/ping* command.

There are two main type of rules used in profiles:

- *Path entries*: detail which files an application can access in the file system.
- *Capability entries*: determine what privileges a confined process is allowed to use.

As an example, take a look at */etc/apparmor.d/bin.ping*:

```
#include <tunables/global>
/bin/ping flags=(complain) {
 #include <abstractions/base>
 #include <abstractions/consoles>
 #include <abstractions/nameservice>

 capability net_raw,
 capability setuid,
 network inet raw,

 /bin/ping mixr,
 /etc/modules.conf r,
}
```

- *#include <tunables/global>*: include statements from other files. This allows statements pertaining to multiple applications to be placed in a common file.
- */bin/ping flags=(complain)*: path to the profiled program, also setting the mode to *complain*.
- *capability net\_raw*,: allows the application access to the CAP\_NET\_RAW Posix.1e capability.
- */bin/ping mixr*,: allows the application read and execute access to the file.

### Note

After editing a profile file the profile must be reloaded. See above at [Using AppArmor](#) for details.

## Creating a Profile

- *Design a test plan*: Try to think about how the application should be exercised. The test plan should be divided into small test cases. Each test case should have a small description and list the steps to follow.

Some standard test cases are:

- Starting the program.
- Stopping the program.
- Reloading the program.
- Testing all the commands supported by the init script.

- *Generate the new profile*: Use *aa-genprof* to generate a new profile. From a terminal:

```
sudo aa-genprof executable
```

For example:

```
sudo aa-genprof slapd
```

- To get your new profile included in the *apparmor-profiles* package, file a bug in *Launchpad* against the [AppArmor](#) package:

- Include your test plan and test cases.
- Attach your new profile to the bug.

## Updating Profiles

When the program is misbehaving, audit messages are sent to the log files. The program `aa-logprof` can be used to scan log files for AppArmor audit messages, review them and update the profiles. From a terminal:

```
sudo aa-logprof
```

## Further pre-existing Profiles

The packages `appport-profiles` and `apparmor-profiles-extra` ship some experimental profiles for AppArmor security policies.

Do not expect these profiles to work out-of-the-box, but they can give you a head start when trying to create a new profile by starting off a base that exists.

These profiles are not considered mature enough to be shipped in enforce mode by default. Therefore they are shipped in complain mode so that users can test them, choose which are desired, and help improve them upstream if needed.

Some even more experimental profiles carried by the package are placed in `/usr/share/doc/apparmor-profiles/extras/`

## Checking and debugging denies

You will see in ‘`dmesg`’ and any log that collects kernel messages if you have hit a deny.

Right away it is worth to know that this will cover any access that was denied because it was not allowed, but explicit denies will put no message in your logs at all.

Examples might look like:

```
[1521056.552037] audit: type=1400 audit(1571868402.378:24425): apparmor="DENIED" operation="open" profile="/usr/sbin/cups-browsed" name="/var/lib/libvirt/dnsmasq/" pid=1128 comm="cups-browsed" requested_mask="r" denied_mask="r" fsuid=0 ouid=0
[1482106.651527] audit: type=1400 audit(1571829452.330:24323): apparmor="DENIED" operation="sendmsg" profile="snap.lxd."
```

That follows a generic structure starting with a timestamp, an audit tag and the category `apparmor="DENIED"`.

From the following fields you can derive what was going on and why it was failing.

In the examples above that would be

First example:

- operation: `open` (program tried to open a file)
- profile: `/usr/sbin/cups-browsed` (you’ll find `/etc/apparmor.d/usr.bin.cups-browsed`)
- name: `/var/lib/libvirt/dnsmasq` (what it wanted to access)
- pid/comm: the program that did trigger the access
- requested\_mask/denied\_mask/fsuid/ouid: parameters of that open call

Second example:

- operation: `sendmsg` (program tried send via network)
- profile: `snap.lxd.lxc` (snaps are special, you’ll find `/var/lib/snappd/apparmor/profiles/snap.lxd.lxc`)
- pid/comm: the program that did trigger the access
- laddr/lport/faddr/fport/family/socket\_type/protocol: parameters of that sendmsg call

That way you know in which profile and at what action you have to start if you consider either debugging or adapting the profiles.

## Profile customization

Profiles are meant to provide security and thereby can’t be all too open. But quite often a very special setup would work with a profile if it would *just allow this one extra access*. To handle that there are three ways.

- modify the profile itself
  - always works, but has the drawback that profiles are in `/etc` and considered conffiles. So after modification on a related package update you might get a conffile prompt. Worst case depending on configuration automatic updates might even override it and your custom rule is gone.
- use tunables
  - those provide variables that can be used in templates, for example if you want a custom dir considered as it would be a home directory you could modify `/etc/apparmor.d/tunables/home` which defines the base path rules use for home directories

- by design those variables will only influence profiles that use them
- modify a local override
  - to mitigate the drawbacks of above approaches *local includes* got introduced adding the ability to write arbitrary rules that will be used, and not get issues on upgrades that modify the packaged rule.
  - The files can be found in `/etc/apparmor.d/local/` and exist for the packages that are known to sometimes need slight tweaks for special setups

## References

- See the [AppArmor Administration Guide](#) for advanced configuration options.
- For details using AppArmor with other Ubuntu releases see the [AppArmor Community Wiki](#) page.
- The [OpenSUSE AppArmor](#) page is another introduction to AppArmor.
- (<https://wiki.debian.org/AppArmor>) is another introduction and basic howto for AppArmor.
- A great place to get involved with the Ubuntu Server community and to ask for AppArmor assistance is the `#ubuntu-server` IRC channel on [Libera](#). The `#ubuntu-security` IRC channel may also be of use.

## Introduction

The Linux kernel includes the *Netfilter* subsystem, which is used to manipulate or decide the fate of network traffic headed into or through your server. All modern Linux firewall solutions use this system for packet filtering.

The kernel’s packet filtering system would be of little use to administrators without a userspace interface to manage it. This is the purpose of iptables: When a packet reaches your server, it will be handed off to the Netfilter subsystem for acceptance, manipulation, or rejection based on the rules supplied to it from userspace via iptables. Thus, iptables is all you need to manage your firewall, if you’re familiar with it, but many frontends are available to simplify the task.

## ufw - Uncomplicated Firewall

The default firewall configuration tool for Ubuntu is ufw. Developed to ease iptables firewall configuration, ufw provides a user-friendly way to create an IPv4 or IPv6 host-based firewall.

ufw by default is initially disabled. From the ufw man page:

“ufw is not intended to provide complete firewall functionality via its command interface, but instead provides an easy way to add or remove simple rules. It is currently mainly used for host-based firewalls.”

The following are some examples of how to use ufw:

- First, ufw needs to be enabled. From a terminal prompt enter:

```
sudo ufw enable
```

- To open a port (SSH in this example):

```
sudo ufw allow 22
```

- Rules can also be added using a *numbered* format:

```
sudo ufw insert 1 allow 80
```

- Similarly, to close an opened port:

```
sudo ufw deny 22
```

- To remove a rule, use delete followed by the rule:

```
sudo ufw delete deny 22
```

- It is also possible to allow access from specific hosts or networks to a port. The following example allows SSH access from host 192.168.0.2 to any IP address on this host:

```
sudo ufw allow proto tcp from 192.168.0.2 to any port 22
```

Replace 192.168.0.2 with 192.168.0.0/24 to allow SSH access from the entire subnet.

- Adding the `--dry-run` option to a *ufw* command will output the resulting rules, but not apply them. For example, the following is what would be applied if opening the HTTP port:

```
sudo ufw --dry-run allow http
```

```
*filter
```

```
:ufw-user-input - [0:0]
```

```
:ufw-user-output - [0:0]
```

```

:ufw-user-forward - [0:0]
:ufw-user-limit - [0:0]
:ufw-user-limit-accept - [0:0]
RULES

tuple ### allow tcp 80 0.0.0.0/0 any 0.0.0.0/0
-A ufw-user-input -p tcp --dport 80 -j ACCEPT

END RULES
-A ufw-user-input -j RETURN
-A ufw-user-output -j RETURN
-A ufw-user-forward -j RETURN
-A ufw-user-limit -m limit --limit 3/minute -j LOG --log-prefix "[UFW LIMIT]: "
-A ufw-user-limit -j REJECT
-A ufw-user-limit-accept -j ACCEPT
COMMIT
Rules updated

```

- ufw can be disabled by:

```
sudo ufw disable
```

- To see the firewall status, enter:

```
sudo ufw status
```

- And for more verbose status information use:

```
sudo ufw status verbose
```

- To view the *numbered* format:

```
sudo ufw status numbered
```

### Note

If the port you want to open or close is defined in `/etc/services`, you can use the port name instead of the number. In the above examples, replace `22` with `ssh`.

This is a quick introduction to using ufw. Please refer to the ufw man page for more information.

## ufw Application Integration

Applications that open ports can include an ufw profile, which details the ports needed for the application to function properly. The profiles are kept in `/etc/ufw/applications.d`, and can be edited if the default ports have been changed.

- To view which applications have installed a profile, enter the following in a terminal:

```
sudo ufw app list
```

- Similar to allowing traffic to a port, using an application profile is accomplished by entering:

```
sudo ufw allow Samba
```

- An extended syntax is available as well:

```
ufw allow from 192.168.0.0/24 to any app Samba
```

Replace *Samba* and *192.168.0.0/24* with the application profile you are using and the IP range for your network.

### Note

There is no need to specify the *protocol* for the application, because that information is detailed in the profile. Also, note that the *app* name replaces the *port* number.

- To view details about which ports, protocols, etc., are defined for an application, enter:

```
sudo ufw app info Samba
```

Not all applications that require opening a network port come with ufw profiles, but if you have profiled an application and want the file to be included with the package, please file a bug against the package in Launchpad.

```
ubuntu-bug nameofpackage
```



## IP Masquerading

The purpose of IP Masquerading is to allow machines with private, non-routable IP addresses on your network to access the Internet through the machine doing the masquerading. Traffic from your private network destined for the Internet must be manipulated for replies to be routable back to the machine that made the request. To do this, the kernel must modify the *source* IP address of each packet so that replies will be routed back to it, rather than to the private IP address that made the request, which is impossible over the Internet. Linux uses *Connection Tracking* (conntrack) to keep track of which connections belong to which machines and reroute each return packet accordingly. Traffic leaving your private network is thus “masqueraded” as having originated from your Ubuntu gateway machine. This process is referred to in Microsoft documentation as Internet Connection Sharing.

### ufw Masquerading

IP Masquerading can be achieved using custom ufw rules. This is possible because the current back-end for ufw is iptables-restore with the rules files located in `/etc/ufw/*.rules`. These files are a great place to add legacy iptables rules used without ufw, and rules that are more network gateway or bridge related.

The rules are split into two different files, rules that should be executed before ufw command line rules, and rules that are executed after ufw command line rules.

- First, packet forwarding needs to be enabled in ufw. Two configuration files will need to be adjusted, in `/etc/default/ufw` change the `DEFAULT_FORWARD_POLICY` to “ACCEPT”:

```
DEFAULT_FORWARD_POLICY="ACCEPT"
```

Then edit `/etc/ufw/sysctl.conf` and uncomment:

```
net/ipv4/ip_forward=1
```

Similarly, for IPv6 forwarding uncomment:

```
net/ipv6/conf/default/forwarding=1
```

- Now add rules to the `/etc/ufw/before.rules` file. The default rules only configure the *filter* table, and to enable masquerading the *nat* table will need to be configured. Add the following to the top of the file just after the header comments:

```
nat Table rules
```

```
*nat
```

```
:POSTROUTING ACCEPT [0:0]
```

```
Forward traffic from eth1 through eth0.
```

```
-A POSTROUTING -s 192.168.0.0/24 -o eth0 -j MASQUERADE
```

```
don't delete the 'COMMIT' line or these nat table rules won't be processed
```

```
COMMIT
```

The comments are not strictly necessary, but it is considered good practice to document your configuration. Also, when modifying any of the *rules* files in `/etc/ufw`, make sure these lines are the last line for each table modified:

```
don't delete the 'COMMIT' line or these rules won't be processed
```

```
COMMIT
```

For each *Table* a corresponding *COMMIT* statement is required. In these examples only the *nat* and *filter* tables are shown, but you can also add rules for the *raw* and *mangle* tables.

#### Note

In the above example replace *eth0*, *eth1*, and *192.168.0.0/24* with the appropriate interfaces and IP range for your network.

- Finally, disable and re-enable ufw to apply the changes:

```
sudo ufw disable && sudo ufw enable
```

IP Masquerading should now be enabled. You can also add any additional FORWARD rules to the `/etc/ufw/before.rules`. It is recommended that these additional rules be added to the *ufw-before-forward* chain.

### iptables Masquerading

iptables can also be used to enable Masquerading.

- Similar to ufw, the first step is to enable IPv4 packet forwarding by editing `/etc/sysctl.conf` and uncomment the following line:

```
net.ipv4.ip_forward=1
```

If you wish to enable IPv6 forwarding also uncomment:

```
net.ipv6.conf.default.forwarding=1
```

- Next, execute the `sysctl` command to enable the new settings in the configuration file:

```
sudo sysctl -p
```

- IP Masquerading can now be accomplished with a single iptables rule, which may differ slightly based on your network configuration:

```
sudo iptables -t nat -A POSTROUTING -s 192.168.0.0/16 -o ppp0 -j MASQUERADE
```

The above command assumes that your private address space is 192.168.0.0/16 and that your Internet-facing device is ppp0. The syntax is broken down as follows:

- `-t nat` – the rule is to go into the nat table
- `-A POSTROUTING` – the rule is to be appended (`-A`) to the POSTROUTING chain
- `-s 192.168.0.0/16` – the rule applies to traffic originating from the specified address space
- `-o ppp0` – the rule applies to traffic scheduled to be routed through the specified network device
- `-j MASQUERADE` – traffic matching this rule is to “jump” (`-j`) to the MASQUERADE target to be manipulated as described above

- Also, each chain in the filter table (the default table, and where most or all packet filtering occurs) has a default *policy* of ACCEPT, but if you are creating a firewall in addition to a gateway device, you may have set the policies to DROP or REJECT, in which case your masqueraded traffic needs to be allowed through the FORWARD chain for the above rule to work:

```
sudo iptables -A FORWARD -s 192.168.0.0/16 -o ppp0 -j ACCEPT
sudo iptables -A FORWARD -d 192.168.0.0/16 -m state \
--state ESTABLISHED,RELATED -i ppp0 -j ACCEPT
```

The above commands will allow all connections from your local network to the Internet and all traffic related to those connections to return to the machine that initiated them.

- If you want masquerading to be enabled on reboot, which you probably do, edit `/etc/rc.local` and add any commands used above. For example add the first command with no filtering:

```
iptables -t nat -A POSTROUTING -s 192.168.0.0/16 -o ppp0 -j MASQUERADE
```

## Logs

Firewall logs are essential for recognizing attacks, troubleshooting your firewall rules, and noticing unusual activity on your network. You must include logging rules in your firewall for them to be generated, though, and logging rules must come before any applicable terminating rule (a rule with a target that decides the fate of the packet, such as ACCEPT, DROP, or REJECT).

If you are using ufw, you can turn on logging by entering the following in a terminal:

```
sudo ufw logging on
```

To turn logging off in ufw, simply replace *on* with *off* in the above command.

If using iptables instead of ufw, enter:

```
sudo iptables -A INPUT -m state --state NEW -p tcp --dport 80 \
-j LOG --log-prefix "NEW_HTTP_CONN: "
```

A request on port 80 from the local machine, then, would generate a log in dmesg that looks like this (single line split into 3 to fit this document):

```
[4304885.870000] NEW_HTTP_CONN: IN=lo OUT= MAC=00:00:00:00:00:00:00:00:00:00:00:00:08:00
SRC=127.0.0.1 DST=127.0.0.1 LEN=60 TOS=0x00 PREC=0x00 TTL=64 ID=58288 DF PROTO=TCP
SPT=53981 DPT=80 WINDOW=32767 RES=0x00 SYN URGP=0
```

The above log will also appear in `/var/log/messages`, `/var/log/syslog`, and `/var/log/kern.log`. This behavior can be modified by editing `/etc/syslog.conf` appropriately or by installing and configuring `ulogd` and using the `ULOG` target instead of `LOG`. The `ulogd` daemon is a userspace server that listens for logging instructions from the kernel specifically for firewalls, and can log to any file you like, or even to a PostgreSQL or MySQL database. Making sense of your firewall logs can be simplified by using a log analyzing tool such as `logwatch`, `fwalog`, `fwlogwatch`, or `lire`.

## Other Tools

There are many tools available to help you construct a complete firewall without intimate knowledge of `iptables`. A command-line tool with plain-text configuration files:

- [Shorewall](#) is a very powerful solution to help you configure an advanced firewall for any network.

## References

- The [Ubuntu Firewall](#) wiki page contains information on the development of `ufw`.
- Also, the `ufw` manual page contains some very useful information: `man ufw`.
- See the [packet-filtering-HOWTO](#) for more information on using `iptables`.
- The [nat-HOWTO](#) contains further details on masquerading.
- The [IPTables HowTo](#) in the Ubuntu wiki is a great resource.

One of the most common forms of cryptography today is *public-key* cryptography. Public-key cryptography utilizes a *public key* and a *private key*. The system works by encrypting information using the public key. The information can then only be decrypted using the private key.

A common use for public-key cryptography is encrypting application traffic using a Secure Socket Layer (SSL) or Transport Layer Security (TLS) connection. One example: configuring Apache to provide *HTTPS*, the HTTP protocol over SSL/TLS. This allows a way to encrypt traffic using a protocol that does not itself provide encryption.

A *certificate* is a method used to distribute a *public key* and other information about a server and the organization who is responsible for it. Certificates can be digitally signed by a *Certification Authority*, or CA. A CA is a trusted third party that has confirmed that the information contained in the certificate is accurate.

## Types of Certificates

To set up a secure server using public-key cryptography, in most cases, you send your certificate request (including your public key), proof of your company's identity, and payment to a CA. The CA verifies the certificate request and your identity, and then sends back a certificate for your secure server. Alternatively, you can create your own *self-signed* certificate.

### Note

Note that self-signed certificates should not be used in most production environments.

Continuing the HTTPS example, a CA-signed certificate provides two important capabilities that a self-signed certificate does not:

- Browsers (usually) automatically recognize the CA signature and allow a secure connection to be made without prompting the user.
- When a CA issues a signed certificate, it is guaranteeing the identity of the organization that is providing the web pages to the browser.

Most of the software supporting SSL/TLS have a list of CAs whose certificates they automatically accept. If a browser encounters a certificate whose authorizing CA is not in the list, the browser asks the user to either accept or decline the connection. Also, other applications may generate an error message when using a self-signed certificate.

The process of getting a certificate from a CA is fairly easy. A quick overview is as follows:

1. Create a private and public encryption key pair.
2. Create a certificate signing request based on the public key. The certificate request contains information about your server and the company hosting it.
3. Send the certificate request, along with documents proving your identity, to a CA. We cannot tell you which certificate authority to choose. Your decision may be based on your past experiences, or on the experiences of your friends or colleagues, or purely on monetary factors.

Once you have decided upon a CA, you need to follow the instructions they provide on how to obtain a certificate from them.

4. When the CA is satisfied that you are indeed who you claim to be, they send you a digital certificate.
5. Install this certificate on your secure server, and configure the appropriate applications to use the certificate.

## Generating a Certificate Signing Request (CSR)

Whether you are getting a certificate from a CA or generating your own self-signed certificate, the first step is to generate a key.

If the certificate will be used by service daemons, such as Apache, Postfix, Dovecot, etc., a key without a passphrase is often appropriate. Not having a passphrase allows the services to start without manual intervention, usually the preferred way to start a daemon.

This section will cover generating a key with a passphrase, and one without. The non-passphrase key will then be used to generate a certificate that can be used with various service daemons.

### Warning

Running your secure service without a passphrase is convenient because you will not need to enter the passphrase every time you start your secure service. But it is insecure and a compromise of the key means a compromise of the server as well.

To generate the *keys* for the Certificate Signing Request (CSR) run the following command from a terminal prompt:

```
openssl genrsa -des3 -out server.key 2048
```

```
Generating RSA private key, 2048 bit long modulus
```

```
.....+++++
```

```
.....+++++
```

```
e is 65537 (0x10001)
```

```
Enter pass phrase for server.key:
```

You can now enter your passphrase. For best security, it should at least contain eight characters. The minimum length when specifying `-des3` is four characters. As a best practice it should include numbers and/or punctuation and not be a word in a dictionary. Also remember that your passphrase is case-sensitive.

Re-type the passphrase to verify. Once you have re-typed it correctly, the server key is generated and stored in the `server.key` file.

Now create the insecure key, the one without a passphrase, and shuffle the key names:

```
openssl rsa -in server.key -out server.key.insecure
```

```
mv server.key server.key.secure
```

```
mv server.key.insecure server.key
```

The insecure key is now named `server.key`, and you can use this file to generate the CSR without passphrase.

To create the CSR, run the following command at a terminal prompt:

```
openssl req -new -key server.key -out server.csr
```

It will prompt you enter the passphrase. If you enter the correct passphrase, it will prompt you to enter Company Name, Site Name, Email Id, etc. Once you enter all these details, your CSR will be created and it will be stored in the `server.csr` file.

You can now submit this CSR file to a CA for processing. The CA will use this CSR file and issue the certificate. On the other hand, you can create self-signed certificate using this CSR.

## Creating a Self-Signed Certificate

To create the self-signed certificate, run the following command at a terminal prompt:

```
openssl x509 -req -days 365 -in server.csr -signkey server.key -out server.crt
```

The above command will prompt you to enter the passphrase. Once you enter the correct passphrase, your certificate will be created and it will be stored in the `server.crt` file.

### Warning

If your secure server is to be used in a production environment, you probably need a CA-signed certificate. It is not recommended to use self-signed certificate.

## Installing the Certificate

You can install the key file `server.key` and certificate file `server.crt`, or the certificate file issued by your CA, by running following commands at a terminal prompt:

```
sudo cp server.crt /etc/ssl/certs
sudo cp server.key /etc/ssl/private
```

Now simply configure any applications, with the ability to use public-key cryptography, to use the *certificate* and *key* files. For example, Apache can provide HTTPS, Dovecot can provide IMAPS and POP3S, etc.

## Certification Authority

If the services on your network require more than a few self-signed certificates it may be worth the additional effort to setup your own internal Certification Authority (CA). Using certificates signed by your own CA, allows the various services using the certificates to easily trust other services using certificates issued from the same CA.

First, create the directories to hold the CA certificate and related files:

```
sudo mkdir /etc/ssl/CA
sudo mkdir /etc/ssl/newcerts
```

The CA needs a few additional files to operate, one to keep track of the last serial number used by the CA, each certificate must have a unique serial number, and another file to record which certificates have been issued:

```
sudo sh -c "echo '01' > /etc/ssl/CA/serial"
sudo touch /etc/ssl/CA/index.txt
```

The third file is a CA configuration file. Though not strictly necessary, it is very convenient when issuing multiple certificates. Edit `/etc/ssl/openssl.cnf`, and in the `[ CA_default ]` change:

```
dir = /etc/ssl # Where everything is kept
database = $dir/CA/index.txt # database index file.
certificate = $dir/certs/cacert.pem # The CA certificate
serial = $dir/CA/serial # The current serial number
private_key = $dir/private/cakey.pem# The private key
```

Next, create the self-signed root certificate:

```
openssl req -new -x509 -extensions v3_ca -keyout cakey.pem -out cacert.pem -days 3650
```

You will then be asked to enter the details about the certificate.

Now install the root certificate and key:

```
sudo mv cakey.pem /etc/ssl/private/
sudo mv cacert.pem /etc/ssl/certs/
```

You are now ready to start signing certificates. The first item needed is a Certificate Signing Request (CSR), see [Generating a Certificate Signing Request \(CSR\)](#) for details. Once you have a CSR, enter the following to generate a certificate signed by the CA:

```
sudo openssl ca -in server.csr -config /etc/ssl/openssl.cnf
```

After entering the password for the CA key, you will be prompted to sign the certificate, and again to commit the new certificate. You should then see a somewhat large amount of output related to the certificate creation.

There should now be a new file, `/etc/ssl/newcerts/01.pem`, containing the same output. Copy and paste everything beginning with the line: `-----BEGIN CERTIFICATE-----` and continuing through the line: `-----END CERTIFICATE-----` lines to a file named after the hostname of the server where the certificate will be installed. For example `mail.example.com.crt`, is a nice descriptive name.

Subsequent certificates will be named `02.pem`, `03.pem`, etc.

### Note

Replace `mail.example.com.crt` with your own descriptive name.

Finally, copy the new certificate to the host that needs it, and configure the appropriate applications to use it. The default location to install certificates is `/etc/ssl/certs`. This enables multiple services to use the same certificate without overly complicated file permissions.

For applications that can be configured to use a CA certificate, you should also copy the `/etc/ssl/certs/cacert.pem` file to the `/etc/ssl/certs/` directory on each server.

## References

- The Wikipedia [HTTPS](#) page has more information regarding HTTPS.
- For more information on *OpenSSL* see the [OpenSSL Home Page](#).
- Also, O'Reilly's [Network Security with OpenSSL](#) is a good in-depth reference.

Enterprise environments sometimes have a local Certificate Authority (CA) that issues certificates for use within the organization. For an Ubuntu server to be functional and trust the hosts in this environment this CA must be installed in Ubuntu's trust store.

## How to recognize the form (PEM or DER)?

To install a certificate in the trust store it must be in PEM form. A PEM-formatted certificate is human-readable in base64 format, and starts with the lines `-----BEGIN CERTIFICATE-----`. If you see these lines, you're ready to install. If not, it is most likely a DER certificate and needs to be converted.

## Installing a certificate in PEM form

Assuming a PEM-formatted root CA certificate is in `local-ca.crt`, follow the steps below to install it.

**Note:** It is important to have the `.crt` extension on the file, otherwise it will not be processed.

```
$ sudo apt-get install -y ca-certificates
$ sudo cp local-ca.crt /usr/local/share/ca-certificates
$ sudo update-ca-certificates
```

After this point you can use Ubuntu's tools like `curl` and `wget` to connect to local sites.

## Converting from DER-form to PEM-form

Convert a DER-formatted certificate called `local-ca.der` to PEM form like this:

```
$ sudo openssl x509 -inform der -outform pem -in local-ca.der -out local-ca.crt
```

## The CA trust store location

The CA trust store as generated by `update-ca-certificates` is available at the following locations:

- As a single file (PEM bundle) in `/etc/ssl/certs/ca-certificates.crt`
- As an OpenSSL compatible certificate directory in `/etc/ssl/certs`

As with any other security barrier you put in place to protect your server, it is pretty tough to defend against untold damage caused by someone with physical access to your environment, for example, theft of hard drives, power or service disruption, and so on. Therefore, console security should be addressed merely as one component of your overall physical security strategy. A locked "screen door" may deter a casual criminal, or at the very least slow down a determined one, so it is still advisable to perform basic precautions with regard to console security.

The following instructions will help defend your server against issues that could otherwise yield very serious consequences.

## Disable Ctrl+Alt+Delete

Anyone that has physical access to the keyboard can simply use the Ctrl+Alt+Delete key combination to reboot the server without having to log on. While someone could simply unplug the power source, you should still prevent the use of this key combination on a production server. This forces an attacker to take more drastic measures to reboot the server, and will prevent accidental reboots at the same time.

To disable the reboot action taken by pressing the Ctrl+Alt+Delete key combination, run the following two commands:

```
sudo systemctl mask ctrl-alt-del.target
sudo systemctl daemon-reload
```

Virtualisation is being adopted in many different environments and situations. If you are a developer, virtualisation provides you with a contained environment where you can safely do almost any sort of development without messing up your main working environment. If you are a systems administrator, you can use virtualisation to more easily separate your services and move them around based on demand.

The default virtualisation technology supported by Ubuntu is [KVM](#). For Intel and AMD hardware, KVM requires virtualisation extensions. KVM is also available for IBM Z and LinuxONE, IBM POWER, and ARM64.

[QEMU](#) provides the user-space backend for the [KVM experience](#), but it also can be used for hardware without virtualisation extensions through its [Tiny Code Generator \(TCG\)](#) mode.

While virtualisation is similar to containers in many ways, they are also different. Containers are implemented via other solutions like [LXD](#), [systemd-nspawn](#), [containerd](#) and others.

[QEMU](#) is a machine emulator that can run operating systems and programs for one machine on a different machine. However, it is more often used as a virtualiser in collaboration with [KVM](#) kernel components. In that case it uses the hardware virtualisation technology to virtualise guests.

Although [QEMU](#) has a [command line interface](#) and a [monitor](#) to interact with running guests, they are typically only used for development purposes. [libvirt](#) provides an abstraction from specific versions and hypervisors and encapsulates some workarounds and best practices.

## Running QEMU/KVM

While there *are* more user-friendly and comfortable ways, the quickest way to get started with [QEMU](#) is by directly running it from the netboot ISO. You can achieve this by running the following command:

### Warning:

This example is just for illustration purposes - it is not generally recommended without verifying the checksums; [Multipass](#) and [UVTool](#) are much better ways to get actual guests easily.

```
sudo qemu-system-x86_64 -enable-kvm -cdrom http://archive.ubuntu.com/ubuntu/dists/bionic-updates/main/installer-amd64/current/images/netboot/mini.iso
```

Downloading the ISO provides for faster access at runtime. We can now allocate the space for the VM:

```
qemu-img create -f qcow2 disk.qcow 5G
```

And then we can use the disk space we have just allocated for storage by adding the argument: `-drive file=disk.qcow,format=qcow2`.

These tools can do much more, as you'll discover in their respective (long) [manpages](#). They can also be made more consumable for specific use-cases and needs through a vast selection of auxiliary tools - for example [virt-manager](#) for UI-driven use through [libvirt](#). But in general, it comes down to:

```
qemu-system-x86_64 options image[s]
```

So take a look at the [QEMU manpage](#), [qemu-img](#) and the [QEMU documentation](#) and see which options best suit your needs.

## Graphics

Graphics for [QEMU/KVM](#) always comes in two pieces: a front end and a back end.

- **frontend:** Controlled via the `-vga` argument, which is provided to the guest. Usually one of `cirrus`, `std`, `qxl`, or `virtio`. The default these days is `qxl` which strikes a good balance between guest compatibility and performance. The guest needs a driver for whichever option is selected – this is the most common reason to not use the default (e.g., on very old Windows versions).
- **backend:** Controlled via the `-display` argument. This is what the host uses to actually display the graphical content, which can be an application window via `gtk` or a `vnc`.
- In addition, one can enable the `-spice` back end (which can be done in addition to `vnc`). This can be faster and provides more authentication methods than `vnc`.
- If you want no graphical output at all, you can save some memory and CPU cycles by setting `-nographic`.

If you run with `spice` or `vnc` you can use native `vnc` tools or virtualisation-focused tools like `virt-viewer`. You can read more about these in the [libvirt section](#).

All these options are considered basic usage of graphics, but there are also advanced options for more specific use-cases. Those cases usually differ in their [ease-of-use and capability](#), such as:

- *Need 3D acceleration:* Use `-vga virtio` with a local display having a GL context `-display gtk,gl=on`. This will use `virgil3d` on the host, and guest drivers are needed (which are common in Linux since [Kernels >= 4.4](#) but can be hard to come by for other cases). While not as fast as the next two options, the major benefit is that it can be used without additional hardware and without a proper input-output memory management unit (IOMMU) [set up for device passthrough](#).
- *Need native performance:* Use PCI passthrough of additional GPUs in the system. You'll need an IOMMU set up, and you'll need to unbind the cards from the host before you can pass it through, like so:

```
-device vfio-pci,host=05:00.0,bus=1,addr=00.0,multifunction=on,x-vga=on -device vfio-pci,host=05:00.1,bus=1,addr=
```

- *Need native performance, but multiple guests per card:* Like with PCI passthrough, but using mediated devices to shard a card on the host into multiple devices, then passing those:

```
-display gtk,gl=on -device vfio-pci,sysfsdev=/sys/bus/pci/devices/0000:00:02.0/4dd511f6-ec08-11e8-b839-2f163ddee3b3,display=on,rombar=0
```

You can read more [about vGPU at kraxel](#) and [Ubuntu GPU mdev evaluation](#). The sharding of the cards is driver-specific and therefore will differ per manufacturer – Intel, Nvidia, or AMD.

The advanced cases in particular can get pretty complex – it is recommended to use QEMU through libvirt for those cases. libvirt will take care of all but the host kernel/BIOS tasks of such configurations. Below are the common basic actions needed for faster options (i.e., passthrough and mediated devices passthrough).

The initial step for both options is the same; you want to ensure your system has its IOMMU enabled and the device to pass should be in a group of its own. Enabling the VT-d and IOMMU is usually a BIOS action and thereby manufacturer dependent.

## Preparing the input-output memory management unit (IOMMU)

On the kernel side, there are various [options you can enable/configure](#) for the IOMMU feature. In recent Ubuntu Kernels (>=5.4 => Focal or Bionic-HWE kernels) everything usually works by default, unless your hardware setup makes you need any of those tuning options.

**\*\* Note \*\*:**

```
The card used in all examples below e.g. when filtering for or assigning PCI IDs, is an NVIDIA V100 on
PCI ID 41.00.0
$ lspci | grep 3D
41:00.0 3D controller: NVIDIA Corporation GV100GL [Tesla V100 PCIe 16GB] (rev a1)
```

You can check your boot-up kernel messages for IOMMU/DMAR messages or even filter it for a particular PCI ID.

To list all:

```
dmesg | grep -i -e DMAR -e IOMMU
```

Which produces an output like this:

```
[3.509232] iommu: Default domain type: Translated
...
[4.516995] pci 0000:00:01.0: Adding to iommu group 0
...
[4.702729] perf/amd_iommu: Detected AMD IOMMU #0 (2 banks, 4 counters/bank).
```

To filter for the installed 3D card:

```
dmesg | grep -i -e DMAR -e IOMMU | grep $(lspci | awk '/ 3D / {print $1}')
```

Which shows the following output:

```
[4.598150] pci 0000:41:00.0: Adding to iommu group 66
```

If you have a particular device and want to check for its group you can do that via sysfs. If you have multiple cards or want the full list you can traverse the same sysfs paths for that.

For example, to find the group for our example card:

```
find /sys/kernel/iommu_groups/ -name "$(lspci | awk '/ 3D / {print $1})*"
```

Which it tells us is found here:

```
/sys/kernel/iommu_groups/66/devices/0000:41:00.0
```

We can also check if there are other devices in this group:

```
ll /sys/kernel/iommu_groups/66/devices/
lrwxrwxrwx 1 root root 0 Jan 3 06:57 0000:41:00.0 -> ../../../../devices/pci0000:40/0000:40:03.1/0000:41:00.0/
```

Another useful tool for this stage (although the details are beyond the scope of this article) can be `virsh node*`, especially `virsh nodedev-list --tree` and `virsh nodedev-dumpxml <pcidev>`.

**\*\* Note \*\*:**

Some older or non-server boards tend to group devices in one IOMMU group, which isn't very useful as it means you'll need to pass "all or none of them" to the same guest.



## Preparations for PCI and mediated devices pass-through – block host drivers

For both, you'll want to ensure the normal driver isn't loaded. In some cases you can do that at runtime via `virsh nodedev-detach <pcidevice>`. `libvirt` will even do that automatically if, on the passthrough configuration, you have set `<hostdev mode='subsystem' type='pci' managed='yes'>`.

This usually works fine for e.g. network cards, but some other devices like GPUs do not like to be unassigned, so there the required step usually is block loading the drivers you do not want to be loaded. In our GPU example the `nouveau` driver would load and that has to be blocked. To do so you can create a `modprobe` blacklist.

```
echo "blacklist nouveau" | sudo tee /etc/modprobe.d/blacklist-nouveau.conf
echo "options nouveau modeset=0" | sudo tee -a /etc/modprobe.d/blacklist-nouveau.conf
sudo update-initramfs -u
sudo reboot
```

You can check which kernel modules are loaded and available via `lspci -v`:

```
lspci -v | grep -A 10 " 3D "
```

Which in our example shows:

```
41:00.0 3D controller: NVIDIA Corporation GV100GL [Tesla V100 PCIe 16GB] (rev a1)
...
Kernel modules: nvidiafb, nouveau
```

If the configuration did not work instead it would show:

```
Kernel driver in use: nouveau
```

## Preparations for mediated devices pass-through - driver

For PCI passthrough, the above steps would be all the preparation needed, but for mediated devices one also needs to install and set up the host driver. The example here continues with our NVIDIA V100 which is [supported and available from Nvidia](#).

There is also an Nvidia document about the same steps available on [installation and configuration of vGPU on Ubuntu](#).

Once you have the drivers from Nvidia, like `nvidia-vgpu-ubuntu-470_470.68_amd64.deb`, then install them and check (as above) that that driver is loaded. The one you need to see is `nvidia_vgpu_vfio`:

```
lsmod | grep nvidia
```

Which we can see in the output:

```
nvidia_vgpu_vfio 53248 38
nvidia 35282944 586 nvidia_vgpu_vfio
mdev 24576 2 vfio_mdev,nvidia_vgpu_vfio
drm 491520 6 drm_kms_helper,drm_vram_helper,nvidia
```

### Note:

While it works without a vGPU manager, to get the full capabilities you'll need to configure the [vGPU manager \(that came with above package\)](#) and a license server so that each guest can get a license for the vGPU provided to it. Please see [Nvidia's documentation for the license server](#). While not officially supported on Linux (as of Q1 2022), it's worthwhile to note that it runs fine on Ubuntu with `sudo apt install unzip default-jre tomcat9 liblog4j2-java libslf4j-java` using `/var/lib/tomcat9` as the server path in the license server installer.

It's also worth mentioning that the Nvidia license server will go [EOL on 31 July 2023](#). At that time, it will be replaced by the [NVIDIA License System](#).

Here is an example of those when running fine:

```
general status
$ systemctl status nvidia-vgpu-mgr
 Loaded: loaded (/lib/systemd/system/nvidia-vgpu-mgr.service; enabled; vendor preset: enabled)
 Active: active (running) since Tue 2021-09-14 07:30:19 UTC; 3min 58s ago
 Process: 1559 ExecStart=/usr/bin/nvidia-vgpu-mgr (code=exited, status=0/SUCCESS)
 Main PID: 1564 (nvidia-vgpu-mgr)
 Tasks: 1 (limit: 309020)
 Memory: 1.1M
 CGroup: /system.slice/nvidia-vgpu-mgr.service
 └─1564 /usr/bin/nvidia-vgpu-mgr
```

```

Sep 14 07:30:19 node-watt systemd[1]: Starting NVIDIA vGPU Manager Daemon...
Sep 14 07:30:19 node-watt systemd[1]: Started NVIDIA vGPU Manager Daemon.
Sep 14 07:30:20 node-watt nvidia-vgpu-mgr[1564]: notice: vmiop_env_log: nvidia-vgpu-mgr daemon started

Entries when a guest gets a vGPU passed
Sep 14 08:29:50 node-watt nvidia-vgpu-mgr[2866]: notice: vmiop_log: (0x0): gpu-pci-id : 0x4100
Sep 14 08:29:50 node-watt nvidia-vgpu-mgr[2866]: notice: vmiop_log: (0x0): vgpu_type : Quadro
Sep 14 08:29:50 node-watt nvidia-vgpu-mgr[2866]: notice: vmiop_log: (0x0): Framebuffer: 0x1dc000000
Sep 14 08:29:50 node-watt nvidia-vgpu-mgr[2866]: notice: vmiop_log: (0x0): Virtual Device Id: 0x1db4:0x1252
Sep 14 08:29:50 node-watt nvidia-vgpu-mgr[2866]: notice: vmiop_log: (0x0): FRL Value: 60 FPS
Sep 14 08:29:50 node-watt nvidia-vgpu-mgr[2866]: notice: vmiop_log: ##### vGPU Manager Information: #####
Sep 14 08:29:50 node-watt nvidia-vgpu-mgr[2866]: notice: vmiop_log: Driver Version: 470.68
Sep 14 08:29:50 node-watt nvidia-vgpu-mgr[2866]: notice: vmiop_log: (0x0): vGPU supported range: (0x70001, 0xb0001)
Sep 14 08:29:50 node-watt nvidia-vgpu-mgr[2866]: notice: vmiop_log: (0x0): Init frame copy engine: syncing...
Sep 14 08:29:50 node-watt nvidia-vgpu-mgr[2866]: notice: vmiop_log: (0x0): vGPU migration enabled
Sep 14 08:29:50 node-watt nvidia-vgpu-mgr[2866]: notice: vmiop_log: display_init inst: 0 successful

Entries when a guest grabs a license
Sep 15 06:55:50 node-watt nvidia-vgpu-mgr[4260]: notice: vmiop_log: (0x0): vGPU license state: Unlicensed (Unrestricted)
Sep 15 06:55:52 node-watt nvidia-vgpu-mgr[4260]: notice: vmiop_log: (0x0): vGPU license state: Licensed

In the guest the card is then fully recognized and enabled
$ nvidia-smi -a | grep -A 2 "Licensed Product"
 vGPU Software Licensed Product
 Product Name : NVIDIA RTX Virtual Workstation
 License Status : Licensed

```

A [mediated device](#) is essentially partitioning of a hardware device using firmware and host driver features. This brings a lot of flexibility and options; in our example we can split our 16G GPU into 2x8G, 4x4G, 8x2G or 16x1G just as we need it. The following gives an example of how to split it into two 8G cards for a compute profile and pass those to guests.

Please refer to the [Nvidia documentation](#) for advanced tunings and different card profiles.

The tool for listing and configuring these mediated devices is `mdevctl`:

```
sudo mdevctl types
```

Which will list the available types:

```

...
nvidia-300
 Available instances: 0
 Device API: vfio-pci
 Name: GRID V100-8C
 Description: num_heads=1, frl_config=60, framebuffer=8192M, max_resolution=4096x2160, max_instance=2

```

Knowing the PCI ID (`0000:41:00.0`) and the mediated device type we want (`nvidia-300`) we can now create those mediated devices:

```

$ sudo mdevctl define --parent 0000:41:00.0 --type nvidia-300
bc127e23-aaaa-4d06-a7aa-88db2dd538e0
$ sudo mdevctl define --parent 0000:41:00.0 --type nvidia-300
1360ce4b-2ed2-4f63-abb6-8cdb92100085
$ sudo mdevctl start --parent 0000:41:00.0 --uuid bc127e23-aaaa-4d06-a7aa-88db2dd538e0
$ sudo mdevctl start --parent 0000:41:00.0 --uuid 1360ce4b-2ed2-4f63-abb6-8cdb92100085

```

After that, you can check the UUID of your ready mediated devices:

```

$ sudo mdevctl list -d
bc127e23-aaaa-4d06-a7aa-88db2dd538e0 0000:41:00.0 nvidia-108 manual (active)
1360ce4b-2ed2-4f63-abb6-8cdb92100085 0000:41:00.0 nvidia-108 manual (active)

```

Those UUIDs can then be used to pass the mediated devices to the guest - which from here is rather similar to the pass through of a full PCI device.

## Passing through PCI or mediated devices

After the above setup is ready one can pass through those devices, in `libvirt` for a PCI passthrough that looks like:

```
<hostdev mode='subsystem' type='pci' managed='yes'>
 <source>
 <address domain='0x0000' bus='0x41' slot='0x00' function='0x0' />
 </source>
</hostdev>
```

And for mediated devices it is quite similar, but using the UUID.

```
<hostdev mode='subsystem' type='mdev' managed='no' model='vfio-pci' display='on'>
 <source>
 <address uuid='634fc146-50a3-4960-ac30-f09e5cedc674' />
 </source>
</hostdev>
```

Those sections can be [part of the guest definition](#) itself, to be added on guest startup and freed on guest shutdown. Or they can be in a file and used by for hot-add remove if the hardware device and its drivers support it `virsh attach-device`.

### Note:

This works great on Focal, but `type='none'` as well as `display='off'` weren't available on Bionic. If this level of control is required one would need to consider using the [Ubuntu Cloud Archive](#) or [Server-Backports](#) for a newer stack of the virtualisation components.

And finally, it might be worth noting that while mediated devices are becoming more common and known for vGPU handling, they are a general infrastructure also used (for example) for [s390x vfio-ccw](#).

## Upgrading the machine type

If you are unsure what this is, you might consider this as buying (virtual) hardware of the same spec but a newer release date. You are encouraged in general and might want to update your machine type of an existing defined guests in particular to:

- to pick up latest security fixes and features
- continue using a guest created on a now unsupported release

In general it is recommended to update machine types when upgrading QEMU/KVM to a new major version. But this can likely never be an automated task as this change is guest visible. The guest devices might change in appearance, new features will be announced to the guest and so on. Linux is usually very good at tolerating such changes, but it depends so much on the setup and workload of the guest that this has to be evaluated by the owner/admin of the system. Other operating systems were known to often be severely impacted by changing the hardware. Consider a machine type change similar to replacing all devices and firmware of a physical machine to the latest revision - all considerations that apply there apply to evaluating a machine type upgrade as well.

As usual with major configuration changes it is wise to back up your guest definition and disk state to be able to do a rollback – just in case. There is no integrated single command to update the machine type via `virsh` or similar tools. It is a normal part of your machine definition, and therefore updated the same way as most others.

First shutdown your machine and wait until it has reached that state.

```
virsh shutdown <yourmachine>
wait
virsh list --inactive
should now list your machine as "shut off"
```

Then edit the machine definition and find the type in the type tag at the machine attribute.

```
virsh edit <yourmachine>
<type arch='x86_64' machine='pc-i440fx-bionic'>hvm</type>
```

Change this to the value you want. If you need to check what types are available via “-M ?”, note that while providing upstream types as convenience only Ubuntu types are supported. There you can also see what the current default would be. In general it is strongly recommended that you change to newer types if possible to take advantage of newer features, but also to benefit from bugfixes that only apply to the newer device virtualisation.

```
kvm -M ?
lists machine types, e.g.
pc-i440fx-xenial Ubuntu 16.04 PC (i440FX + PIIX, 1996) (default)
```

```
...
pc-i440fx-bionic Ubuntu 18.04 PC (i440FX + PIIX, 1996) (default)
...
```

After this you can start your guest again. You can check the current machine type from guest and host depending on your needs.

```
virsh start <yourmachine>
check from host, via dumping the active xml definition
virsh dumpxml <yourmachine> | xmllint --xpath "string(//domain/os/type/@machine)" -
or from the guest via dmidecode (if supported)
sudo dmidecode | grep Product -A 1
 Product Name: Standard PC (i440FX + PIIX, 1996)
 Version: pc-i440fx-bionic
```

If you keep non-live definitions around - such as .xml files - remember to update those as well.

**Note:**

This also is documented along with some more constraints and considerations at the [Ubuntu Wiki](#)

## QEMU usage for microvms

QEMU became another use case being used in a container-like style providing an enhanced isolation when compared to containers, but being focused on initialisation speed.

To achieve that several components have been added:

- the [microvm machine type](#)
- alternative simple firmware (FW) that can boot linux [called qboot](#)
- QEMU build with reduced features matching these use cases called `qemu-system-x86-microvm`

For example, if you happen to already have a stripped down workload that has all it would execute in an initrd you might run it like the following:

```
sudo qemu-system-x86_64 -M ubuntu-q35 -cpu host -m 1024 -enable-kvm -serial mon:stdio -nographic -
display curses -append 'console=ttyS0,115200,8n1' -kernel vmlinuz-5.4.0-21 -initrd /boot/initrd.img-5.4.0-
21-workload
```

To run the same with microvm, qboot and the minimized qemu you would do the following:

1. Run it with with type microvm, so change -M to -M microvm.
2. Use the qboot bios, adding -bios /usr/share/qemu/bios-microvm.bin.
3. Install the feature-minimized qemu-system package, with:

```
sudo apt install qemu-system-x86-microvm
```

An invocation will now look like:

```
sudo qemu-system-x86_64 -M microvm -bios /usr/share/qemu/bios-microvm.bin -cpu host -m 1024 -enable-kvm -
serial mon:stdio -nographic -display curses -append 'console=ttyS0,115200,8n1' -kernel vmlinuz-5.4.0-21 -
initrd /boot/initrd.img-5.4.0-21-workload
```

That will cut down the qemu, bios and virtual-hw initialisation time a lot. You will now – more than you already have before – spend the majority of time inside the guest, which implies that further tuning probably has to go into that kernel and userspace initialisation time.

**Note:**

For now, microvm, the qboot BIOS and other components of this are rather new upstream and not as verified as many other parts of the virtualisation stack. Therefore, none of the above is the default. Being the default would mean many upgraders would regress finding a QEMU that doesn't have most features they are accustomed to using. Due to that the `qemu-system-x86-microvm` package is intentionally a strong opt-in conflicting with the normal `qemu-system-x86` package.

The [libvirt library](#) is used to interface with different virtualisation technologies. Before getting started with libvirt it is best to make sure your hardware supports the necessary virtualisation extensions for KVM. Enter the following from a terminal prompt:

```
kvm-ok
```

A message will be printed informing you if your CPU *does* or *does not* support hardware virtualisation.

**Note:**

On many computers with processors supporting hardware-assisted virtualisation, it is necessary to first activate an option in the BIOS to enable it.

## Virtual networking

There are a few different ways to allow a virtual machine access to the external network. The default virtual network configuration includes *bridging* and *iptables* rules implementing *usermode* networking, which uses the SLiRP protocol. Traffic is NATed through the host interface to the outside network.

To enable external hosts to directly access services on virtual machines a different type of *bridge* than the default needs to be configured. This allows the virtual interfaces to connect to the outside network through the physical interface, making them appear as normal hosts to the rest of the network.

There is a great example of [how to configure](#) a bridge and combine it with libvirt so that guests will use it at the [netplan.io](#).

## Installation

To install the necessary packages, from a terminal prompt enter:

```
sudo apt update
sudo apt install qemu-kvm libvirt-daemon-system
```

After installing `libvirt-daemon-system`, the user that will be used to manage virtual machines needs to be added to the `libvirt` group. This is done automatically for members of the `sudo` group, but needs to be done in addition for anyone else that should access system-wide libvirt resources. Doing so will grant the user access to the advanced networking options.

In a terminal enter:

```
sudo adduser $USER libvirt
```

**Note:**

If the chosen user is the current user, you will need to log out and back in for the new group membership to take effect.

You are now ready to install a *Guest* operating system. Installing a virtual machine follows the same process as installing the operating system directly on the hardware.

You will need one of the following:

- A way to automate the installation.
- A keyboard and monitor attached to the physical machine.
- To use cloud images which are meant to self-initialise (see [Multipass](#) and [UVTTool](#)).

In the case of virtual machines, a Graphical User Interface (GUI) is analogous to using a physical keyboard and mouse on a real computer. Instead of installing a GUI the `virt-viewer` or `virt-manager` application can be used to connect to a virtual machine's console using VNC. See [Virtual Machine Manager / Viewer](#) for more information.

## Virtual machine management

The following section covers the command-line tools around `virsh` that are part of libvirt itself. But there are various options at different levels of complexities and feature-sets, like:

- [Multipass](#)
- [UVTTool](#)
- [virt-\\* tools](#)
- [OpenStack](#)

### virsh

There are several utilities available to manage virtual machines and libvirt. The `virsh` utility can be used from the command line. Some examples:

- To list running virtual machines:

```
virsh list
```

- To start a virtual machine:

```
virsh start <guestname>
```

- Similarly, to start a virtual machine at boot:

```
virsh autostart <guestname>
```

- Reboot a virtual machine with:

```
virsh reboot <guestname>
```

- The *state* of virtual machines can be saved to a file in order to be restored later. The following will save the virtual machine state into a file named according to the date:

```
virsh save <guestname> save-my.state
```

Once saved the virtual machine will no longer be running.

- A saved virtual machine can be restored using:

```
virsh restore save-my.state
```

- To shutdown a virtual machine do:

```
virsh shutdown <guestname>
```

- A CDROM device can be mounted in a virtual machine by entering:

```
virsh attach-disk <guestname> /dev/cdrom /media/cdrom
```

- To change the definition of a guest virsh exposes the domain via:

```
virsh edit <guestname>
```

That will allow one to edit the [XML representation that defines the guest](#) and when saving it will apply format and integrity checks on these definitions.

Editing the XML directly certainly is the most powerful way, but also the most complex one. Tools like [Virtual Machine Manager / Viewer](#) can help inexperienced users to do most of the common tasks.

**Note:**

If `virsh` (or other `vir*` tools) connect to something other than the default `qemu-kvm/system` hypervisor, one can find alternatives for the `connect` option in `man virsh` or the [libvirt docs](#).

### system and session scope

`virsh` - as well as most other tools to manage virtualisation - can be passed connection strings.

```
virsh --connect qemu:///system
```

There are two options for the connection.

- `qemu:///system` - connect locally as root to the daemon supervising QEMU and KVM domains
- `qemu:///session` - connect locally as a normal user to their own set of QEMU and KVM domains

The *default* was always (and still is) `qemu:///system` as that is the behavior users are accustomed to. But there are a few benefits (and drawbacks) to `qemu:///session` to consider.

`qemu:///session` is per user and can – on a multi-user system – be used to separate the people.

Most importantly, processes run under the permissions of the user, which means no permission struggle on the just-downloaded image in your `$HOME` or the just-attached USB-stick.

On the other hand it can't access system resources very well, which includes network setup that is known to be hard with `qemu:///session`. It falls back to [SLiRP networking](#) which is functional but slow and makes it impossible to be reached from other systems.

`qemu:///system` is different in that it is run by the global system-wide libvirt that can arbitrate resources as needed. But you might need to `mv` and/or `chown` files to the right places and change permissions to have them usable.

Applications will usually decide on their primary use-case. Desktop-centric applications often choose `qemu:///session` while most solutions that involve an administrator anyway continue to default to `qemu:///system`.

**Further reading:**

There is more information about that in the [libvirt FAQ](#) and this [blog post](#) about the topic.

## Migration

There are different types of migration available depending on the versions of libvirt and the hypervisor being used. In general those types are:

- [Offline migration](#)
- [Live migration](#)
- [Postcopy migration](#)

There are various options to those methods, but the entry point for all of them is `virsh migrate`. Read the integrated help for more detail.

```
virsh migrate --help
```

Some useful documentation on the constraints and considerations of live migration can be found at the [Ubuntu Wiki](#).

## Device passthrough/hotplug

If, rather than the hotplugging described here, you want to always pass through a device then add the XML content of the device to your static guest XML representation via `virsh edit <guestname>`. In that case you won't need to use `attach/detach`. There are different kinds of passthrough. Types available to you depend on your hardware and software setup.

- USB hotplug/passthrough
- VF hotplug/Passthrough

Both kinds are handled in a very similar way and while there are various way to do it (e.g. also via QEMU monitor) driving such a change via libvirt is recommended. That way, libvirt can try to manage all sorts of special cases for you and also somewhat masks version differences.

In general when driving hotplug via libvirt you create an XML snippet that describes the device just as you would do in a static [guest description](#). A USB device is usually identified by vendor/product ID:

```
<hostdev mode='subsystem' type='usb' managed='yes'>
 <source>
 <vendor id='0x0b6d' />
 <product id='0x3880' />
 </source>
</hostdev>
```

Virtual functions are usually assigned via their PCI ID (domain, bus, slot, function).

```
<hostdev mode='subsystem' type='pci' managed='yes'>
 <source>
 <address domain='0x0000' bus='0x04' slot='0x10' function='0x0' />
 </source>
</hostdev>
```

### Note:

To get the virtual function in the first place is very device dependent and can therefore not be fully covered here. But in general it involves setting up an IOMMU, registering via [VFIO](#) and sometimes requesting a number of VFs. Here an example on ppc64el to get 4 VFs on a device:

```
$ sudo modprobe vfio-pci
identify device
$ lspci -n -s 0005:01:01.3
0005:01:01.3 0200: 10df:e228 (rev 10)
register and request VFs
$ echo 10df e228 | sudo tee /sys/bus/pci/drivers/vfio-pci/new_id
$ echo 4 | sudo tee /sys/bus/pci/devices/0005\:01\:00.0/sriov_numvfs
```

You then attach or detach the device via libvirt by relating the guest with the XML snippet.

```
virsh attach-device <guestname> <device-xml>
Use the Device in the Guest
virsh detach-device <guestname> <device-xml>
```

## Access QEMU Monitor via libvirt

The [QEMU Monitor](#) is the way to interact with QEMU/KVM while a guest is running. This interface has many powerful features for experienced users. When running under libvirt, the monitor interface is bound by libvirt itself for management purposes, but a user can still run QEMU monitor commands via libvirt. The general syntax is `virsh qemu-monitor-command [options] [guest] 'command'`.

Libvirt covers most use cases needed, but if you ever want/need to work around libvirt or want to tweak very special options you can e.g. add a device as follows:

```
virsh qemu-monitor-command --hmp focal-test-log 'drive_add 0 if=none,file=/var/lib/libvirt/images/test.img,format=raw,i
```

But since the monitor is so powerful, you can do a lot – especially for debugging purposes like showing the guest registers:

```
virsh qemu-monitor-command --hmp y-ipns 'info registers'
RAX=00ffffc000000000 RBX=ffff8f0f5d5c7e48 RCX=0000000000000000 RDX=ffffea00007571c0
RSI=0000000000000000 RDI=ffff8f0fd5c7e48 RBP=ffff8f0f5d5c7e18 RSP=ffff8f0f5d5c7df8
[...]
```

## Huge pages

Using huge pages can help to reduce TLB pressure, page table overhead and speed up some further memory relate actions. Furthermore by default [transparent huge pages](#) are useful, but can be quite some overhead - so if it is clear that using huge pages is preferred then making them explicit usually has some gains.

While huge page are admittedly harder to manage (especially later in the system's lifetime if memory is fragmented) they provide a useful boost especially for rather large guests.

### Bonus:

When using device passthrough on very large guests there is an extra benefit of using huge pages as it is faster to do the initial memory clear on VFIO DMA pin.

## Huge page allocation

Huge pages come in different sizes. A *normal* page is usually 4k and huge pages are either 2M or 1G, but depending on the architecture other options are possible.

The simplest yet least reliable way to allocate some huge pages is to just echo a value to `sysfs`:

```
echo 256 | sudo tee /sys/kernel/mm/hugepages/hugepages-2048kB/nr_hugepages
```

Be sure to re-check if it worked:

```
cat /sys/kernel/mm/hugepages/hugepages-2048kB/nr_hugepages
```

```
256
```

There one of these sizes is “default huge page size” which will be used in the auto-mounted `/dev/hugepages`. Changing the default size requires a reboot and is set via `default_hugepagesz`.

You can check the current default size:

```
grep Hugepagesize /proc/meminfo
```

```
Hugepagesize: 2048 kB
```

But there can be more than one at the same time – so it's a good idea to check:

```
$ tail /sys/kernel/mm/hugepages/hugepages-*/nr_hugepages`
==> /sys/kernel/mm/hugepages/hugepages-1048576kB/nr_hugepages <==
0
==> /sys/kernel/mm/hugepages/hugepages-2048kB/nr_hugepages <==
2
```

And even that could – on bigger systems – be further split per [Numa node](#).

One can allocate huge pages at [boot or runtime](#), but due to fragmentation there are no guarantees it works later. The [kernel documentation](#) lists details on both ways.

Huge pages need to be allocated by the kernel as mentioned above but to be consumable they also have to be mounted. By default, `systemd` will make `/dev/hugepages` available for the default huge page size.



Feel free to add more mount points if you need different sized ones. An overview can be queried with:

```
hugeadm --list-all-mounts
```

```
Mount Point Options
/dev/hugepages rw,relatime,pagesize=2M
```

A one-stop info for the overall huge page status of the system can be reported with:

```
hugeadm --explain
```

### Huge page usage in libvirt

With the above in place, libvirt can map guest memory to huge pages. In a guest definition add the most simple form of:

```
<memoryBacking>
 <hugepages/>
</memoryBacking>
```

That will allocate the huge pages using the default huge page size from an autodetected mount point.

For more control, e.g. how memory is spread over [Numa nodes](#) or which page size to use, check out the details at the [libvirt docs](#).

### AppArmor isolation

By default libvirt will spawn QEMU guests using AppArmor isolation for enhanced security. The [AppArmor rules for a guest](#) will consist of multiple elements:

- A static part that all guests share => `/etc/apparmor.d/abstractions/libvirt-qemu`
- A dynamic part created at guest start time and modified on hotplug/unplug => `/etc/apparmor.d/libvirt/libvirt-f9533e35-6b63-45f5-96be-7ccc9696d5e.files`

Of the above, the former is provided and updated by the `libvirt-daemon` package and the latter is generated on guest start. Neither of the two should be manually edited. They will, by default, cover the vast majority of use cases and work fine. But there are certain cases where users either want to:

- Further lock down the guest, e.g. by explicitly denying access that usually would be allowed.
- Open up the guest isolation. Most of the time this is needed if the setup on the local machine does not follow the commonly used paths.

To do so there are two files. Both are local overrides which allow you to modify them without getting them clobbered or command file prompts on package upgrades.

- `/etc/apparmor.d/local/abstractions/libvirt-qemu`  
This will be applied to every guest. Therefore it is a rather powerful (if blunt) tool. It is a quite useful place to add additional [deny rules](#).
- `/etc/apparmor.d/local/usr.lib.libvirt.virt-aa-helper`  
The above-mentioned *dynamic part* that is individual per guest is generated by a tool called `libvirt.virt-aa-helper`. That is under AppArmor isolation as well. This is most commonly used if you want to use uncommon paths as it allows one to have those uncommon paths in the [guest XML](#) (see `virsh edit`) and have those paths rendered to the per-guest dynamic rules.

### Sharing files between Host<->Guest

To be able to exchange data, the memory of the guest has to be allocated as “shared”. To do so you need to add the following to the guest config:

```
<memoryBacking>
 <access mode='shared' />
</memoryBacking>
```

For performance reasons (it helps `virtiofs`, but also is generally wise to consider) it is recommended to use huge pages which then would look like:

```
<memoryBacking>
 <hugepages>
 <page size='2048' unit='KiB' />
 </hugepages>
 <access mode='shared' />
```

```
</memoryBacking>
```

In the guest definition one then can add `filesystem` sections to specify host paths to share with the guest. The *target dir* is a bit special as it isn't really a directory – instead it is a *tag* that in the guest can be used to access this particular `virtiofs` instance.

```
<filesystem type='mount' accessmode='passthrough'>
 <driver type='virtiofs' />
 <source dir='/var/guests/h-virtiofs' />
 <target dir='myfs' />
</filesystem>
```

And in the guest this can now be used based on the tag `myfs` like:

```
sudo mount -t virtiofs myfs /mnt/
```

Compared to other Host/Guest file sharing options – commonly Samba, NFS or 9P – `virtiofs` is usually much faster and also more compatible with usual file system semantics. For some extra compatibility in regard to filesystem semantics one can add:

```
<binary xattr='on'>
 <lock posix='on' flock='on' />
</binary>
```

See the [libvirt domain/filesystem](#) documentation for further details on these.

**Note:**

While `virtiofs` works with  $\geq 20.10$  (Groovy), with  $\geq 21.04$  (Hirsute) it became more comfortable, especially in small environments (no hard requirement to specify guest Numa topology, no hard requirement to use huge pages). If needed to set up on 20.10 or just interested in those details - the libvirt [knowledge-base about virtiofs](#) holds more details about these.

## Resources

- See the [KVM home page](#) for more details.
- For more information on libvirt see the [libvirt home page](#).
  - XML configuration of [domains](#) and [storage](#) are the most often used libvirt reference.
- Another good resource is the [Ubuntu Wiki KVM](#) page.
- For basics on how to assign VT-d devices to QEMU/KVM, please see the [linux-kvm](#) page.

OpenStack is the most popular open source cloud computing platform that enables the management of distributed compute, network and storage resources in the data centre.

## OpenStack introduction

While the reference virtualisation stack, consisting of [QEMU/KVM](#) and [libvirt](#) enables hardware virtualisation and the management of virtual machines (VMs) on a single host, in most of the cases compute, network and storage resources are distributed across multiple hosts in the data centre. This creates a challenge with centralised management of those resources, scheduling VMs, etc. OpenStack solves this problem by aggregating distributed pools of resources, allocating them to VMs on-demand and enabling automated VM provisioning through a self-service portal.

OpenStack consists of the following primary components:

- **Keystone:**  
Serves as an identity service, providing authentication and authorisation functions for the users and enabling multi-tenancy.
- **Glance:**  
This is an image service, responsible for uploading, managing and retrieving cloud images for VMs running on OpenStack.
- **Nova:**  
This is the primary compute engine of OpenStack, responsible for VM scheduling, creation and termination.
- **Neutron:**  
Provides network connectivity between VMs, enabling multi-VM deployments.

- **Cinder:**  
This is a storage component that is responsible for provisioning, management and termination of persistent block devices.
- **Swift:**  
This is another storage component that provides a highly available and scalable object storage service.

There are also many other OpenStack components and supporting services available in the OpenStack ecosystem, enabling more advanced functions, such as load balancing, secrets management, etc.

## OpenStack installation

The most straightforward way to get started with OpenStack on Ubuntu is to use [MicroStack](#) since the entire installation process requires only 2 commands and takes around 20 minutes.

Apart from MicroStack, multiple different installation methods for OpenStack on Ubuntu are available. These include:

- [OpenStack Charms](#)
- [OpenStack Ansible](#)
- [Manual Installation](#)
- [DevStack](#)

[Multipass](#) is the recommended method for creating Ubuntu VMs on Ubuntu. It's designed for developers who want a fresh Ubuntu environment with a single command, and it works on Linux, Windows and macOS.

On Linux it's available as a snap:

```
sudo snap install multipass
```

## Find available images

To find available images you can use the `multipass find` command, which will produce a list like this:

Image	Aliases	Version	Description
snapcraft:core18	18.04	20201111	Snapcraft builder for Core 18
snapcraft:core20	20.04	20210921	Snapcraft builder for Core 20
snapcraft:core22	22.04	20220426	Snapcraft builder for Core 22
snapcraft:devel		20221128	Snapcraft builder for the devel series
core	core16	20200818	Ubuntu Core 16
core18		20211124	Ubuntu Core 18
18.04	bionic	20221117	Ubuntu 18.04 LTS
20.04	focal	20221115.1	Ubuntu 20.04 LTS
22.04	jammy,lts	20221117	Ubuntu 22.04 LTS
22.10	kinetic	20221101	Ubuntu 22.10
daily:23.04	devel,lunar	20221127	Ubuntu 23.04
appliance:adguard-home		20200812	Ubuntu AdGuard Home Appliance
appliance:mosquitto		20200812	Ubuntu Mosquitto Appliance
appliance:nextcloud		20200812	Ubuntu Nextcloud Appliance
appliance:openhav		20200812	Ubuntu openHAB Home Appliance
appliance:plexmediaserver		20200812	Ubuntu Plex Media Server Appliance
anbox-cloud-appliance		latest	Anbox Cloud Appliance
charm-dev		latest	A development and testing environment for charmers
docker		latest	A Docker environment with Portainer and related tools
jellyfin	latest		Jellyfin is a Free Software Media System that puts you in control of managing your media
minikube		latest	minikube is local Kubernetes

## Launch a fresh instance of the current Ubuntu LTS

```
$ multipass launch ubuntu
Launched: cleansing-guanaco
```

## Check out the running instances

```
$ multipass list
Name State IPv4 Image
cleansing-guanaco Running 10.140.26.17 Ubuntu 22.04 LTS
```

## Learn more about the VM instance you just launched

```
$ multipass info cleansing-guanaco
Name: cleansing-guanaco
State: Running
IPv4: 10.140.26.17
Release: Ubuntu 22.04.1 LTS
Image hash: dc5b5a43c267 (Ubuntu 22.04 LTS)
Load: 0.45 0.19 0.07
Disk usage: 1.4G out of 4.7G
Memory usage: 168.3M out of 969.5M
Mounts: --
```

## Connect to a running instance

```
$ multipass shell cleansing-guanaco
Welcome to Ubuntu 22.04.1 LTS (GNU/Linux 5.15.0-53-generic x86_64)
(...)
$
```

Don't forget to logout (or Ctrl-D) or you may find yourself heading all the



way down the Inception levels...

## Run commands inside an instance from outside

```
$ multipass exec cleansing-guanaco -- lsb_release -a
No LSB modules are available.
Distributor ID: Ubuntu
Description: Ubuntu 22.04.1 LTS
Release: 22.04
Codename: jammy
```

## Stop an instance to save resources

```
$ multipass stop cleansing-guanaco
```

## Delete the instance

```
$ multipass delete cleansing-guanaco
```

It will now show up as deleted:

```
$ multipass list
Name State IPv4 Image
cleansing-guanaco Deleted -- Not Available
```

And when you want to completely get rid of it:

```
$ multipass purge
```

## Integrate into the rest of your virtualisation

You might have other virtualisation already based on libvirt, either through using the similar older `uvtool` or through the more common [virt-manager](#).

You might, for example, want those guests to be on the same bridge to communicate to each other or you need access to the graphical output for some reason.

Fortunately it is possible to integrate this by using the `libvirt` backend of multipass:

```
$ sudo multipass set local.driver=libvirt
```

After that when you start a guest you can also access it via tools like [virt-manager](#) or `virsh`:

```
$ multipass launch ubuntu
Launched: engaged-amberjack
```

```
$ virsh list
 Id Name State

 15 engaged-amberjack running
```

## Get help

```
multipass help
multipass help <command>
```

See the [Multipass documentation](#) for more details.

With Ubuntu being one of the most used operating systems on many cloud platforms, the availability of stable and secure cloud images has become very important. As of 12.04 the use of cloud images outside of a cloud infrastructure has been improved. It is now possible to use those images to create a virtual machine without needing a complete installation.

## Creating virtual machines using uvtool

Starting with 14.04 LTS, a tool called `uvtool` has greatly facilitated the creation of virtual machines (VM) using cloud images. `uvtool` provides a simple mechanism for synchronising cloud images locally and using them to create new VMs in minutes.

### Install uvtool packages

The following packages and their dependencies will be required in order to use `uvtool`:

- `uvtool`
- `uvtool-libvirt`

To install `uvtool`, run:

```
sudo apt -y install uvtool
```

This will install `uvtool`'s main commands, `uvt-simplestreams-libvirt` and `uvt-kvm`.

### Get the Ubuntu cloud image with uvt-simplestreams-libvirt

This is one of the major simplifications that `uvtool` brings. It knows where to find the cloud images so only one command is required to get a new cloud image. For instance, if you want to synchronise all cloud images for the amd64 architecture, the `uvtool` command would be:

```
uvt-simplestreams-libvirt --verbose sync arch=amd64
```

After all the images are downloaded from the Internet, you will have a complete set of locally-stored cloud images. To see what has been downloaded, use the following command:

```
uvt-simplestreams-libvirt query
release=bionic arch=amd64 label=daily (20191107)
release=focal arch=amd64 label=daily (20191029)
...
```

In the case where you want to synchronise only one specific cloud image, you need to use the `release=` and `arch=` filters to identify which image needs to be synchronised.

```
uvt-simplestreams-libvirt sync release=DISTRO-SHORT-CODENAME arch=amd64
```

Furthermore, you can provide an alternative URL to fetch images from. A common case is the daily image, which helps you get the very latest images, or if you need access to the not-yet-released development release of Ubuntu. As an example:

```
uvt-simplestreams-libvirt sync --source http://cloud-images.ubuntu.com/daily [... further options]
```

## Create the VM using uvt-kvm

In order to connect to the virtual machine once it has been created, you must have a valid SSH key available for the Ubuntu user. If your environment does not have an SSH key, you can easily create one using the `ssh-keygen` command, which will produce similar output to this:

```
Generating public/private rsa key pair.
Enter file in which to save the key (/home/ubuntu/.ssh/id_rsa):
Enter passphrase (empty for no passphrase):
Enter same passphrase again:
Your identification has been saved in /home/ubuntu/.ssh/id_rsa.
Your public key has been saved in /home/ubuntu/.ssh/id_rsa.pub.
The key fingerprint is:
4d:ba:5d:57:c9:49:ef:b5:ab:71:14:56:6e:2b:ad:9b ubuntu@DISTR0-SHORT-CODENAMES
The key's randomart image is:
+--[RSA 2048]-----+
| .. |
| o.=|
| . **|
| + o+=|
| S=.|
| o . .+ .|
| . . o o |
| * |
| E |
+-----+

```

To create of a new virtual machine using `uvttool`, run the following in a terminal:

```
uvt-kvm create firstttest
```

This will create a VM named 'firstttest' using the current locally-available LTS cloud image. If you want to specify a release to be used to create the VM, you need to use the `release=` filter:

```
uvt-kvm create secondttest release=DISTR0-SHORT-CODENAME
```

The `uvt-kvm wait` command can be used to wait until the creation of the VM has completed:

```
uvt-kvm wait secondttest
```

## Connect to the running VM

Once the virtual machine creation is completed, you can connect to it using SSH:

```
uvt-kvm ssh secondttest
```

You can also connect to your VM using a regular SSH session using the IP address of the VM. The address can be queried using the following command:

```
$ uvt-kvm ip secondttest
192.168.122.199
$ ssh -i ~/.ssh/id_rsa ubuntu@192.168.122.199
[...]
```

To run a command as administrator (user "root"), use "`sudo <command>`". See "`man sudo_root`" for details.

```
ubuntu@secondttest:~$
```

## Get the list of running VMs

You can get the list of VMs running on your system with the `uvt-kvm list` command.

## Destroy your VM

Once you are done with your VM, you can destroy it with:

```
uvt-kvm destroy secondttest
```

### Note:

Unlike `libvirt`'s `destroy` or `undefine` actions, this will (by default) also remove the associated virtual storage files.

## More uvt-kvm options

The following options can be used to change some of the characteristics of the VM that you are creating:

- `--memory` : Amount of RAM in megabytes. Default: 512.
- `--disk` : Size of the OS disk in gigabytes. Default: 8.
- `--cpu` : Number of CPU cores. Default: 1.

Some other parameters will have an impact on the cloud-init configuration:

- `--password <password>` : Allow login to the VM using the Ubuntu account and this provided password.
- `--run-script-once <script_file>` : Run `script_file` as root on the VM the first time it is booted, but never again.
- `--packages <package_list>` : Install the comma-separated packages specified in `package_list` on first boot.

A complete description of all available modifiers is available in the manpage of `uvt-kvm`.

## Resources

If you are interested in learning more, have questions or suggestions, please contact the Ubuntu Server Team at:

- IRC: `#ubuntu-server` on libera
- Mailing list: [ubuntu-server at lists.ubuntu.com](mailto:ubuntu-server@lists.ubuntu.com)

The *virt-manager* source contains not only `virt-manager` itself but also a collection of further helpful tools like `virt-install`, `virt-clone` and `virt-viewer`.

## Virtual Machine Manager

The `virt-manager` package contains a graphical utility to manage local and remote virtual machines. To install `virt-manager`, enter:

```
sudo apt install virt-manager
```

Since `virt-manager` requires a Graphical User Interface (GUI) environment it is recommended to install it on a workstation or test machine instead of a production server. To connect to the local libvirt service enter:

```
virt-manager
```

You can connect to the libvirt service running on another host by entering the following in a terminal prompt:

```
virt-manager -c qemu+ssh://virtnode1.mydomain.com/system
```

### Note:

The above example assumes that SSH connectivity between the management system and the target system has already been configured, and uses SSH keys for authentication. SSH *keys* are needed because libvirt sends the password prompt to another process.

### virt-manager guest lifecycle

When using `virt-manager` it is always important to know the context you're looking at. The main window initially lists only the currently-defined guests. You'll see their *name*, *state* and a small chart on *CPU usage*.

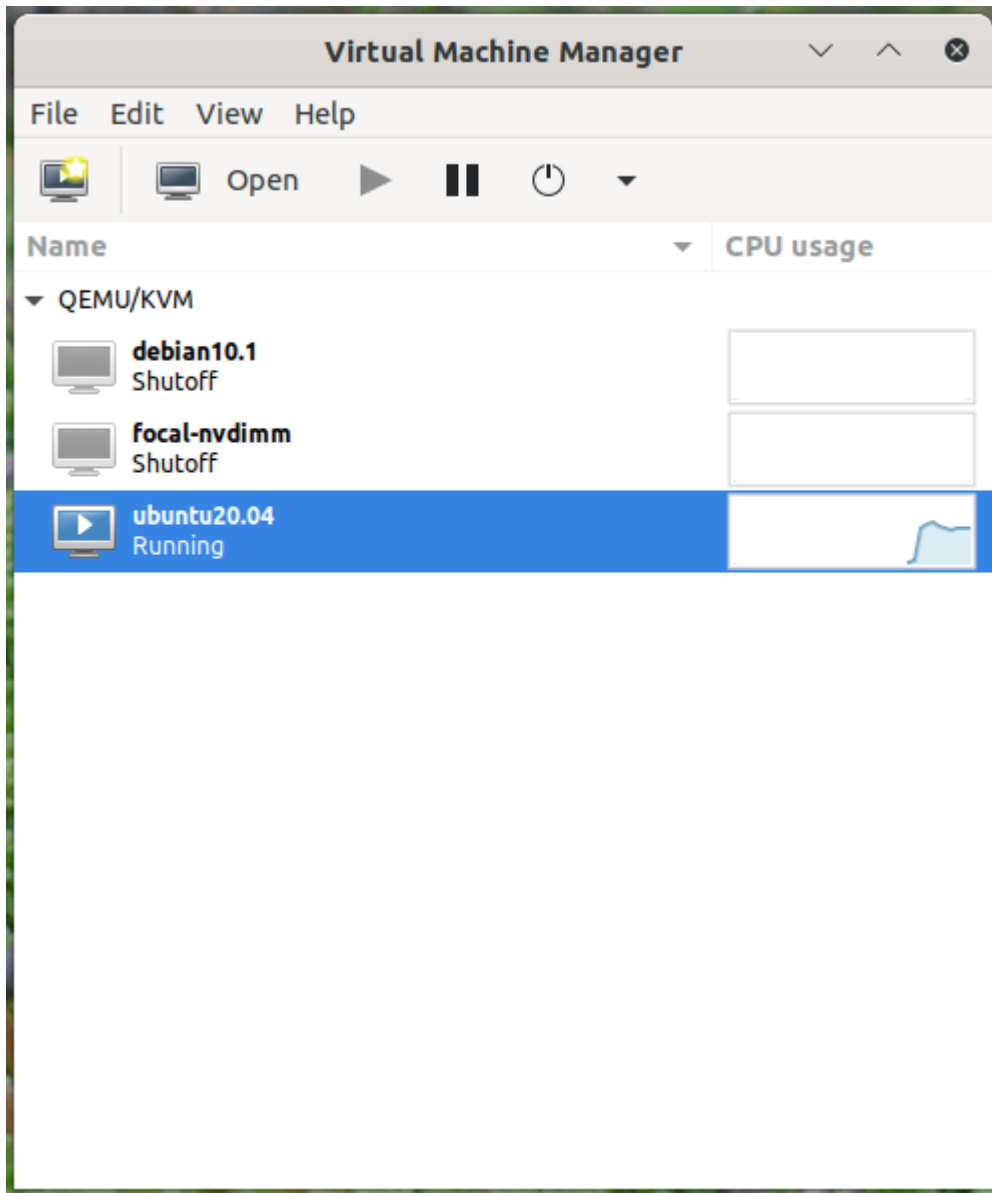

In that context there isn't much one can do except start/stop a guest. However, by double-clicking on a guest or by clicking the *open* button at the top one can see the guest itself. For a running guest that includes the guest's main-console/virtual-screen output.



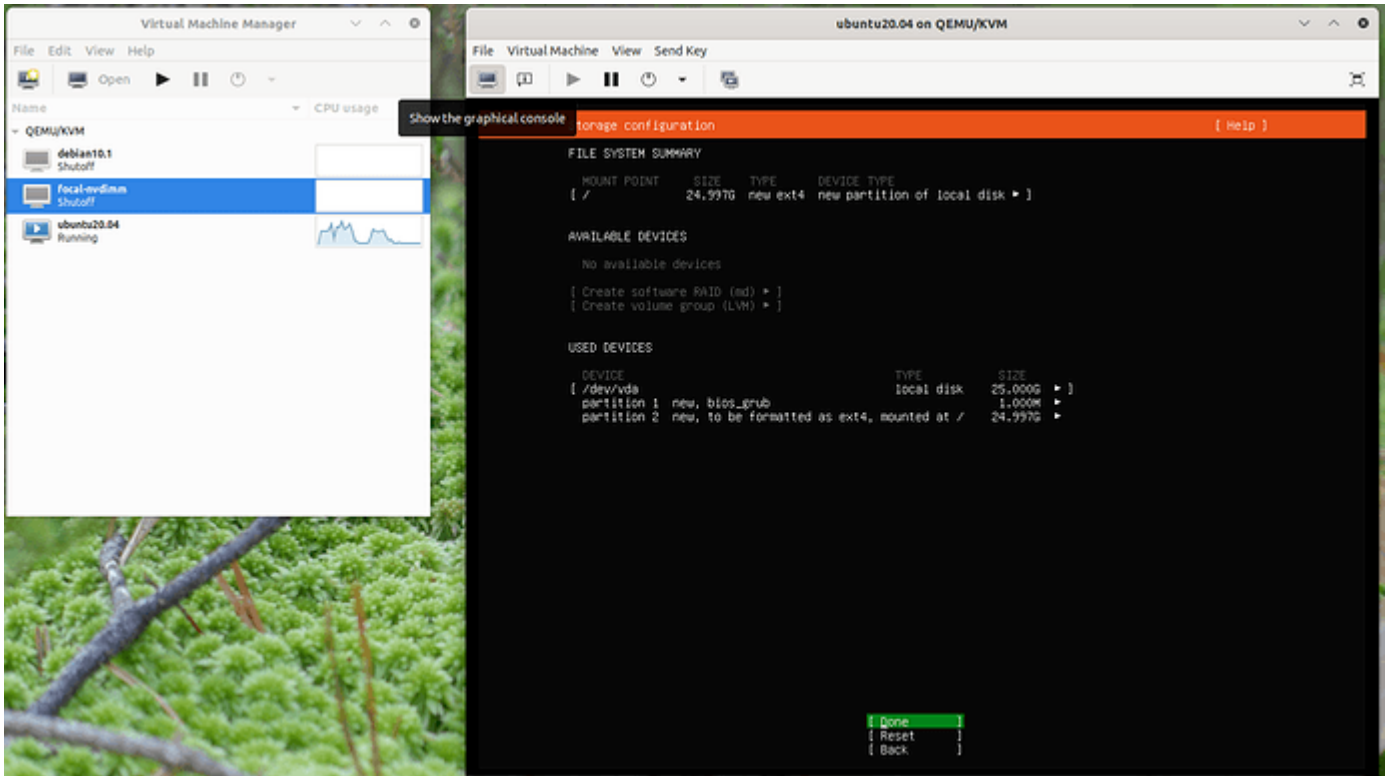

virt-manager-gui-showoutput1594×894 364 KB

If you are deeper in the guest config a click in the top left onto “*show the graphical console*” will get you back to this output.

### virt-manager guest modification

virt-manager provides a GUI-assisted way to edit guest definitions which can be handy. To do so, the per-guest context view will have “*show virtual hardware details*” at the top. Here a user can edit the virtual hardware of the guest, which will alter the [guest representation](#) behind the scenes.

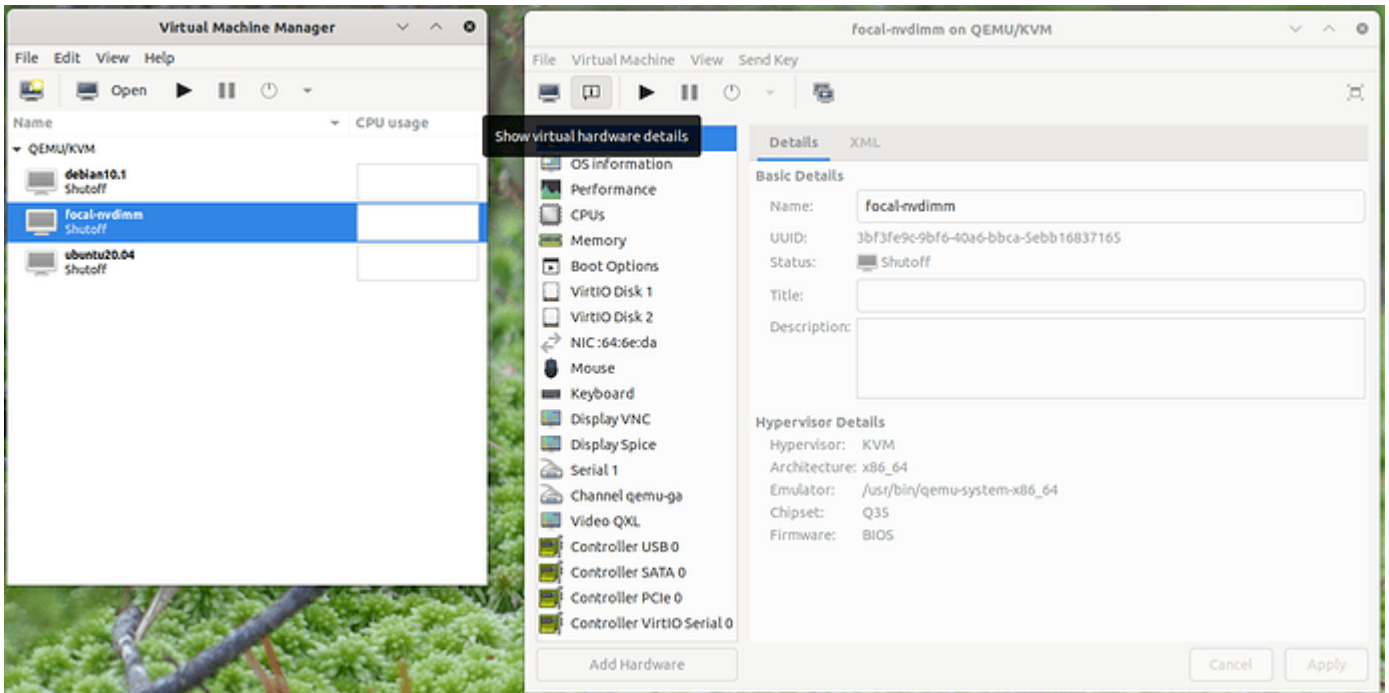

virt-manager-gui-edit1406×706 282 KB

The UI edit is limited to the features known to (and supported by) that GUI feature. Not only does libvirt grow features faster than virt-manager can keep up – adding every feature would also overload the UI and render it unusable. To strike a balance between the two, there also is the XML view which can be reached via the “*edit libvirt XML*” button.

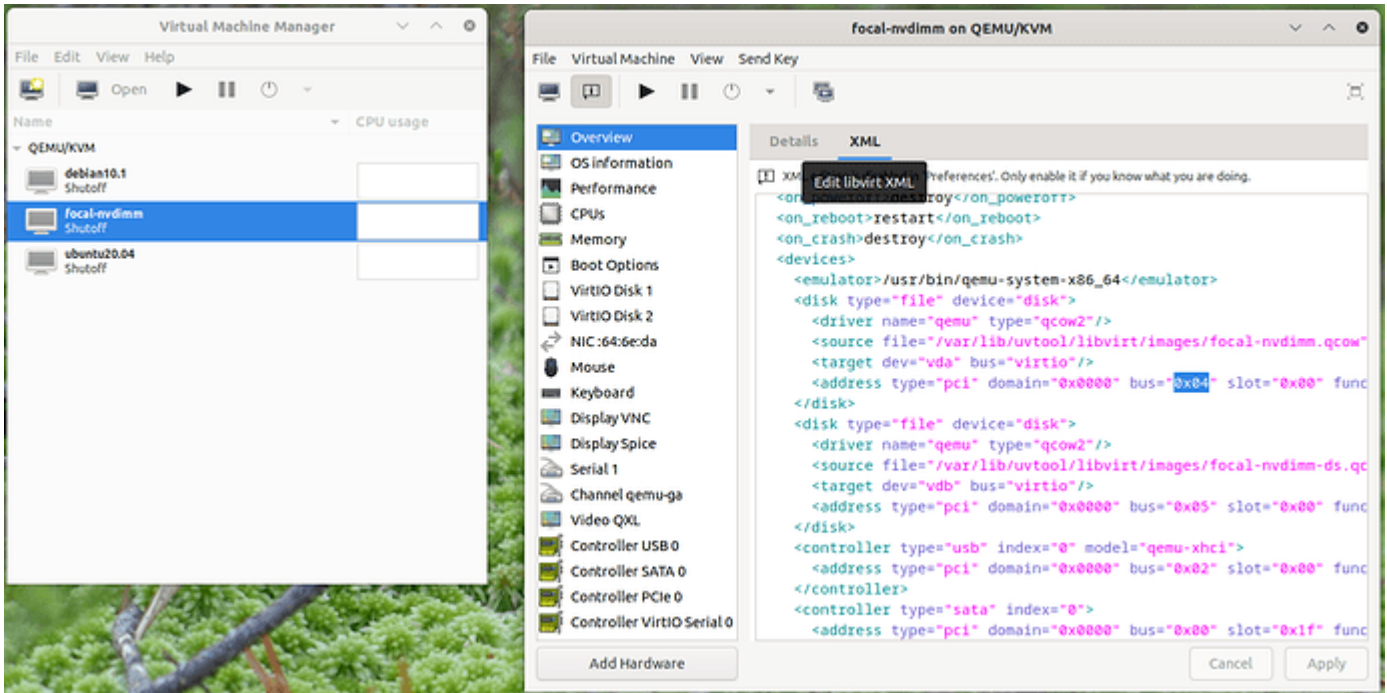

virt-manager-gui-XML1406×706 340 KB

By default this will be read-only and you can see what the UI-driven actions have changed, but one can allow read-write access in this view via the *preferences*. This is the same content that the `virsh edit` of the `libvirt-client` exposes.

## Virtual Machine Viewer

The `virt-viewer` application allows you to connect to a virtual machine's console like `virt-manager`, but reduced to the GUI functionality. `virt-viewer` does require a GUI to interface with the virtual machine.

To install `virt-viewer` from a terminal enter:

```
sudo apt install virt-viewer
```

Once a virtual machine is installed and running you can connect to the virtual machine's console by using:

```
virt-viewer <guestname>
```

The UI will be a window representing the virtual screen of the guest, just like with `virt-manager` above, but without the extra buttons and features around it.

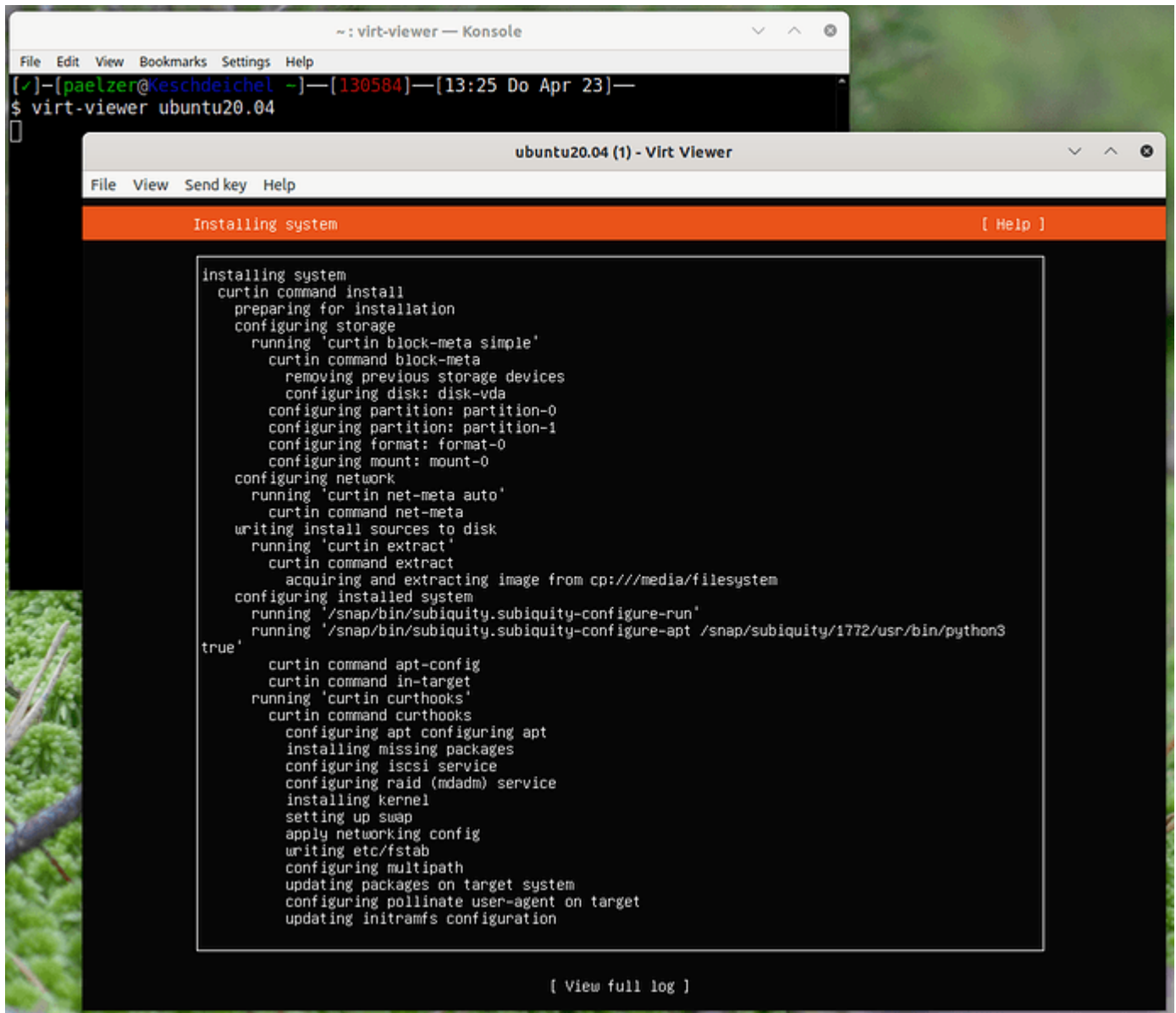

virt-viewer-gui-showoutput1105×958 164 KB

Similar to `virt-manager`, `virt-viewer` can connect to a remote host using `SSH` with key authentication, as well:

```
virt-viewer -c qemu+ssh://virtnode1.mydomain.com/system <guestname>
```

Be sure to replace `web_devel` with the appropriate virtual machine name.

If configured to use a *bridged* network interface you can also setup `SSH` access to the virtual machine.

## virt-install

`virt-install` is part of the `virtinst` package. It can help with installing classic ISO-based systems and provides a CLI for the most common options needed to do so. To install it, from a terminal prompt enter:

```
sudo apt install virtinst
```

There are several options available when using `virt-install`. For example:

```
virt-install -n web_devel -r 8192 \
--disk path=/home/doug/vm/web_devel.img,bus=virtio,size=50 \
-c focal-desktop-amd64.iso \
--network network=default,model=virtio \
--graphics vnc,listen=0.0.0.0 --noautoconsole -v --vcpus=4
```

There are many more arguments that can be found in the man page. However, explaining those of the example above one by one:

- `-n web_devel`  
The name of the new virtual machine will be `web_devel` in this example.
- `-r 8192`  
Specifies the amount of memory the virtual machine will use in megabytes.
- `--disk path=/home/doug/vm/web_devel.img,bus=virtio,size=50`  
Indicates the path to the virtual disk which can be a file, partition, or logical volume. In this example a file named `web_devel.img` in the current user's directory, with a size of 50 gigabytes, and using `virtio` for the disk bus. Depending on the disk path, `virt-install` may need to run with elevated privileges.
- `-c focal-desktop-amd64.iso`  
File to be used as a virtual CD-ROM. The file can be either an ISO file or the path to the host's CD-ROM device.
- `--network`  
Provides details related to the VM's network interface. Here the default network is used, and the interface model is configured for `virtio`.
- `--graphics vnc,listen=0.0.0.0`  
Exports the guest's virtual console using VNC and on all host interfaces. Typically servers have no GUI, so another GUI-based computer on the Local Area Network (LAN) can connect via VNC to complete the installation.
- `--noautoconsole`  
Will not automatically connect to the virtual machine's console.
- `-v` : creates a fully virtualised guest.
- `--vcpus=4` : allocate 4 virtual CPUs.

After launching `virt-install` you can connect to the virtual machine's console either locally using a GUI (if your server has a GUI), or via a remote VNC client from a GUI-based computer.

## virt-clone

The `virt-clone` application can be used to copy one virtual machine to another. For example:

```
virt-clone --auto-clone --original focal
```

Options used:

- `--auto-clone`  
To have `virt-clone` create guest names and disk paths on its own.
- `--original`  
Name of the virtual machine to copy.

Also, use the `-d` or `--debug` option to help troubleshoot problems with `virt-clone`.

Replace `focal` with the appropriate virtual machine names of your case.

### Warning:

Please be aware that this is a full clone, therefore any sorts of secrets, keys and for example `/etc/machine-id` will be shared. This will cause issues with security and anything that needs to identify the machine like DHCP. You most likely want to edit those afterwards and de-duplicate them as needed.

## Resources

- See the [KVM](#) home page for more details.
- For more information on libvirt see the [libvirt home page](#)
- The [Virtual Machine Manager](#) site has more information on `virt-manager` development.

LXD (pronounced lex-dee) is the lightervisor, or lightweight container hypervisor. LXC (lex-see) is a program which creates and administers “containers” on a local system. It also provides an API to allow higher level managers, such as LXD, to administer containers. In a sense, one could compare LXC to QEMU, while comparing LXD to libvirt.

The LXC API deals with a ‘container’. The LXD API deals with ‘remotes’, which serve images and containers. This extends the LXC functionality over the network, and allows concise management of tasks like container migration and container image publishing.

LXD uses LXC under the covers for some container management tasks. However, it keeps its own container configuration information and has its own conventions, so that it is best not to use classic LXC commands by hand with LXD containers. This document will focus on how to configure and administer LXD on Ubuntu systems.

## Online Resources

There is excellent documentation for [getting started with LXD](#) and an online server allowing you to [try out LXD remotely](#). Stéphane Graber also has an [excellent blog series](#) on LXD 2.0. Finally, there is great documentation on how to [drive lxd using juju](#).

This document will offer an Ubuntu Server-specific view of LXD, focusing on administration.

## Installation

LXD is pre-installed on Ubuntu Server cloud images. On other systems, the lxd package can be installed using:

```
sudo snap install lxd
```

This will install the self-contained LXD snap package.

## Kernel preparation

In general, Ubuntu should have all the desired features enabled by default. One exception to this is that in order to enable swap accounting the boot argument `swapaccount=1` must be set. This can be done by appending it to the `GRUB_CMDLINE_LINUX_DEFAULT=variable` in `/etc/default/grub`, then running `'update-grub'` as root and rebooting.

## Configuration

In order to use LXD, some basic settings need to be configured first. This is done by running `lxd init`, which will allow you to choose:

- Directory or [ZFS](#) container backend. If you choose ZFS, you can choose which block devices to use, or the size of a file to use as backing store.
- Availability over the network.
- A 'trust password' used by remote clients to vouch for their client certificate.

You must run `'lxd init'` as root. `'lxc'` commands can be run as any user who is a member of group `lxd`. If user `joe` is not a member of group `'lxd'`, you may run:

```
adduser joe lxd
```

as root to change it. The new membership will take effect on the next login, or after running `newgrp lxd` from an existing login.

See [How to initialize LXD](#) in the LXD documentation for more information on the configuration settings. Also, refer to the definitive configuration provided with the source code for the server, container, profile, and device configuration.

## Creating your first container

This section will describe the simplest container tasks.

### Creating a container

Every new container is created based on either an image, an existing container, or a container snapshot. At install time, LXD is configured with the following image servers:

- `ubuntu`: this serves official Ubuntu server cloud image releases.
- `ubuntu-daily`: this serves official Ubuntu server cloud images of the daily development releases.
- `images`: this is a default-installed alias for [images.linuxcontainers.org](https://images.linuxcontainers.org). This serves classical `lxc` images built using the same images which the LXC 'download' template uses. This includes various distributions and minimal custom-made Ubuntu images. This is not the recommended server for Ubuntu images.

The command to create and start a container is

```
lxc launch remote:image containername
```

Images are identified by their hash, but are also aliased. The `ubuntu` remote knows many aliases such as `18.04` and `bionic`. A list of all images available from the Ubuntu Server can be seen using:

```
lxc image list ubuntu:
```

To see more information about a particular image, including all the aliases it is known by, you can use:

```
lxc image info ubuntu:bionic
```

You can generally refer to an Ubuntu image using the release name (`bionic`) or the release number (`18.04`). In addition, `lts` is an alias for the latest supported LTS release. To choose a different architecture, you can specify the desired architecture:

```
lxc image info ubuntu:lts/arm64
```

Now, let's start our first container:

```
lxc launch ubuntu:bionic b1
```

This will download the official current Bionic cloud image for your current architecture, then create a container named `b1` using that image, and finally start it. Once the command returns, you can see it using:

```
lxc list
lxc info b1
```

and open a shell in it using:

```
lxc exec b1 -- bash
```

A convenient alias for the command above is:

```
lxc shell b1
```

The try-it page mentioned above gives a full synopsis of the commands you can use to administer containers.

Now that the `bionic` image has been downloaded, it will be kept in `sync` until no new containers have been created based on it for (by default) 10 days. After that, it will be deleted.

## LXD Server Configuration

By default, LXD is socket activated and configured to listen only on a local UNIX socket. While LXD may not be running when you first look at the process listing, any LXC command will start it up. For instance:

```
lxc list
```

This will create your client certificate and contact the LXD server for a list of containers. To make the server accessible over the network you can set the `http` port using:

```
lxc config set core.https_address :8443
```

This will tell LXD to listen to port 8443 on all addresses.

### Authentication

By default, LXD will allow all members of group `lxd` to talk to it over the UNIX socket. Communication over the network is authorized using server and client certificates.

Before client `c1` wishes to use remote `r1`, `r1` must be registered using:

```
lxc remote add r1 r1.example.com:8443
```

The fingerprint of `r1`'s certificate will be shown, to allow the user at `c1` to reject a false certificate. The server in turn will verify that `c1` may be trusted in one of two ways. The first is to register it in advance from any already-registered client, using:

```
lxc config trust add r1 certfile.crt
```

Now when the client adds `r1` as a known remote, it will not need to provide a password as it is already trusted by the server.

The other step is to configure a 'trust password' with `r1`, either at initial configuration using `lxd init`, or after the fact using:

```
lxc config set core.trust_password PASSWORD
```

The password can then be provided when the client registers `r1` as a known remote.

### Backing store

LXD supports several backing stores. The recommended and the default backing store is `zfs`. If you already have a ZFS pool configured, you can tell LXD to use it during the `lxd init` procedure, otherwise a file-backed `zpool` will be created automatically. With ZFS, launching a new container is fast because the filesystem starts as a copy on write clone of the images' filesystem. Note that unless the container is privileged (see below) LXD will need to change

ownership of all files before the container can start, however this is fast and change very little of the actual filesystem data.

The other supported backing stores are described in detail in the [Storage configuration](#) section of the LXD documentation.

## Container configuration

Containers are configured according to a set of profiles, described in the next section, and a set of container-specific configuration. Profiles are applied first, so that container specific configuration can override profile configuration.

Container configuration includes properties like the architecture, limits on resources such as CPU and RAM, security details including apparmor restriction overrides, and devices to apply to the container.

Devices can be of several types, including UNIX character, UNIX block, network interface, or disk. In order to insert a host mount into a container, a 'disk' device type would be used. For instance, to mount `/opt` in container `c1` at `/opt`, you could use:

```
lxc config device add c1 opt disk source=/opt path=opt
```

See:

```
lxc help config
```

for more information about editing container configurations. You may also use:

```
lxc config edit c1
```

to edit the whole of `c1`'s configuration. Comments at the top of the configuration will show examples of correct syntax to help administrators hit the ground running. If the edited configuration is not valid when the editor is exited, then the editor will be restarted.

## Profiles

Profiles are named collections of configurations which may be applied to more than one container. For instance, all containers created with `lxc launch`, by default, include the `default` profile, which provides a network interface `eth0`.

To mask a device which would be inherited from a profile but which should not be in the final container, define a device by the same name but of type 'none':

```
lxc config device add c1 eth1 none
```

## Nesting

Containers all share the same host kernel. This means that there is always an inherent trade-off between features exposed to the container and host security from malicious containers. Containers by default are therefore restricted from features needed to nest child containers. In order to run `lxc` or `lxd` containers under a `lxd` container, the `security.nesting` feature must be set to true:

```
lxc config set container1 security.nesting true
```

Once this is done, `container1` will be able to start sub-containers.

In order to run unprivileged (the default in LXD) containers nested under an unprivileged container, you will need to ensure a wide enough UID mapping. Please see the 'UID mapping' section below.

## Limits

LXD supports flexible constraints on the resources which containers can consume. The limits come in the following categories:

- CPU: limit cpu available to the container in several ways.
- Disk: configure the priority of I/O requests under load
- RAM: configure memory and swap availability
- Network: configure the network priority under load
- Processes: limit the number of concurrent processes in the container.

For a full list of limits known to LXD, see [the configuration documentation](#).

## UID mappings and Privileged containers

By default, LXD creates unprivileged containers. This means that root in the container is a non-root UID on the host. It is privileged against the resources owned by the container, but unprivileged with respect to the host, making root in a container roughly equivalent to an unprivileged user on the host. (The main exception is the increased attack surface exposed through the system call interface)

Briefly, in an unprivileged container, 65536 UIDs are 'shifted' into the container. For instance, UID 0 in the container may be 100000 on the host, UID 1 in the container is 100001, etc, up to 165535. The starting value for UIDs and GIDs, respectively, is determined by the 'root' entry the `/etc/subuid` and `/etc/subgid` files. (See the [subuid\(5\)](#) man page.)

It is possible to request a container to run without a UID mapping by setting the `security.privileged` flag to true:

```
lxc config set c1 security.privileged true
```

Note however that in this case the root user in the container is the root user on the host.

## Apparmor

LXD confines containers by default with an apparmor profile which protects containers from each other and the host from containers. For instance this will prevent root in one container from signaling root in another container, even though they have the same uid mapping. It also prevents writing to dangerous, un-namespaced files such as many sysctls and `/proc/sysrq-trigger`.

If the apparmor policy for a container needs to be modified for a container `c1`, specific apparmor policy lines can be added in the `raw.apparmor` configuration key.

## Seccomp

All containers are confined by a default seccomp policy. This policy prevents some dangerous actions such as forced umounts, kernel module loading and unloading, `kexec`, and the `open_by_handle_at` system call. The seccomp configuration cannot be modified, however a completely different seccomp policy – or none – can be requested using `raw.lxc` (see below).

## Raw LXC configuration

LXD configures containers for the best balance of host safety and container usability. Whenever possible it is highly recommended to use the defaults, and use the LXD configuration keys to request LXD to modify as needed. Sometimes, however, it may be necessary to talk to the underlying `lxc` driver itself. This can be done by specifying LXC configuration items in the 'raw.lxc' LXD configuration key. These must be valid items as documented in [the lxc.container.conf\(5\) manual page](#).

## Snapshots

Containers can be renamed and live-migrated using the `lxc move` command:

```
lxc move c1 final-beta
```

They can also be snapshotted:

```
lxc snapshot c1 YYYY-MM-DD
```

Later changes to `c1` can then be reverted by restoring the snapshot:

```
lxc restore u1 YYYY-MM-DD
```

New containers can also be created by copying a container or snapshot:

```
lxc copy u1/YYYY-MM-DD testcontainer
```

## Publishing images

When a container or container snapshot is ready for consumption by others, it can be published as a new image using:

```
lxc publish u1/YYYY-MM-DD --alias foo-2.0
```

The published image will be private by default, meaning that LXD will not allow clients without a trusted certificate to see them. If the image is safe for public viewing (i.e. contains no private information), then the 'public' flag can be set, either at publish time using

```
lxc publish u1/YYYY-MM-DD --alias foo-2.0 public=true
```



or after the fact using

```
lxc image edit foo-2.0
```

and changing the value of the public field.

## Image export and import

Image can be exported as, and imported from, tarballs:

```
lxc image export foo-2.0 foo-2.0.tar.gz
lxc image import foo-2.0.tar.gz --alias foo-2.0 --public
```

## Troubleshooting

To view debug information about LXD itself, on a systemd based host use

```
journalctl -u lxd
```

Container logfiles for container c1 may be seen using:

```
lxc info c1 --show-log
```

The configuration file which was used may be found under `/var/log/lxd/c1/lxc.conf` while apparmor profiles can be found in `/var/lib/lxd/security/apparmor/profiles/c1` and seccomp profiles in `/var/lib/lxd/security/seccomp/c1`.

Containers are a lightweight virtualization technology. They are more akin to an enhanced chroot than to full virtualization like Qemu or VMware, both because they do not emulate hardware and because containers share the same operating system as the host. Containers are similar to Solaris zones or BSD jails. Linux-vserver and OpenVZ are two pre-existing, independently developed implementations of containers-like functionality for Linux. In fact, containers came about as a result of the work to upstream the vserver and OpenVZ functionality.

There are two user-space implementations of containers, each exploiting the same kernel features. Libvirt allows the use of containers through the LXC driver by connecting to `lxc:///`. This can be very convenient as it supports the same usage as its other drivers. The other implementation, called simply 'LXC', is not compatible with libvirt, but is more flexible with more userspace tools. It is possible to switch between the two, though there are peculiarities which can cause confusion.

In this document we will mainly describe the `lxc` package. Use of `libvirt-lxc` is not generally recommended due to a lack of Apparmor protection for `libvirt-lxc` containers.

In this document, a container name will be shown as CN, C1, or C2.

## Installation

The `lxc` package can be installed using

```
sudo apt install lxc
```

This will pull in the required and recommended dependencies, as well as set up a network bridge for containers to use. If you wish to use unprivileged containers, you will need to ensure that users have sufficient allocated subuids and subgids, and will likely want to allow users to connect containers to a bridge (see *Basic unprivileged usage* below).

## Basic usage

LXC can be used in two distinct ways - privileged, by running the `lxc` commands as the root user; or unprivileged, by running the `lxc` commands as a non-root user. (The starting of unprivileged containers by the root user is possible, but not described here.) Unprivileged containers are more limited, for instance being unable to create device nodes or mount block-backed filesystems. However they are less dangerous to the host, as the root UID in the container is mapped to a non-root UID on the host.

### Basic privileged usage

To create a privileged container, you can simply do:

```
sudo lxc-create --template download --name u1
```

or, abbreviated

```
sudo lxc-create -t download -n u1
```

This will interactively ask for a container root filesystem type to download – in particular the distribution, release, and architecture. To create the container non-interactively, you can specify these values on the command line:

```
sudo lxc-create -t download -n u1 -- --dist ubuntu --release DISTRO-SHORT-CODENAME --arch amd64
```

or

```
sudo lxc-create -t download -n u1 -- -d ubuntu -r DISTRO-SHORT-CODENAME -a amd64
```

You can now use `lxc-ls` to list containers, `lxc-info` to obtain detailed container information, `lxc-start` to start and `lxc-stop` to stop the container. `lxc-attach` and `lxc-console` allow you to enter a container, if `ssh` is not an option. `lxc-destroy` removes the container, including its rootfs. See the manual pages for more information on each command. An example session might look like:

```
sudo lxc-ls --fancy
sudo lxc-start --name u1 --daemon
sudo lxc-info --name u1
sudo lxc-stop --name u1
sudo lxc-destroy --name u1
```

## User namespaces

Unprivileged containers allow users to create and administer containers without having any root privilege. The feature underpinning this is called user namespaces. User namespaces are hierarchical, with privileged tasks in a parent namespace being able to map its ids into child namespaces. By default every task on the host runs in the initial user namespace, where the full range of ids is mapped onto the full range. This can be seen by looking at `/proc/self/uid_map` and `/proc/self/gid_map`, which both will show `0 0 4294967295` when read from the initial user namespace. As of Ubuntu 14.04, when new users are created they are by default offered a range of UIDs. The list of assigned ids can be seen in the files `/etc/subuid` and `/etc/subgid`. See their respective manpages for more information. Subuids and subgids are by convention started at id 100000 to avoid conflicting with system users.

If a user was created on an earlier release, it can be granted a range of ids using `usermod`, as follows:

```
sudo usermod -v 100000-200000 -w 100000-200000 user1
```

The programs `newuidmap` and `newgidmap` are `setuid-root` programs in the `uidmap` package, which are used internally by `lxc` to map subuids and subgids from the host into the unprivileged container. They ensure that the user only maps ids which are authorized by the host configuration.

## Basic unprivileged usage

To create unprivileged containers, a few first steps are needed. You will need to create a default container configuration file, specifying your desired id mappings and network setup, as well as configure the host to allow the unprivileged user to hook into the host network. The example below assumes that your mapped user and group id ranges are 100000–165536. Check your actual user and group id ranges and modify the example accordingly:

```
grep $USER /etc/subuid
grep $USER /etc/subgid

mkdir -p ~/.config/lxc
echo "lxc.id_map = u 0 100000 65536" > ~/.config/lxc/default.conf
echo "lxc.id_map = g 0 100000 65536" >> ~/.config/lxc/default.conf
echo "lxc.network.type = veth" >> ~/.config/lxc/default.conf
echo "lxc.network.link = lxcbr0" >> ~/.config/lxc/default.conf
echo "$USER veth lxcbr0 2" | sudo tee -a /etc/lxc/lxc-usernet
```

After this, you can create unprivileged containers the same way as privileged ones, simply without using `sudo`.

```
lxc-create -t download -n u1 -- -d ubuntu -r DISTRO-SHORT-CODENAME -a amd64
lxc-start -n u1 -d
lxc-attach -n u1
lxc-stop -n u1
lxc-destroy -n u1
```

## Nesting

In order to run containers inside containers - referred to as nested containers - two lines must be present in the parent container configuration file:

```
lxc.mount.auto = cgroup
lxc.aa_profile = lxc-container-default-with-nesting
```

The first will cause the cgroup manager socket to be bound into the container, so that lxc inside the container is able to administer cgroups for its nested containers. The second causes the container to run in a looser Apparmor policy which allows the container to do the mounting required for starting containers. Note that this policy, when used with a privileged container, is much less safe than the regular policy or an unprivileged container. See the *Apparmor* section for more information.

## Global configuration

The following configuration files are consulted by LXC. For privileged use, they are found under `/etc/lxc`, while for unprivileged use they are under `~/.config/lxc`.

- `lxc.conf` may optionally specify alternate values for several lxc settings, including the `lxcpath`, the default configuration, cgroups to use, a cgroup creation pattern, and storage backend settings for `lvm` and `zfs`.
- `default.conf` specifies configuration which every newly created container should contain. This usually contains at least a network section, and, for unprivileged users, an id mapping section
- `lxc-usernet.conf` specifies how unprivileged users may connect their containers to the host-owned network.

`lxc.conf` and `default.conf` are both under `/etc/lxc` and `$HOME/.config/lxc`, while `lxc-usernet.conf` is only host-wide.

By default, containers are located under `/var/lib/lxc` for the root user.

## Networking

By default LXC creates a private network namespace for each container, which includes a layer 2 networking stack. Containers usually connect to the outside world by either having a physical NIC or a veth tunnel endpoint passed into the container. LXC creates a NATed bridge, `lxcbro`, at host startup. Containers created using the default configuration will have one veth NIC with the remote end plugged into the `lxcbro` bridge. A NIC can only exist in one namespace at a time, so a physical NIC passed into the container is not usable on the host.

It is possible to create a container without a private network namespace. In this case, the container will have access to the host networking like any other application. Note that this is particularly dangerous if the container is running a distribution with `upstart`, like Ubuntu, since programs which talk to `init`, like `shutdown`, will talk over the abstract Unix domain socket to the host's `upstart`, and shut down the host.

To give containers on `lxcbro` a persistent ip address based on domain name, you can write entries to `/etc/lxc/dnsmasq.conf` like:

```
dhcp-host=lxcmail,10.0.3.100
dhcp-host=ttrss,10.0.3.101
```

If it is desirable for the container to be publicly accessible, there are a few ways to go about it. One is to use `iptables` to forward host ports to the container, for instance

```
iptables -t nat -A PREROUTING -p tcp -i eth0 --dport 587 -j DNAT \
 --to-destination 10.0.3.100:587
```

Then, specify the host's bridge in the container configuration file in place of `lxcbro`, for instance

```
lxc.network.type = veth
lxc.network.link = br0
```

Finally, you can ask LXC to use `macvlan` for the container's NIC. Note that this has limitations and depending on configuration may not allow the container to talk to the host itself. Therefore the other two options are preferred and more commonly used.

There are several ways to determine the ip address for a container. First, you can use `lxc-ls --fancy` which will print the ip addresses for all running containers, or `lxc-info -i -H -n C1` which will print C1's ip address. If `dnsmasq` is installed on the host, you can also add an entry to `/etc/dnsmasq.conf` as follows

```
server=/lxc/10.0.3.1
```

after which `dnsmasq` will resolve `C1.lxc` locally, so that you can do:

```
ping C1
ssh C1
```

For more information, see the `lxc.conf(5)` manpage as well as the example network configurations under `/usr/share/doc/lxc/examples/`.

## LXC startup

LXC does not have a long-running daemon. However it does have three upstart jobs.

- `/etc/init/lxc-net.conf`: is an optional job which only runs if `/etc/default/lxc-net` specifies `USE_LXC_BRIDGE` (true by default). It sets up a NATed bridge for containers to use.
- `/etc/init/lxc.conf` loads the lxc apparmor profiles and optionally starts any autostart containers. The autostart containers will be ignored if `LXC_AUTO` (true by default) is set to true in `/etc/default/lxc`. See the `lxc-autostart` manual page for more information on autostarted containers.
- `/etc/init/lxc-instance.conf` is used by `/etc/init/lxc.conf` to autostart a container.

## Backing Stores

LXC supports several backing stores for container root filesystems. The default is a simple directory backing store, because it requires no prior host customization, so long as the underlying filesystem is large enough. It also requires no root privilege to create the backing store, so that it is seamless for unprivileged use. The rootfs for a privileged directory backed container is located (by default) under `/var/lib/lxc/C1/rootfs`, while the rootfs for an unprivileged container is under `~/.local/share/lxc/C1/rootfs`. If a custom `lxcpath` is specified in `lxc.system.com`, then the container rootfs will be under `$lxcpath/C1/rootfs`.

A snapshot clone C2 of a directory backed container C1 becomes an overlayfs backed container, with a rootfs called `overlayfs:/var/lib/lxc/C1/rootfs:/var/lib/lxc/C2/delta0`. Other backing store types include `loop`, `btrfs`, `LVM` and `zfs`.

A `btrfs` backed container mostly looks like a directory backed container, with its root filesystem in the same location. However, the root filesystem comprises a subvolume, so that a snapshot clone is created using a subvolume snapshot.

The root filesystem for an LVM backed container can be any separate LV. The default VG name can be specified in `lxc.conf`. The filesystem type and size are configurable per-container using `lxc-create`.

The rootfs for a `zfs` backed container is a separate `zfs` filesystem, mounted under the traditional `/var/lib/lxc/C1/rootfs` location. The `zfsroot` can be specified at `lxc-create`, and a default can be specified in `lxc.system.conf`.

More information on creating containers with the various backing stores can be found in the `lxc-create` manual page.

## Templates

Creating a container generally involves creating a root filesystem for the container. `lxc-create` delegates this work to *templates*, which are generally per-distribution. The lxc templates shipped with lxc can be found under `/usr/share/lxc/templates`, and include templates to create Ubuntu, Debian, Fedora, Oracle, centos, and gentoo containers among others.

Creating distribution images in most cases requires the ability to create device nodes, often requires tools which are not available in other distributions, and usually is quite time-consuming. Therefore lxc comes with a special *download* template, which downloads pre-built container images from a central lxc server. The most important use case is to allow simple creation of unprivileged containers by non-root users, who could not for instance easily run the `debootstrap` command.

When running `lxc-create`, all options which come after `-` are passed to the template. In the following command, `-name`, `-template` and `-bdev` are passed to `lxc-create`, while `-release` is passed to the template:

```
lxc-create --template ubuntu --name c1 --bdev loop -- --release DISTR0-SHORT-CODENAME
```

You can obtain help for the options supported by any particular container by passing `-help` and the template name to `lxc-create`. For instance, for help with the `download` template,

```
lxc-create --template download --help
```

## Autostart

LXC supports marking containers to be started at system boot. Prior to Ubuntu 14.04, this was done using symbolic links under the directory `/etc/lxc/auto`. Starting with Ubuntu 14.04, it is done through the container configuration files. An entry

```
lxc.start.auto = 1
lxc.start.delay = 5
```

would mean that the container should be started at boot, and the system should wait 5 seconds before starting the next container. LXC also supports ordering and grouping of containers, as well as reboot and shutdown by autostart groups. See the manual pages for `lxc-autostart` and `lxc.container.conf` for more information.

## Apparmor

LXC ships with a default Apparmor profile intended to protect the host from accidental misuses of privilege inside the container. For instance, the container will not be able to write to `/proc/sysrq-trigger` or to most `/sys` files.

The `usr.bin.lxc-start` profile is entered by running `lxc-start`. This profile mainly prevents `lxc-start` from mounting new filesystems outside of the container's root filesystem. Before executing the container's `init`, LXC requests a switch to the container's profile. By default, this profile is the `lxc-container-default` policy which is defined in `/etc/apparmor.d/lxc/lxc-default`. This profile prevents the container from accessing many dangerous paths, and from mounting most filesystems.

Programs in a container cannot be further confined - for instance, MySQL runs under the container profile (protecting the host) but will not be able to enter the MySQL profile (to protect the container).

`lxc-execute` does not enter an Apparmor profile, but the container it spawns will be confined.

### Customizing container policies

If you find that `lxc-start` is failing due to a legitimate access which is being denied by its Apparmor policy, you can disable the `lxc-start` profile by doing:

```
sudo apparmor_parser -R /etc/apparmor.d/usr.bin.lxc-start
sudo ln -s /etc/apparmor.d/usr.bin.lxc-start /etc/apparmor.d/disabled/
```

This will make `lxc-start` run unconfined, but continue to confine the container itself. If you also wish to disable confinement of the container, then in addition to disabling the `usr.bin.lxc-start` profile, you must add:

```
lxc.aa_profile = unconfined
```

to the container's configuration file.

LXC ships with a few alternate policies for containers. If you wish to run containers inside containers (nesting), then you can use the `lxc-container-default-with-nesting` profile by adding the following line to the container configuration file

```
lxc.aa_profile = lxc-container-default-with-nesting
```

If you wish to use `libvirt` inside containers, then you will need to edit that policy (which is defined in `/etc/apparmor.d/lxc/lxc-default-with-nesting`) by uncommenting the following line:

```
mount fstype=cgroup -> /sys/fs/cgroup/**,
```

and re-load the policy.

Note that the nesting policy with privileged containers is far less safe than the default policy, as it allows containers to re-mount `/sys` and `/proc` in nonstandard locations, bypassing apparmor protections. Unprivileged containers do not have this drawback since the container root cannot write to root-owned `proc` and `sys` files.

Another profile shipped with `lxc` allows containers to mount block filesystem types like `ext4`. This can be useful in some cases like `maas` provisioning, but is deemed generally unsafe since the superblock handlers in the kernel have not been audited for safe handling of untrusted input.

If you need to run a container in a custom profile, you can create a new profile under `/etc/apparmor.d/lxc/`. Its name must start with `lxc-` in order for `lxc-start` to be allowed to transition to that profile. The `lxc-default` profile includes the re-usable abstractions file `/etc/apparmor.d/abstractions/lxc/container-base`. An easy way to start a new profile therefore is to do the same, then add extra permissions at the bottom of your policy.

After creating the policy, load it using:

```
sudo apparmor_parser -r /etc/apparmor.d/lxc-containers
```

The profile will automatically be loaded after a reboot, because it is sourced by the file `/etc/apparmor.d/lxc-containers`. Finally, to make container `CN` use this new `lxc-CN-profile`, add the following line to its configuration file:

```
lxc.aa_profile = lxc-CN-profile
```

## Control Groups

Control groups (cgroups) are a kernel feature providing hierarchical task grouping and per-cgroup resource accounting and limits. They are used in containers to limit block and character device access and to freeze (suspend) containers. They can be further used to limit memory use and block i/o, guarantee minimum cpu shares, and to lock containers to specific cpus.

By default, a privileged container CN will be assigned to a cgroup called `/lxc/CN`. In the case of name conflicts (which can occur when using custom `lxcpaths`) a suffix “-n”, where n is an integer starting at 0, will be appended to the cgroup name.

By default, a privileged container CN will be assigned to a cgroup called CN under the cgroup of the task which started the container, for instance `/usr/1000.user/1.session/CN`. The container root will be given group ownership of the directory (but not all files) so that it is allowed to create new child cgroups.

As of Ubuntu 14.04, LXC uses the cgroup manager (`cgmanager`) to administer cgroups. The cgroup manager receives D-Bus requests over the Unix socket `/sys/fs/cgroup/cgmanager/sock`. To facilitate safe nested containers, the line

```
lxc.mount.auto = cgroup
```

can be added to the container configuration causing the `/sys/fs/cgroup/cgmanager` directory to be bind-mounted into the container. The container in turn should start the cgroup management proxy (done by default if the `cgmanager` package is installed in the container) which will move the `/sys/fs/cgroup/cgmanager` directory to `/sys/fs/cgroup/cgmanager.lower`, then start listening for requests to proxy on its own socket `/sys/fs/cgroup/cgmanager/sock`. The host `cgmanager` will ensure that nested containers cannot escape their assigned cgroups or make requests for which they are not authorized.

## Cloning

For rapid provisioning, you may wish to customize a canonical container according to your needs and then make multiple copies of it. This can be done with the `lxc-clone` program.

Clones are either snapshots or copies of another container. A copy is a new container copied from the original, and takes as much space on the host as the original. A snapshot exploits the underlying backing store’s snapshotting ability to make a copy-on-write container referencing the first. Snapshots can be created from `btrfs`, `LVM`, `zfs`, and directory backed containers. Each backing store has its own peculiarities - for instance, `LVM` containers which are not `thinpool`-provisioned cannot support snapshots of snapshots; `zfs` containers with snapshots cannot be removed until all snapshots are released; `LVM` containers must be more carefully planned as the underlying filesystem may not support growing; `btrfs` does not suffer any of these shortcomings, but suffers from reduced `fsync` performance causing `dpkg` and `apt` to be slower.

Snapshots of directory-packed containers are created using the overlay filesystem. For instance, a privileged directory-backed container C1 will have its root filesystem under `/var/lib/lxc/C1/rootfs`. A snapshot clone of C1 called C2 will be started with C1’s rootfs mounted readonly under `/var/lib/lxc/C2/delta0`. Importantly, in this case C1 should not be allowed to run or be removed while C2 is running. It is advised instead to consider C1 a *canonical* base container, and to only use its snapshots.

Given an existing container called C1, a copy can be created using:

```
sudo lxc-clone -o C1 -n C2
```

A snapshot can be created using:

```
sudo lxc-clone -s -o C1 -n C2
```

See the `lxc-clone` manpage for more information.

## Snapshots

To more easily support the use of snapshot clones for iterative container development, LXC supports *snapshots*. When working on a container C1, before making a potentially dangerous or hard-to-revert change, you can create a snapshot

```
sudo lxc-snapshot -n C1
```

which is a snapshot-clone called ‘snap0’ under `/var/lib/lxc/snaps` or `$HOME/.local/share/lxc/snaps`. The next snapshot will be called ‘snap1’, etc. Existing snapshots can be listed using `lxc-snapshot -L -n C1`, and a snapshot can be restored - erasing the current C1 container - using `lxc-snapshot -r snap1 -n C1`. After the restore command, the `snap1` snapshot continues to exist, and the previous C1 is erased and replaced with the `snap1` snapshot.

Snapshots are supported for `btrfs`, `lvm`, `zfs`, and `overlayfs` containers. If `lxc-snapshot` is called on a directory-backed container, an error will be logged and the snapshot will be created as a copy-clone. The reason for this is that if the user creates an `overlayfs` snapshot of a directory-backed container and then makes changes to the directory-backed container, then the original container changes will be partially reflected in the snapshot. If snapshots of a directory backed container C1 are desired, then an `overlayfs` clone of C1 should be created, C1 should not be touched again, and the `overlayfs` clone can be edited and snapshotted at will, as such

```
lxc-clone -s -o C1 -n C2
```

```
lxc-start -n C2 -d # make some changes
```

```
lxc-stop -n C2
lxc-snapshot -n C2
lxc-start -n C2 # etc
```

## Ephemeral Containers

While snapshots are useful for longer-term incremental development of images, ephemeral containers utilize snapshots for quick, single-use throwaway containers. Given a base container C1, you can start an ephemeral container using

```
lxc-start-ephemeral -o C1
```

The container begins as a snapshot of C1. Instructions for logging into the container will be printed to the console. After shutdown, the ephemeral container will be destroyed. See the `lxc-start-ephemeral` manual page for more options.

## Lifecycle management hooks

Beginning with Ubuntu 12.10, it is possible to define hooks to be executed at specific points in a container's lifetime:

- Pre-start hooks are run in the host's namespace before the container ttys, consoles, or mounts are up. If any mounts are done in this hook, they should be cleaned up in the post-stop hook.
- Pre-mount hooks are run in the container's namespaces, but before the root filesystem has been mounted. Mounts done in this hook will be automatically cleaned up when the container shuts down.
- Mount hooks are run after the container filesystems have been mounted, but before the container has called `pivot_root` to change its root filesystem.
- Start hooks are run immediately before executing the container's `init`. Since these are executed after pivoting into the container's filesystem, the command to be executed must be copied into the container's filesystem.
- Post-stop hooks are executed after the container has been shut down.

If any hook returns an error, the container's run will be aborted. Any *post-stop* hook will still be executed. Any output generated by the script will be logged at the debug priority.

Please see the `lxc.container.conf(5)` manual page for the configuration file format with which to specify hooks. Some sample hooks are shipped with the `lxc` package to serve as an example of how to write and use such hooks.

## Consoles

Containers have a configurable number of consoles. One always exists on the container's `/dev/console`. This is shown on the terminal from which you ran `lxc-start`, unless the `-d` option is specified. The output on `/dev/console` can be redirected to a file using the `-c console-file` option to `lxc-start`. The number of extra consoles is specified by the `lxc.tty` variable, and is usually set to 4. Those consoles are shown on `/dev/ttyN` (for  $1 \leq N \leq 4$ ). To log into console 3 from the host, use:

```
sudo lxc-console -n container -t 3
```

or if the `-t N` option is not specified, an unused console will be automatically chosen. To exit the console, use the escape sequence `Ctrl-a q`. Note that the escape sequence does not work in the console resulting from `lxc-start` without the `-d` option.

Each container console is actually a Unix98 pty in the host's (not the guest's) pty mount, bind-mounted over the guest's `/dev/ttyN` and `/dev/console`. Therefore, if the guest unmounts those or otherwise tries to access the actual character device `4:N`, it will not be serving getty to the LXC consoles. (With the default settings, the container will not be able to access that character device and getty will therefore fail.) This can easily happen when a boot script blindly mounts a new `/dev`.

## Troubleshooting

### Logging

If something goes wrong when starting a container, the first step should be to get full logging from LXC:

```
sudo lxc-start -n C1 -l trace -o debug.out
```

This will cause `lxc` to log at the most verbose level, `trace`, and to output log information to a file called 'debug.out'. If the file `debug.out` already exists, the new log information will be appended.

### Monitoring container status

Two commands are available to monitor container state changes. `lxc-monitor` monitors one or more containers for any state changes. It takes a container name as usual with the `-n` option, but in this case the container name can be a

posix regular expression to allow monitoring desirable sets of containers. `lxc-monitor` continues running as it prints container changes. `lxc-wait` waits for a specific state change and then exits. For instance,

```
sudo lxc-monitor -n cont[0-5]*
```

would print all state changes to any containers matching the listed regular expression, whereas

```
sudo lxc-wait -n cont1 -s 'STOPPED|FROZEN'
```

will wait until container `cont1` enters state `STOPPED` or state `FROZEN` and then exit.

## Attach

As of Ubuntu 14.04, it is possible to attach to a container's namespaces. The simplest case is to simply do

```
sudo lxc-attach -n C1
```

which will start a shell attached to `C1`'s namespaces, or, effectively inside the container. The attach functionality is very flexible, allowing attaching to a subset of the container's namespaces and security context. See the manual page for more information.

## Container init verbosity

If LXC completes the container startup, but the container init fails to complete (for instance, no login prompt is shown), it can be useful to request additional verbosity from the init process. For an upstart container, this might be:

```
sudo lxc-start -n C1 /sbin/init loglevel=debug
```

You can also start an entirely different program in place of `init`, for instance

```
sudo lxc-start -n C1 /bin/bash
```

```
sudo lxc-start -n C1 /bin/sleep 100
```

```
sudo lxc-start -n C1 /bin/cat /proc/1/status
```

## LXC API

Most of the LXC functionality can now be accessed through an API exported by `liblxc` for which bindings are available in several languages, including Python, lua, ruby, and go.

Below is an example using the python bindings (which are available in the `python3-lxc` package) which creates and starts a container, then waits until it has been shut down:

```
sudo python3
Python 3.2.3 (default, Aug 28 2012, 08:26:03)
[GCC 4.7.1 20120814 (prerelease)] on linux2
Type "help", "copyright", "credits" or "license" for more information.
>>> import lxc
__main__:1: Warning: The python-lxc API isn't yet stable and may change at any point in the future.
>>> c=lxc.Container("C1")
>>> c.create("ubuntu")
True
>>> c.start()
True
>>> c.wait("STOPPED")
True
```

## Security

A namespace maps ids to resources. By not providing a container any id with which to reference a resource, the resource can be protected. This is the basis of some of the security afforded to container users. For instance, IPC namespaces are completely isolated. Other namespaces, however, have various *leaks* which allow privilege to be inappropriately exerted from a container into another container or to the host.

By default, LXC containers are started under a Apparmor policy to restrict some actions. The details of AppArmor integration with `lxc` are in section *Apparmor*. Unprivileged containers go further by mapping root in the container to an unprivileged host UID. This prevents access to `/proc` and `/sys` files representing host resources, as well as any other files owned by root on the host.



## Exploitable system calls

It is a core container feature that containers share a kernel with the host. Therefore if the kernel contains any exploitable system calls the container can exploit these as well. Once the container controls the kernel it can fully control any resource known to the host.

In general to run a full distribution container a large number of system calls will be needed. However for application containers it may be possible to reduce the number of available system calls to only a few. Even for system containers running a full distribution security gains may be had, for instance by removing the 32-bit compatibility system calls in a 64-bit container. See the `lxc.container.conf` manual page for details of how to configure a container to use `seccomp`. By default, no `seccomp` policy is loaded.

## Resources

- The DeveloperWorks article [LXC: Linux container tools](#) was an early introduction to the use of containers.
- The [Secure Containers Cookbook](#) demonstrated the use of security modules to make containers more secure.
- The upstream LXC project is hosted at [linuxcontainers.org](http://linuxcontainers.org).

A definition of High Availability Clusters [from Wikipedia](#):

## High Availability Clusters

**High-availability clusters** (also known as **HA clusters** , **fail-over clusters** or **Metroclusters Active/Active** ) are groups of [computers](#) that support [server applications](#) that can be reliably utilized with a [minimum amount of down-time](#).

They operate by using [high availability software](#) to harness [redundant](#) computers in groups or [clusters](#) that provide continued service when system components fail.

Without clustering, if a server running a particular application crashes, the application will be unavailable until the crashed server is fixed. HA clustering remedies this situation by detecting hardware/software faults, and immediately restarting the application on another system without requiring administrative intervention, a process known as [failover](#).

As part of this process, clustering software may configure the node before starting the application on it. For example, appropriate file systems may need to be imported and mounted, network hardware may have to be configured, and some supporting applications may need to be running as well.

HA clusters are often used for critical [databases](#), file sharing on a network, business applications, and customer services such as [electronic commerce websites](#).

## High Availability Cluster Heartbeat

HA cluster implementations attempt to build redundancy into a cluster to eliminate single points of failure, including multiple network connections and data storage which is redundantly connected via [storage area networks](#).

HA clusters usually use a [heartbeat](#) private network connection which is used to monitor the health and status of each node in the cluster. One subtle but serious condition all clustering software must be able to handle is [split-brain](#), which occurs when all of the private links go down simultaneously, but the cluster nodes are still running.

If that happens, each node in the cluster may mistakenly decide that every other node has gone down and attempt to start services that other nodes are still running. Having duplicate instances of services may cause data corruption on the shared storage.

## High Availability Cluster Quorum

HA clusters often also use [quorum](#) witness storage (local or cloud) to avoid this scenario. A witness device cannot be shared between two halves of a split cluster, so in the event that all cluster members cannot communicate with each other (e.g., failed heartbeat), if a member cannot access the witness, it cannot become active.

## Example

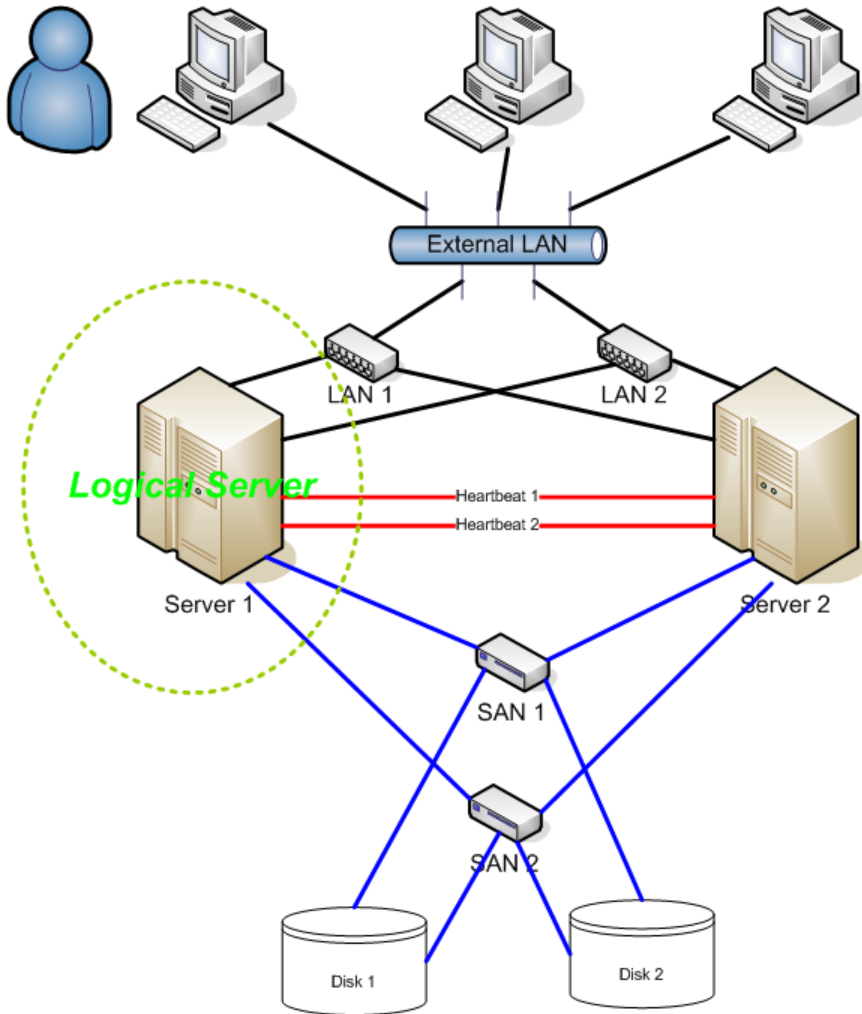

## Fencing

Fencing protects your data from being corrupted, and your application from becoming unavailable, due to unintended concurrent access by rogue nodes.

Just because a node is unresponsive doesn't mean it has stopped accessing your data. The only way to be 100% sure that your data is safe, is to use fencing to ensure that the node is truly offline before allowing the data to be accessed from another node.

Fencing also has a role to play in the event that a clustered service cannot be stopped. In this case, the cluster uses fencing to force the whole node offline, thereby making it safe to start the service elsewhere. The most popular example of fencing is cutting a host's power.

Key Benefits:

- Active countermeasure taken by a functioning host to isolate a misbehaving (usually dead) host from shared data.
- **MOST CRITICAL** part of a cluster utilizing SAN or other shared storage technology (*Ubuntu HA Clusters can only be supported if the fencing mechanism is configured*).
- Required by OCFS2, GFS2, cLVMd (before Ubuntu 20.04), lvmlockd (from 20.04 and beyond).

## Linux High Availability Projects

There are many upstream high availability related projects that are included in Ubuntu Linux. This section will describe the most important ones.

The following packages are present in latest Ubuntu LTS release:

### Ubuntu HA Core Packages

Packages in this list are supported just like any other package available in **[main] repository** would be.

Package	URL
libqb	<a href="#">Ubuntu</a>   <a href="#">Upstream</a>
kronosnet	<a href="#">Ubuntu</a>   <a href="#">Upstream</a>
corosync	<a href="#">Ubuntu</a>   <a href="#">Upstream</a>
pacemaker	<a href="#">Ubuntu</a>   <a href="#">Upstream</a>
resource-agents	<a href="#">Ubuntu</a>   <a href="#">Upstream</a>
fence-agents	<a href="#">Ubuntu</a>   <a href="#">Upstream</a>
crmsh	<a href="#">Ubuntu</a>   <a href="#">Upstream</a>
pcs*	<a href="#">Ubuntu</a>   <a href="#">Upstream</a>
cluster-glue	<a href="#">Ubuntu</a>   <a href="#">Upstream</a>
drbd-utils	<a href="#">Ubuntu</a>   <a href="#">Upstream</a>
dlm	<a href="#">Ubuntu</a>   <a href="#">Upstream</a>
gfs2-utils	<a href="#">Ubuntu</a>   <a href="#">Upstream</a>
keepalived	<a href="#">Ubuntu</a>   <a href="#">Upstream</a>

- **libqb** - Library which provides a set of high performance client-server reusable features. It offers high performance logging, tracing, IPC and poll. Its initial features were spun off the *Corosync* cluster communication suite to make them accessible for other projects.
- **Kronosnet** - Kronosnet, often referred to as *knet*, is a network abstraction layer designed for High Availability. Corosync uses Kronosnet to provide multiple networks for its interconnect (replacing the old [Totem Redundant Ring Protocol](#)) and add support for some more features like interconnect network hot-plug.
- **Corosync** - or *Cluster Membership Layer*, provides reliable messaging, membership and quorum information about the cluster. Currently, Pacemaker supports Corosync as this layer.
- **Pacemaker** - or *Cluster Resource Manager*, provides the brain that processes and reacts to events that occur in the cluster. Events might be: nodes joining or leaving the cluster, resource events caused by failures, maintenance, or scheduled activities. To achieve the desired availability, Pacemaker may start and stop resources and fence nodes.
- **Resource Agents** - Scripts or operating system components that start, stop or monitor resources, given a set of resource parameters. These provide a uniform interface between pacemaker and the managed services.
- **Fence Agents** - Scripts that execute node fencing actions, given a target and fence device parameters.
- **crmsh** - Advanced command-line interface for High-Availability cluster management in GNU/Linux.
- **pcs** - Pacemaker command line interface and GUI. It permits users to easily view, modify and create pacemaker based clusters. **pcs** also provides **pcsd**, which operates as a GUI and remote server for **pcs**. Together **pcs** and **pcsd** form the recommended configuration tool for use with pacemaker. *NOTE: It was added to the [main] repository in Ubuntu Lunar Lobster (23.10).*
- **cluster-glue** - Reusable cluster components for Linux HA. This package contains node fencing plugins, an error reporting utility, and other reusable cluster components from the Linux HA project.
- **DRBD** - Distributed Replicated Block Device, **DRBD** is a [distributed replicated storage system](#) for the Linuxplatform. It is implemented as a kernel driver, several userspace management applications, and some shell scripts. DRBD is traditionally used in high availability (HA) clusters.
- **DLM** - A distributed lock manager (DLM) runs in every machine in a cluster, with an identical copy of a cluster-wide lock database. In this way DLM provides software applications which are distributed across a cluster on multiple machines with a means to synchronize their accesses to shared resources.
- **gfs2-utils** - Global File System 2 - filesystem tools. The Global File System allows a cluster of machines to concurrently access shared storage hardware like SANs or iSCSI and network block devices.
- **Keepalived** - Keepalived provides simple and robust facilities for loadbalancing and high-availability to Linux system and Linux based infrastructures. Loadbalancing framework relies on well-known and widely used [Linux Virtual Server \(IPVS\)](#) kernel module providing Layer4 loadbalancing. Keepalived implements a set of checkers to dynamically and adaptively maintain and manage loadbalanced server pool according their health. On the other hand high-availability is achieved by [VRRP](#) protocol.

## Ubuntu HA Community Packages

Packages in this list are supported just like any other package available in [\[universe\]](#) repository would be.

Package	URL
pcs*	<a href="#">Ubuntu</a>   <a href="#">Upstream</a>
csync2	<a href="#">Ubuntu</a>   <a href="#">Upstream</a>
corosync-qdevice	<a href="#">Ubuntu</a>   <a href="#">Upstream</a>
fence-virt	<a href="#">Ubuntu</a>   <a href="#">Upstream</a>
sbd	<a href="#">Ubuntu</a>   <a href="#">Upstream</a>
booth	<a href="#">Ubuntu</a>   <a href="#">Upstream</a>

- **Corosync-Qdevice** - Its primary use is for even-node clusters, operates at corosync (quorum) layer. Corosync-Qdevice is an independent arbiter for solving split-brain situations. (qdevice-net supports multiple algorithms).
- **SBD** - A Fencing Block Device can be particularly useful in environments where traditional fencing mechanisms are not possible. SBD integrates with Pacemaker, a watchdog device and shared storage to arrange for nodes to reliably self-terminate when fencing is required.

Note: **pcs** was added to the [main] repository in Ubuntu Lunar Lobster (23.04).

### Ubuntu HA Deprecated Packages

Packages in this list are **only supported by the upstream community** . All bugs opened against these agents will be forwarded to upstream IF makes sense (affected version is close to upstream).

Package	URL
ocfs2-tools	<a href="#">Ubuntu</a>   <a href="#">Upstream</a>

### Ubuntu HA Related Packages

Packages in this list aren't necessarily **HA** related packages, but they have a very important role in High Availability Clusters and are supported like any other package provide by the [main] repository.

Package	URL
multipath-tools	<a href="#">Ubuntu</a>   <a href="#">Upstream</a>
open-iscsi	<a href="#">Ubuntu</a>   <a href="#">Upstream</a>
sg3-utils	<a href="#">Ubuntu</a>   <a href="#">Upstream</a>
tgt OR targetcli-fb*	<a href="#">Ubuntu</a>   <a href="#">Upstream</a>
lvm2	<a href="#">Ubuntu</a>   <a href="#">Upstream</a>

- **LVM2** in a Shared-Storage Cluster Scenario:

**CLVM** - supported before **Ubuntu 20.04**

A distributed lock manager (DLM) is used to broker concurrent LVM metadata accesses. Whenever a cluster node needs to modify the LVM metadata, it must secure permission from its local `clvmd` , which is in constant contact with other `clvmd` daemons in the cluster and can communicate a desire to get a lock on a particular set of objects.

**lvmlockd** - supported after **Ubuntu 20.04**

As of 2017, a stable LVM component that is designed to replace `clvmd` by making the locking of LVM objects transparent to the rest of LVM, without relying on a distributed lock manager.

The `lvmlockd` benefits over `clvm` are:

- `lvmlockd` supports two cluster locking plugins: DLM and SANLOCK. SANLOCK plugin can supports up to ~2000 nodes that benefits LVM usage in big virtualization / storage cluster, while DLM plugin fits HA cluster.
- `lvmlockd` has better design than `clvmd`. `clvmd` is command-line level based locking system, which means the whole LVM software will get hang if any LVM command gets dead-locking issue.
- `lvmlockd` can work with `lvmetad`.

Note: **targetcli-fb (Linux LIO)** will likely replace **tgt** in future Ubuntu versions.

## Upstream Documentation

The server guide does not have the intent to document every existing option for all the HA related softwares described in this page, but to document recommended scenarios for Ubuntu HA Clusters. You will find more complete documentation upstream at:

- ClusterLabs
  - [Clusters From Scratch](#)
  - [Managing Pacemaker Clusters](#)
  - [Pacemaker Configuration Explained](#)
  - [Pacemaker Remote - Scaling HA Clusters](#)
- Other
  - [Ubuntu Bionic HA in Shared Disk Environments \(Azure\)](#)

A very special thanks, and all the credits, to [ClusterLabs Project](#) for all that detailed documentation.

From the ClusterLabs definition:

Resource agents are the abstraction that allows Pacemaker to manage services it knows nothing about. They contain the logic for what to do when the cluster wishes to start, stop or check the health of a service. This particular set of agents conform to the Open Cluster Framework (OCF) specification.

At the moment, the `resource-agents` binary package has been split into two: `resource-agents-base` and `resource-agents-extra`. The `resource-agents-base` binary package contains a set of curated agents which the Ubuntu Server team continuously run tests to make sure everything is working as expected. All the other agents previously in the `resource-agents` binary package are now moved to the `resource-agents-extra`.

The `resource-agents-base` binary package contains the following agents in the latest Ubuntu release:

- `IPaddr2`
- `iscsi`
- `iSCSILogicalUnit`
- `iSCSITarget`
- `LVM-activate`
- `systemd`

All those agents are in `main` and are fully supported. The remaining agents are in `resource-agents-extra` and most of them are supported by upstream but they are not curated by the Ubuntu Server team. The set of resource agents that are not maintained by upstream is listed in `/usr/share/doc/resource-agents-extra/DEPRECATED_AGENTS`, the use of those agents is discouraged.

For the resource agents provided by `resource-agents-base`, we will be briefly describing how to use them.

### Note:

There are two well known tools used to manage fence agents, they are `crmsh` and `pcs`. Here we will present examples with both, since `crmsh` is the recommended and supported tool until Ubuntu 22.10 Kinetic Kudu, and `pcs` is the recommended and supported tool from Ubuntu 23.04 Lunar Lobster onwards. For more information on how to migrate from `crmsh` to `pcs` please [refer to this migration guide](#).

## IPaddr2

From its manpage:

This Linux-specific resource manages IP alias IP addresses. It can add an IP alias, or remove one. In addition, it can implement Cluster Alias IP functionality if invoked as a clone resource.

One could configure a `IPaddr2` resource with the following command:

```
$ crm configure primitive $RESOURCE_NAME ocf:heartbeat:IPaddr2 \
 ip=$IP_ADDRESS \
 cidr_netmask=$NET_MASK \
 op monitor interval=30s
```

One can do the same using `pcs` via the following command:

```
$ pcs resource create $RESOURCE_NAME ocf:heartbeat:IPaddr2 \
 ip=$IP_ADDRESS \
 cidr_netmask=$NET_MASK \
 op monitor interval=30s
```

This is one way to set up `IPaddr2`, for more information please check its manpage.

## iscsi

From its manpage:

Manages a local iSCSI initiator and its connections to iSCSI targets.

Once the iSCSI target is ready to accept connections from the initiator(s), with all the appropriate permissions, one could configure the `iscsi` resource with the following command:

```
$ crm configure primitive $RESOURCE_NAME ocf:heartbeat:iscsi \
 target=$TARGET \
 portal=$PORTAL
```

One can do the same using `pcs` via the following command:

```
$ pcs resource create $RESOURCE_NAME ocf:heartbeat:iscsi \
 target=$TARGET \
 portal=$PORTAL
```

Where `$TARGET` is the IQN (iSCSI Qualified Name) of the iSCSI target and `$PORTAL` its address, which can be, for instance, formed by the IP address and port number used by the target daemon.

This is one way to set up `iscsi`, for more information please check its manpage.

## iSCSILogicalUnit

From its manpage:

Manages iSCSI Logical Unit. An iSCSI Logical unit is a subdivision of an SCSI Target, exported via a daemon that speaks the iSCSI protocol.

This agent is usually used alongside with `iSCSITarget` to manage the target itself and its Logical Units. The supported implementation of iSCSI targets is using `targetcli-fb`, due to that, make sure to use `lio-t` as the implementation type. Considering one has an iSCSI target in place, the `iSCSILogicalUnit` resource could be configured with the following command:

```
$ crm configure primitive $RESOURCE_NAME ocf:heartbeat:iSCSILogicalUnit \
 implementation=lio-t \
 target_iqn=$IQN_TARGET \
 path=$DEVICE \
 lun=$LUN
```

One can do the same using `pcs` via the following command:

```
$ pcs resource create $RESOURCE_NAME ocf:heartbeat:iSCSILogicalUnit \
 implementation=lio-t \
 target_iqn=$IQN_TARGET \
 path=$DEVICE \
 lun=$LUN
```

Where implementation is set to `lio-t` as mentioned before, `$IQN_TARGET` is the IQN (iSCSI Qualified Name) that this Logical Unit belongs to, `$DEVICE` is the path to the exposed block device, and `$LUN` is the number representing the Logical Unit which will be exposed to initiators.

This is one way to set up `iSCSILogicalUnit`, for more information please check its manpage.

## iSCSITarget

From its manpage:

Manages iSCSI targets. An iSCSI target is a collection of SCSI Logical Units (LUs) exported via a daemon that speaks the iSCSI protocol.

This agent is usually used alongside with `iSCSILogicalUnit` to manage the target itself and its Logical Units. The supported implementation of iSCSI targets is using `targetcli-fb`, due to that, make sure to use `lio-t` as the implementation type. Considering one has `targetcli-fb` installed on the system, the `iSCSITarget` resource could be configured with the following command:

```
$ crm configure primitive $RESOURCE_NAME ocf:heartbeat:iSCSITarget \
 implementation=lio-t \
 iqn=$IQN_TARGET
```

One can do the same using `pcs` via the following command:

```
$ pcs resource create $RESOURCE_NAME ocf:heartbeat:iSCSITarget \
 implementation=lio-t \
 iqn=$IQN_TARGET
```

Where implementation is set to `lio-t` as mentioned before and `$IQN_TARGET` is the IQN (iSCSI Qualified Name) of the target.

This is one way to set up `iSCSITarget`, for more information please check its manpage.

## LVM-activate

From its manpage:

This agent manages LVM activation/deactivation work for a given volume group.

Considering the LVM setup is ready to be activated and deactivated by this resource agent (make sure the `system_id_resource` is set to `uname` in `/etc/lvm/lvm.conf`), one could configure a `LVM-activate` resource with the following command:

```
$ crm configure primitive $RESOURCE_NAME ocf:heartbeat:LVM-activate \
 vgname=$VOLUME_GROUP \
 vg_access_mode=system_id
```

One can do the same using `pcs` via the following command:

```
$ pcs resource create $RESOURCE_NAME ocf:heartbeat:LVM-activate \
 vgname=$VOLUME_GROUP \
 vg_access_mode=system_id
```

This is one way to set up `LVM-activate`, for more information please check its manpage.

## Systemd

There is also a way to manage `systemd` unit files via a resource agent. One need to have the `systemd` unit file in place (already loaded by `systemd`) and configure a resource using the following command:

```
$ crm configure primitive $RESOURCE_NAME systemd:$SERVICE_NAME
```

One can do the same using `pcs` via the following command:

```
$ pcs resource create $RESOURCE_NAME systemd:$SERVICE_NAME
```

The `$SERVICE_NAME` can be any service managed by a `systemd` unit file, and it needs to be available for the cluster nodes.

## References

- [ClusterLabs website](#)
- [The OCF resource-agent developer's guide](#)
- [Users mailing list](#)

From the ClusterLabs definition:

A *fence agent* (or *fencing agent*) is a **stonith**-class resource agent.

The fence agent standard provides commands (such as `off` and `reboot`) that the cluster can use to fence nodes. As with other resource agent classes, this allows a layer of abstraction so that Pacemaker doesn't need any knowledge about specific fencing technologies — that knowledge is isolated in the agent.

At the moment, the `fence-agents` binary package has been split into two: `fence-agents-base` and `fence-agents-extra`. The `fence-agents-base` binary package contains a set of curated agents which the Ubuntu Server team continuously run tests to make sure everything is working as expected. All the other agents previously in the `fence-agents` binary package are now moved to the `fence-agents-extra`.

The `fence-agents-base` binary package contains the following agents in the latest Ubuntu release:

- `fence_ipmilan`
  - `fence_idrac`
  - `fence_ilo3`
  - `fence_ilo4`
  - `fence_ilo5`
  - `fence_imm`

- fence\_ipmilanplus
- fence\_mpath
- fence\_sbd
- fence\_scsi
- fence\_virsh

All those agents are in `main` and are fully supported. The remaining agents in `fence-agents-extra` are supported by upstream but they are not curated by the Ubuntu Server team.

For the fence agents provided by `fence-agents-base`, we will be briefly describing how to use them.

**Note:**

There are two well known tools used to manage fence agents, they are `crmsh` and `pcs`. Here we will present examples with both, since `crmsh` is the recommended and supported tool until Ubuntu 22.10 Kinetic Kudu, and `pcs` is the recommended and supported tool from Ubuntu 23.04 Lunar Lobster onwards. For more information on how to migrate from `crmsh` to `pcs` please [refer to this migration guide](#).

## fence\_ipmilan

The content of this section is also applicable to the following fence agents: `fence_idrac`, `fence_ilo3`, `fence_ilo4`, `fence_ilo5`, `fence_imm`, and `fence_ipmilanplus`. All of them are symlinks to `fence_ipmilan`.

From its manpage:

`fence_ipmilan` is an I/O Fencing agent which can be used with machines controlled by IPMI. This agent calls support software `ipmitool`. **WARNING!** This fence agent might report success before the node is powered off. You should use `-m/method onoff` if your fence device works correctly with that option.

In a system which supports IPMI and with `ipmitool` installed, one could configure a `fence_ipmilan` resource with the following command:

```
$ crm configure primitive $RESOURCE_NAME stonith:fence_ipmilan \
 ip=$IP \
 ipport=$PORT \
 username=$USER \
 password=$PASSWD \
 lanplus=1 \
 action=$ACTION
```

One can do the same using `pcs` via the following command:

```
$ pcs stonith create $RESOURCE_NAME fence_ipmilan \
 ip=$IP \
 ipport=$PORT \
 username=$USER \
 password=$PASSWD \
 lanplus=1 \
 action=$ACTION
```

Where `$IP` is the IP address or hostname of fencing device, `$PORT` is the TCP/UDP port to use for connection, `$USER` is the login name and `$PASSWD` its password, and `$ACTION` is the fencing actions which by default is `reboot`.

This is one way to set up `fence_ipmilan`, for more information please check its manpage.

## fence\_mpath

From its manpage:

`fence_mpath` is an I/O fencing agent that uses SCSI-3 persistent reservations to control access multipath devices. Underlying devices must support SCSI-3 persistent reservations (SPC-3 or greater) as well as the “preempt-and-abort” subcommand. The `fence_mpath` agent works by having a unique key for each node that has to be set in `/etc/multipath.conf`. Once registered, a single node will become the reservation holder by creating a “write exclusive, registrants only” reservation on the device(s). The result is that only registered nodes may write to the device(s). When a node failure occurs, the `fence_mpath` agent will remove the key belonging to the failed node from the device(s). The failed node will no longer be able to write to the device(s). A manual reboot is required.

One could configure a `fence_mpath` resource with the following command:



```
$ crm configure primitive $RESOURCE_NAME stonith:fence_mpath \
 pcmk_host_map="$NODE1:$NODE1_RES_KEY;$NODE2:$NODE2_RES_KEY;$NODE3:$NODE3_RES_KEY" \
 pcmk_host_argument=key \
 pcmk_monitor_action=metadata \
 pcmk_reboot_action=off \
 devices=$MPATH_DEVICE \
 meta provides=unfencing
```

One can do the same using pcs via the following command:

```
$ pcs stonith create $RESOURCE_NAME fence_mpath \
 pcmk_host_map="$NODE1:$NODE1_RES_KEY;$NODE2:$NODE2_RES_KEY;$NODE3:$NODE3_RES_KEY" \
 pcmk_host_argument=key \
 pcmk_monitor_action=metadata \
 pcmk_reboot_action=off \
 devices=$MPATH_DEVICE \
 meta provides=unfencing
```

The `$NODE1_RES_KEY` is the reservation key used by this node 1 (same for the others node with access to the multipath device), please make sure you have `reservation_key <key>` in the `default` section inside `/etc/multipath.conf` and the `multipathd` service was reloaded after it.

This is one way to set up `fence_mpath`, for more information please check its manpage.

## fence\_\_sbd

From its manpage:

`fence_sbd` is I/O Fencing agent which can be used in environments where `sbd` can be used (shared storage).

With SBD (STONITH Block Device) configured on a system, one could configure the `fence_sbd` resource with the following command:

```
$ crm configure primitive $RESOURCE_NAME stonith:fence_sbd devices=$DEVICE
```

One can do the same using pcs via the following command:

```
$ pcs stonith create $RESOURCE_NAME fence_sbd devices=$DEVICE
```

This is one way to set up `fence_sbd`, for more information please check its manpage.

## fence\_\_scsi

From its manpage:

`fence_scsi` is an I/O fencing agent that uses SCSI-3 persistent reservations to control access to shared storage devices. These devices must support SCSI-3 persistent reservations (SPC-3 or greater) as well as the “preempt-and-abort” subcommand. The `fence_scsi` agent works by having each node in the cluster register a unique key with the SCSI device(s). Reservation key is generated from “node id” (default) or from “node name hash” (RECOMMENDED) by adjusting “key\_value” option. Using hash is recommended to prevent issues when removing nodes from cluster without full cluster restart. Once registered, a single node will become the reservation holder by creating a “write exclusive, registrants only” reservation on the device(s). The result is that only registered nodes may write to the device(s). When a node failure occurs, the `fence_scsi` agent will remove the key belonging to the failed node from the device(s). The failed node will no longer be able to write to the device(s). A manual reboot is required.

One could configure a `fence_scsi` resource with the following command:

```
$ crm configure primitive $RESOURCE_NAME stonith:fence_scsi \
 pcmk_host_list="$NODE1 $NODE2 $NODE3" \
 devices=$SCSI_DEVICE \
 meta provides=unfencing
```

One can do the same using pcs via the following command:

```
$ pcs stonith create $RESOURCE_NAME fence_scsi \
 pcmk_host_list="$NODE1 $NODE2 $NODE3" \
 devices=$SCSI_DEVICE \
 meta provides=unfencing
```

The `pcmk_host_list` parameter contains a list of cluster nodes that can access the managed SCSI device.

This is one way to set up `fence_scsi`, for more information please check its manpage.

## fence\_virsh

From its manpage:

`fence_virsh` is an I/O Fencing agent which can be used with the virtual machines managed by libvirt. It logs via ssh to a dom0 and there run `virsh` command, which does all work. By default, `virsh` needs root account to do properly work. So you must allow ssh login in your `sshd_config`.

One could configure a `fence_virsh` resource with the following command:

```
$ crm configure primitive $RESOURCE_NAME stonith:fence_virsh \
 ip=$HOST_IP_ADDRESS \
 login=$HOST_USER \
 identity_file=$SSH_KEY \
 plug=$NODE \
 ssh=true \
 use_sudo=true
```

One can do the same using `pcs` via the following command:

```
$ pcs stonith create $RESOURCE_NAME fence_virsh \
 ip=$HOST_IP_ADDRESS \
 login=$HOST_USER \
 identity_file=$SSH_KEY \
 plug=$NODE \
 ssh=true \
 use_sudo=true
```

This is one way to set up `fence_virsh`, for more information please check its manpage.

In order to avoid running the resource in the same node that should be fenced, we need to add a location restriction:

```
$ crm configure location fence-$NODE-location $RESOURCE_NAME -inf: $NODE
```

Using `pcs`:

```
$ pcs constraint location $RESOURCE_NAME avoids $NODE
```

## References

- [ClusterLabs website](#)
- [Fence agents API documentation](#)
- [Users mailing list](#)

Distributed Replicated Block Device (DRBD) mirrors block devices between multiple hosts. The replication is transparent to other applications on the host systems. Any block device hard disks, partitions, RAID devices, logical volumes, etc can be mirrored.

To get started using `drbd`, first install the necessary packages. From a terminal enter:

```
sudo apt install drbd-utils
```

### Note

If you are using the *virtual kernel* as part of a virtual machine you will need to manually compile the `drbd` module. It may be easier to install the `linux-server` package inside the virtual machine.

This section covers setting up a `drbd` to replicate a separate `/srv` partition, with an `ext3` filesystem between two hosts. The partition size is not particularly relevant, but both partitions need to be the same size.

## Configuration

The two hosts in this example will be called `drbd01` and `drbd02`. They will need to have name resolution configured either through DNS or the `/etc/hosts` file. See ??? for details.

- To configure `drbd`, on the first host edit `/etc/drbd.conf`:

```

global { usage-count no; }
common { syncer { rate 100M; } }
resource r0 {
 protocol C;
 startup {
 wfc-timeout 15;
 degr-wfc-timeout 60;
 }
 net {
 cram-hmac-alg sha1;
 shared-secret "secret";
 }
 on drbd01 {
 device /dev/drbd0;
 disk /dev/sdb1;
 address 192.168.0.1:7788;
 meta-disk internal;
 }
 on drbd02 {
 device /dev/drbd0;
 disk /dev/sdb1;
 address 192.168.0.2:7788;
 meta-disk internal;
 }
}

```

### Note

There are many other options in `/etc/drbd.conf`, but for this example their default values are fine.

- Now copy `/etc/drbd.conf` to the second host:

```
scp /etc/drbd.conf drbd02:~
```

- And, on `drbd02` move the file to `/etc`:

```
sudo mv drbd.conf /etc/
```

- Now using the `drbdadm` utility initialize the meta data storage. On each server execute:

```
sudo drbdadm create-md r0
```

- Next, on both hosts, start the `drbd` daemon:

```
sudo systemctl start drbd.service
```

- On the `drbd01`, or whichever host you wish to be the primary, enter the following:

```
sudo drbdadm -- --overwrite-data-of-peer primary all
```

- After executing the above command, the data will start syncing with the secondary host. To watch the progress, on `drbd02` enter the following:

```
watch -n1 cat /proc/drbd
```

To stop watching the output press `Ctrl+c`.

- Finally, add a filesystem to `/dev/drbd0` and mount it:

```
sudo mkfs.ext3 /dev/drbd0
sudo mount /dev/drbd0 /srv
```

## Testing

To test that the data is actually syncing between the hosts copy some files on the `drbd01`, the primary, to `/srv`:

```
sudo cp -r /etc/default /srv
```

Next, unmount `/srv`:

```
sudo umount /srv
```

Demote the *primary* server to the *secondary* role:

```
sudo drbdadm secondary r0
```

Now on the *secondary* server *promote* it to the *primary* role:

```
sudo drbdadm primary r0
```

Lastly, mount the partition:

```
sudo mount /dev/drbd0 /srv
```

Using *ls* you should see */srv/default* copied from the former *primary* host *drbd01*.

## References

- For more information on DRBD see the [DRBD web site](#).
- The [drbd.conf man page](#) contains details on the options not covered in this guide.
- Also, see the [drbdadm man page](#).
- The [DRBD Ubuntu Wiki](#) page also has more information.

From Ubuntu 23.04 Lunar Lobster onwards *pcs* is the recommended and supported tool to set up and manage Corosync/Pacemaker clusters in Ubuntu. This is the last Ubuntu release where *crmsh* will be supported, but not recommended, so users will have time to migrate out of it.

The migration from *crmsh* to *pcs* is not that complex since both have a similar CLI. Below one can find a direct mapping of some useful commands from *crmsh* to *pcs*.

Action	crmsh
Show configuration (raw XML)	<i>crm configure show xml</i>
Show configuration (human-friendly)	<i>crm configure show</i>
Show cluster status	<i>crm status</i>
Put a node in standby mode	<i>crm node standby NODE</i>
Remove a node from standby mode	<i>crm node online NODE</i>
Set cluster property	<i>crm configure property PROPERTY=VALUE</i>
List Resource Agent classes	<i>crm ra classes</i>
List available Resource Agents by standard	<i>crm ra list ocf</i>
List available Resource Agents by OCF provider	<i>crm ra list ocf pacemaker</i>
List available Resource Agent parameters	<i>crm ra info AGENT</i>
Show available Fence Agent parameters	<i>crm ra info stonith:AGENT</i>
Create a resource	<i>crm configure primitive NAME AGENT params PARAMETERS</i>
Show configuration of all resources	<i>crm configure show</i>
Show configuration of one resource	<i>crm configure show RESOURCE</i>
Show configuration of fencing resources	<i>crm resource status</i>
Start a resource	<i>crm resource start RESOURCE</i>
Stop a resource	<i>crm resource stop RESOURCE</i>
Remove a resource	<i>crm configure delete RESOURCE</i>
Modify a resource's instance parameters	<i>crm resource param RESOURCE set PARAMETER=VALUE</i>
Delete a resource's instance parameters	<i>crm resource param RESOURCE delete PARAMETER</i>
List current resource defaults	<i>crm configure show type:rsc_defaults</i>
Set resource defaults	<i>crm configure rsc_defaults OPTION=VALUE</i>
List current operation defaults	<i>crm configure show type:op_defaults</i>
Set operation defaults	<i>crm configure op_defaults OPTION=VALUE</i>
Clear fail counts for a resource	<i>crm resource cleanup RESOURCE</i>
Create a colocation constraint	<i>crm configure colocation NAME INFINITY: RESOURCE_1 RESOURCE_2</i>
Create an ordering constraint	<i>crm configure order NAME mandatory: RESOURCE_1 RESOURCE_2</i>
Create a location constraint	<i>crm configure location NAME RESOURCE 50: NODE</i>
Move a resource to a specific node	<i>crm resource move RESOURCE NODE</i>
Move a resource away from its current node	<i>crm resource ban RESOURCE NODE</i>
Remove any constraints created by moving a resource	<i>crm resource unmove RESOURCE</i>

Ubuntu provides two popular database servers. They are:

- [MySQL](#)
- [PostgreSQL](#)

Both are popular choices among developers, with similar feature sets and performance capabilities. Historically,

Postgres tended to be a preferred choice for its attention to standards conformance, features, and extensibility, whereas MySQL may be more preferred for higher performance requirements. However, over time each has made good strides catching up with the other. Specialised needs may make one a better option for a certain application, but in general both are good, strong options.

They are available in the Main repository and equally supported by Ubuntu. This section explains how to install and configure these database servers.

[MySQL](#) is a fast, multi-threaded, multi-user, and robust SQL database server. It is intended for mission-critical, heavy-load production systems and mass-deployed software.

## Installation

To install MySQL, run the following command from a terminal prompt:

```
sudo apt install mysql-server
```

Once the installation is complete, the MySQL server should be started automatically. You can quickly check its current status via `systemd`:

```
sudo service mysql status
```

Which should provide an output like the following:

```
● mysql.service - MySQL Community Server
 Loaded: loaded (/lib/systemd/system/mysql.service; enabled; vendor preset: enabled)
 Active: active (running) since Tue 2019-10-08 14:37:38 PDT; 2 weeks 5 days ago
 Main PID: 2028 (mysqld)
 Tasks: 28 (limit: 4915)
 CGroup: /system.slice/mysql.service
 └─2028 /usr/sbin/mysqld --daemonize --pid-file=/run/mysqld/mysqld.pid
 Oct 08 14:37:36 db.example.org systemd[1]: Starting MySQL Community Server...
 Oct 08 14:37:38 db.example.org systemd[1]: Started MySQL Community Server.
```

The network status of the MySQL service can also be checked by running the `ss` command at the terminal prompt:

```
sudo ss -tap | grep mysql
```

When you run this command, you should see something similar to the following:

```
LISTEN 0 151 127.0.0.1:mysql 0.0.0.0:* users:(("mysqld",pid=149190,fd=29))
LISTEN 0 70 *:33060 *:* users:(("mysqld",pid=149190,fd=32))
```

If the server is not running correctly, you can type the following command to start it:

```
sudo service mysql restart
```

A good starting point for troubleshooting problems is the `systemd` journal, which can be accessed from the terminal prompt with this command:

```
sudo journalctl -u mysql
```

## Configuration

You can edit the files in `/etc/mysql/` to configure the basic settings – log file, port number, etc. For example, to configure MySQL to listen for connections from network hosts, in the file `/etc/mysql/mysql.conf.d/mysqld.cnf`, change the `bind-address` directive to the server's IP address:

```
bind-address = 192.168.0.5
```

### Note:

Replace `192.168.0.5` with the appropriate address, which can be determined via the `ip address show` command.

After making a configuration change, the MySQL daemon will need to be restarted with the following command:

```
sudo systemctl restart mysql.service
```

## Database engines

Whilst the default configuration of MySQL provided by the Ubuntu packages is perfectly functional and performs well there are things you may wish to consider before you proceed.

MySQL is designed to allow data to be stored in different ways. These methods are referred to as either database or storage engines. There are two main storage engines that you'll be interested in: [InnoDB](#) and [MyISAM](#). Storage engines are transparent to the end user. MySQL will handle things differently under the surface, but regardless of which storage engine is in use, you will interact with the database in the same way.

Each engine has its own advantages and disadvantages.

While it is possible (and may be advantageous) to mix and match database engines on a table level, doing so reduces the effectiveness of the performance tuning you can do as you'll be splitting the resources between two engines instead of dedicating them to one.

- MyISAM is the older of the two. It can be faster than InnoDB under certain circumstances and favours a read-only workload. Some web applications have been tuned around MyISAM (though that's not to imply that they will be slower under InnoDB). MyISAM also supports the FULLTEXT data type, which allows very fast searches of large quantities of text data. However MyISAM is only capable of locking an entire table for writing. This means only one process can update a table at a time. As any application that uses the table scales this may prove to be a hindrance. It also lacks journaling, which makes it harder for data to be recovered after a crash. The following link provides some points for consideration about using [MyISAM on a production database](#).
- InnoDB is a more modern database engine, designed to be [ACID compliant](#) which guarantees database transactions are processed reliably. Write locking can occur on a row level basis within a table. That means multiple updates can occur on a single table simultaneously. Data caching is also handled in memory within the database engine, allowing caching on a more efficient row level basis rather than file block. To meet ACID compliance all transactions are journaled independently of the main tables. This allows for much more reliable data recovery as data consistency can be checked.

As of MySQL 5.5 InnoDB is the default engine, and is highly recommended over MyISAM unless you have specific needs for features unique to that engine.

## Advanced configuration

### Creating a tuned configuration

There are a number of parameters that can be adjusted within MySQL's configuration files. This will allow you to improve the server's performance over time.

Many parameters can be adjusted with the existing database, however some may affect the data layout and thus need more care to apply.

First, if you have existing data, you will first need to carry out a `mysqldump` and reload:

```
mysqldump --all-databases --routines -u root -p > ~/fulldump.sql
```

This will then prompt you for the root password before creating a copy of the data. It is advisable to make sure there are no other users or processes using the database whilst this takes place. Depending on how much data you've got in your database, this may take a while. You won't see anything on the screen during this process.

Once the dump has been completed, shut down MySQL:

```
sudo service mysql stop
```

It's also a good idea to backup the original configuration:

```
sudo rsync -avz /etc/mysql /root/mysql-backup
```

Next, make any desired configuration changes. Then, delete and re-initialise the database space and make sure ownership is correct before restarting MySQL:

```
sudo rm -rf /var/lib/mysql/*
sudo mysqld --initialize
sudo chown -R mysql: /var/lib/mysql
sudo service mysql start
```

The final step is re-importation of your data by piping your SQL commands to the database.

```
cat ~/fulldump.sql | mysql
```

For large data imports, the 'Pipe Viewer' utility can be useful to track import progress. Ignore any ETA times produced by `pv`; they're based on the average time taken to handle each row of the file, but the speed of inserting can vary wildly from row to row with `mysqldumps`:

```
sudo apt install pv
pv ~/fulldump.sql | mysql
```

Once this step is complete, you are good to go!

**Note:**

This is not necessary for all `my.cnf` changes. Most of the variables you can change to improve performance are adjustable even whilst the server is running. As with anything, make sure to have a good backup copy of your config files and data before making changes.

## MySQL Tuner

[MySQL Tuner](#) is a Perl script that connects to a running MySQL instance and offers configuration suggestions for optimising the database for your workload. The longer the server has been running, the better the advice `mysqLTuner` can provide. In a production environment, consider waiting for at least 24 hours before running the tool. You can install `mysqLTuner` from the Ubuntu repositories:

```
sudo apt install mysqLTuner
```

Then once it has been installed, simply run: `mysqLTuner` – and wait for its final report.

The top section provides general information about the database server, and the bottom section provides tuning suggestions to alter in your `my.cnf`. Most of these can be altered live on the server without restarting; look through the official MySQL documentation (link in Resources section at the bottom of this page) for the relevant variables to change in production. The following example is part of a report from a production database showing potential benefits from increasing the query cache:

```
----- Recommendations -----
General recommendations:
 Run OPTIMIZE TABLE to defragment tables for better performance
 Increase table_cache gradually to avoid file descriptor limits
Variables to adjust:
 key_buffer_size (> 1.4G)
 query_cache_size (> 32M)
 table_cache (> 64)
 innodb_buffer_pool_size (>= 22G)
```

It goes without saying that performance optimisation strategies vary from application to application. So for example, what works best for WordPress might not be the best for Drupal or Joomla. Performance can be dependent on the types of queries, use of indexes, how efficient the database design is and so on.

You may find it useful to spend some time searching for database tuning tips based on what applications you're using. Once you've reached the point of diminishing returns from database configuration adjustments, look to the application itself for improvements, or invest in more powerful hardware and/or scaling up the database environment.

## Resources

- Full documentation is available in both online and offline formats from the [MySQL Developers portal](#)
- For general SQL information see the O'Reilly books [Getting Started with SQL: A Hands-On Approach for Beginners](#) by Thomas Nield as an entry point and [SQL in a Nutshell](#) as a quick reference.
- The [Apache MySQL PHP Ubuntu Wiki](#) page also has useful information.

[PostgreSQL](#) (also known as Postgres) is an object-relational database system that has the features of traditional commercial database systems with enhancements to be found in next-generation database management systems (DBMS).

## Installation

To install PostgreSQL, run the following command in the command prompt:

```
sudo apt install postgresql
```

The database service is automatically configured with viable defaults, but can be customised based on your specific needs.

## Configuration

PostgreSQL supports multiple client authentication methods. In Ubuntu, `peer` is the default authentication method used for local connections, while `scram-sha-256` is the default for host connections (this used to be `md5` until Ubuntu 21.10). Please refer to the [PostgreSQL Administrator's Guide](#) if you would like to configure alternatives like Kerberos.

The following discussion assumes that you wish to enable TCP/IP connections and use the MD5 method for client authentication. PostgreSQL configuration files are stored in the `/etc/postgresql/<version>/main` directory. For example, if you install PostgreSQL 14, the configuration files are stored in the `/etc/postgresql/14/main` directory.

**Tip:**

To configure *IDENT* authentication, add entries to the `/etc/postgresql/*/main/pg_ident.conf` file. There are detailed comments in the file to guide you.

By default only connections from the local system are allowed, to enable all other computers to connect to your PostgreSQL server, edit the file `/etc/postgresql/*/main/postgresql.conf`. Locate the line: `#listen_addresses = 'localhost'` and change it to `*`:

```
listen_addresses = '*'
```

**Note:**

`*` will allow all available IP interfaces (IPv4 and IPv6), to only listen for IPv4 set `'0.0.0.0'` while `:::` allows listening for all IPv6 addresses.

For details on other parameters, refer to the configuration file or to the [PostgreSQL documentation](#) for information on how they can be edited.

Now that we can connect to our PostgreSQL server, the next step is to set a password for the *postgres* user. Run the following command at a terminal prompt to connect to the default PostgreSQL template database:

```
sudo -u postgres psql template1
```

The above command connects to PostgreSQL database *template1* as user *postgres*. Once you connect to the PostgreSQL server, you will be at an SQL prompt. You can run the following SQL command at the `psql` prompt to configure the password for the user *postgres*.

```
ALTER USER postgres with encrypted password 'your_password';
```

After configuring the password, edit the file `/etc/postgresql/*/main/pg_hba.conf` to use *scram-sha-256* authentication with the *postgres* user, allowed for the *template1* database, from any system in the local network (which in the example is `192.168.122.1/24`) :

```
hostssl template1 postgres 192.168.122.1/24 scram-sha-256
```

**Note:**

The config statement `'hostssl'` used here will reject tcp connections that would not use ssl. PostgreSQL in Ubuntu has the ssl feature built in and configured by default, so it works right away. On your postgresql server this uses the certificate created by `'ssl-cert'` package which is great, but for production use you should consider updating that with a proper certificate from a recognized CA.

Finally, you should restart the PostgreSQL service to initialise the new configuration. From a terminal prompt enter the following to restart PostgreSQL:

```
sudo systemctl restart postgresql.service
```

**Warning:**

The above configuration is not complete by any means. Please refer to the [PostgreSQL Administrator's Guide](#) to configure more parameters.

You can test server connections from other machines by using the PostgreSQL client as follows, replacing the domain name with your actual server domain name or IP address:

```
sudo apt install postgresql-client
psql --host your-servers-dns-or-ip --username postgres --password --dbname template1
```

## Streaming replication

PostgreSQL has a nice feature called Streaming Replication which provides the capability to continuously ship and apply the Write-Ahead Log (WAL) XLOG records to some number of standby servers in order to keep them current. Here is presented a very basic and simple way to replicate a PostgreSQL server (main) to a standby server.

First, create a replication user in the main server to be used from the standby server:

```
sudo -u postgres createuser --replication -P -e replicator
```

Let's configure the main server to turn on the streaming replication. Open the file `/etc/postgresql/*/main/postgresql.conf` and make sure you have the following lines:

```
listen_addresses = '*'
wal_level = replica
```



Also edit the file `/etc/postgresql/*/main/pg_hba.conf` to add an extra line to allow the standby server connection for replication (that is a special keyword) using the replicator user:

```
host replication replicator <IP address of the standby> scram-sha-256
```

Restart the service to apply changes:

```
sudo systemctl restart postgresql
```

Now, in the standby server, let's stop the PostgreSQL service:

```
sudo systemctl stop postgresql
```

Edit the `/etc/postgresql/*/main/postgresql.conf` to set up hot standby:

```
hot_standby = on
```

Back up the current state of the main server (those commands are still issued on the standby system):

```
sudo su - postgres
backup the current content of the standby server (update the version of your postgres accordingly)
cp -R /var/lib/postgresql/14/main /var/lib/postgresql/14/main_bak
remove all the files in the data directory
rm -rf /var/lib/postgresql/14/main/*
pg_basebackup -h <IP address of the main server> -D /var/lib/postgresql/14/main -U replicator -P -v -R
```

After the above this will have done a full single pass copying the content of the main database onto the local system being the standby. In the `pg_basebackup` command the flags represent the following:

- `-h`: The hostname or IP address of the main server
- `-D`: The data directory
- `-U`: The user to be used in the operation
- `-P`: Turns on progress reporting
- `-v`: Enables verbose mode
- `-R`: Creates a `standby.signal` file and appends connection settings to `postgresql.auto.conf`

Finally, let's start the PostgreSQL service on standby server:

```
sudo systemctl start postgresql
```

To make sure it is working, go to the main server and run the following command:

```
sudo -u postgres psql -c "select * from pg_stat_replication;"
```

As mentioned, this is a very simple introduction, there are way more great details in the upstream documentation about the configuration of [replication](#) as well as further [High Availability, Load Balancing, and Replication](#).

To test the replication you can now create a test database in the main server and check if it is replicated in the standby server:

```
sudo -u postgres createdb test # on the main server
sudo -u postgres psql -c "\l" # on the standby server
```

You need to be able to see the `test` database, that was created on the main server, in the standby server.

## Backups

PostgreSQL databases should be backed up regularly. Refer to the [PostgreSQL Administrator's Guide](#) for different approaches.

## Resources

- As mentioned above, the [PostgreSQL Administrator's Guide](#) is an excellent resource. The guide is also available in the `postgresql-doc` package. Execute the following in a terminal to install the package:

```
sudo apt install postgresql-doc
```

This package provides further man pages on postgresql 'dblink' and 'server programming interface' as well as the html guide that you'd find upstream. To view the guide enter `xdg-open /usr/share/doc/postgresql-doc-*/html/index.html` or point your browser at it.

- For general SQL information see the O'Reilly books [Getting Started with SQL: A Hands-On Approach for Beginners](#) by Thomas Nield as an entry point and [SQL in a Nutshell](#) as a quick reference.
- Also, see the [PostgreSQL Ubuntu Wiki](#) page for more information.

# LMA -> COS

The LMA stack is being succeeded by COS. While the current LMA will continue to work for the time being, most users are recommended to instead consider COS. More information available at <https://charmhub.io/topics/canonical-observability-stack/>

Logging, Monitoring, and Alerting (LMA) is a collection of tools used to guarantee the availability of your running infrastructure. Your LMA stack will help point out issues in load, networking, and other resources before it becomes a failure point.

## Architectural Overview

Canonical’s LMA stack involves several discrete software services acting in concert, including:

- Prometheus
- Prometheus Alertmanager
- Grafana
- Telegraf

Telegraf collects metrics from the operating system, running software, and other inputs. Its plugin system permits export of data in any arbitrary format; for this system we collect the data in a central data manager called Prometheus.

Prometheus works as a hub, polling data from different Telegraf nodes and sending it to various outputs, including persistent storage. For this LMA stack, visualization is handled via Grafana and email/pager alerts are generated via the Prometheus Alertmanager plugin.

## Getting Started

Let’s set up a basic demonstration with two nodes, the first acting as a placeholder load with Telegraf installed - the “*Workload*”, and the second acting as our data visualization system - the “*Monitor*”. This will help familiarize ourselves with the various components and how they interoperate.

The Workload node will be running Telegraf to collect metrics from whatever load we’re monitoring. For demo purposes we’ll just read the cpu/mem data from the node. In a real environment, we’d have multiple hosts each with their own Telegraf instance collecting hardware, network, and software status particular to that node.

Our Monitor node will double as both data store and web UI, receiving data from the Workload, storing it to disk, and displaying it for analysis.

For clarity, we’ll refer to these two hosts as named ‘workload’ and ‘monitor’. If you select other hostnames, simply substitute the correct ones as we go.

As reference, here are the ports we’ll be binding for each service:

---

Prometheus	monitor:9090
Alertmanager	monitor:9093
Grafana	monitor:3000
Telegraf	workload:9273

---

## Workload Node

First, let’s set up the Workload. We’ll be using LXD as our container technology, but there’s very little that depends on this particularly; any VM, container, or bare metal host should work for purposes of this example, so long as it’s running Ubuntu 20.10. With LXD installed in our host we can use its `lxc` command line tool to create our containers:

```
$ lxc launch ubuntu:20.10 workload
Creating workload
Starting workload
```

```
$ lxc exec workload -- bash
workload:~#
```

On the Workload, install Telegraf:

```
workload:~# apt update
workload:~# apt install telegraf
```

Telegraf processes input data to transform, filter, and decorate it, and then performs selected aggregation functions on it such as tallies, averages, etc. The results are published for collection by external services; in our case Prometheus

will be collecting the cpu:mem data to the Monitor node.

Open `/etc/telegraf/telegraf.conf` and scroll down to the “INPUT PLUGINS” section. What we’ll need is the following configuration settings, which you should find already enabled by default:

```
[[inputs.cpu]]
 percpu = true
 totalcpu = true
 collect_cpu_time = false
 report_active = false
```

Looking at the config file you’ll notice it’s almost entirely commented out. There are three different types of sections in the file: `[[inputs]]`, such as we set above; `[[outputs]]`, that we’ll set up next; and the `[[agent]]` setting with several performance tuning parameters such as the collection interval, which we’re setting to 10 seconds. The agent defaults are fine for our demo and for basic usage.

Finally, we need to define where Telegraf will provide output. Open `/etc/telegraf/telegraf.conf` and scroll down to the “OUTPUT PLUGINS” section and add the following output configuration:

```
[[outputs.prometheus_client]]
 listen = "workload:9273"
 metric_version = 2
```

```
#[[outputs.influxdb]]
```

We won’t be using Influxdb, so you can comment that section out if it’s enabled.

Now restart the Telegraf service:

```
workload:~# systemctl restart telegraf
workload:~# systemctl status telegraf
● telegraf.service - The plugin-driven server agent for reporting metrics into InfluxDB
 Loaded: loaded (/lib/systemd/system/telegraf.service; enabled; vendor preset: enabled)
 Active: active (running) since Sat 2020-10-31 02:17:57 UTC; 6s ago
 Docs: https://github.com/influxdata/telegraf
 Main PID: 2562 (telegraf)
 Tasks: 17 (limit: 77021)
 Memory: 42.2M
 CGroup: /system.slice/telegraf.service
 └─2562 /usr/bin/telegraf -config /etc/telegraf/telegraf.conf -config-directory /etc/telegraf/telegraf.d
```

```
...I! Loaded inputs: swap system cpu disk diskio kernel mem processes
...I! Loaded outputs: http prometheus_client
...I! [agent] Config: Interval:10s, Quiet:false, Hostname:"workload", Flush Interval:10s
...I! [outputs.prometheus_client] Listening on http://127.0.0.1:9273/metrics
```

Verify that it is collecting metrics by connecting to Telegraf’s web interface:

```
workload:~# wget -O- http://workload:9273/metrics

HELP cpu_usage_guest Telegraf collected metric
TYPE cpu_usage_guest gauge
cpu_usage_guest{cpu="cpu-total",host="workload"} 0
cpu_usage_guest{cpu="cpu0",host="workload"} 0
cpu_usage_guest{cpu="cpu1",host="workload"} 0
cpu_usage_guest{cpu="cpu10",host="workload"} 0
...
cpu_usage_idle{cpu="cpu-total",host="workload"} 92.74914376428686
cpu_usage_idle{cpu="cpu0",host="workload"} 86.72897196325539
cpu_usage_idle{cpu="cpu1",host="workload"} 90.11857707405758
cpu_usage_idle{cpu="cpu10",host="workload"} 95.95141700494543
```

## Monitor Node

Now let’s create the Monitor. As before, we’ll be using LXD as the container technology but if you use some other approach it should only require some adaptation:

```
$ lxc launch ubuntu:20.10 monitor
Creating monitor
```

```
Starting monitor
$ lxc exec monitor -- bash
monitor:~#
```

Make a note of the newly created container's IP address, which we'll need later on;

```
monitor:~# ip addr | grep 'inet .* global'
inet 10.69.244.104/24 brd 10.69.244.255 scope global dynamic eth0
```

Verify the Workload's Telegraf instance can be reached from the Monitor:

```
monitor:~# wget -O- http://workload:9273/metrics
```

We'll be setting up a few components to run on this node using their Snap packages. LXD images should normally have snap pre-installed but if not install it manually:

```
monitor:~# apt install snapd
```

## A. Prometheus

Prometheus will be our data manager. It collects data from external sources - Telegraf in our case - and distributes it to various destinations such as email/pager alerts, web UI's, API clients, remote storage services, etc. We'll get into those shortly.

Let's install Prometheus itself and the Prometheus Alertmanager plugin for alerts, along with a bunch of required dependencies:

```
monitor:~# snap install prometheus
monitor:~# snap install prometheus-alertmanager
```

The snap will automatically configure and start the service. To verify this, run:

```
monitor:~# snap services
Service Startup Current Notes
lxd.activate enabled inactive -
lxd.daemon enabled inactive socket-activated
prometheus.prometheus enabled active -
prometheus-alertmanager.alertmanager enabled active -
```

Verify that Prometheus is listening on the port as we expect:

```
visualizer:~# ss -tulpn | grep prometheus
tcp LISTEN 0 128 *:9090 *.* users:(("prometheus",pid=618,fd=8))
```

journalctl can be also used to review the state of snap services, particularly if more detail is desired. For example, to see where Prometheus is loading its config from:

```
monitor:~# journalctl | grep "prometheus.*config"
...
...msg="Completed loading of configuration file" filename=/var/snap/prometheus/32/prometheus.yml
```

Although the filename points to a specific snap revision (32, in this case), we can use the generic file /var/snap/prometheus/current/prometheus.yml here in order to make things more generic.

Edit this config file to register the targets we'll be reading data from. This will go under the `scrape_configs` section of the file:

```
scrape_configs:
 # The job name is added as a label `job=<job_name>` to any timeseries scraped from this config.
 - job_name: 'prometheus'

 # metrics_path defaults to '/metrics'
 # scheme defaults to 'http'.

 static_configs:
 - targets: ['localhost:9090']

 - job_name: 'telegraf'
 static_configs:
 - targets: ['workload:9273']
```

Then restart Prometheus:

```
monitor:~# snap restart prometheus
```

While we'll be using Grafana for visualization, Prometheus also has a web interface for viewing and interacting with the collected data. At this stage we can load it just to verify our setup is working properly. In a web browser, navigate to the Monitor's IP address, and port 9090. You should see Prometheus' interface, as in the following image:

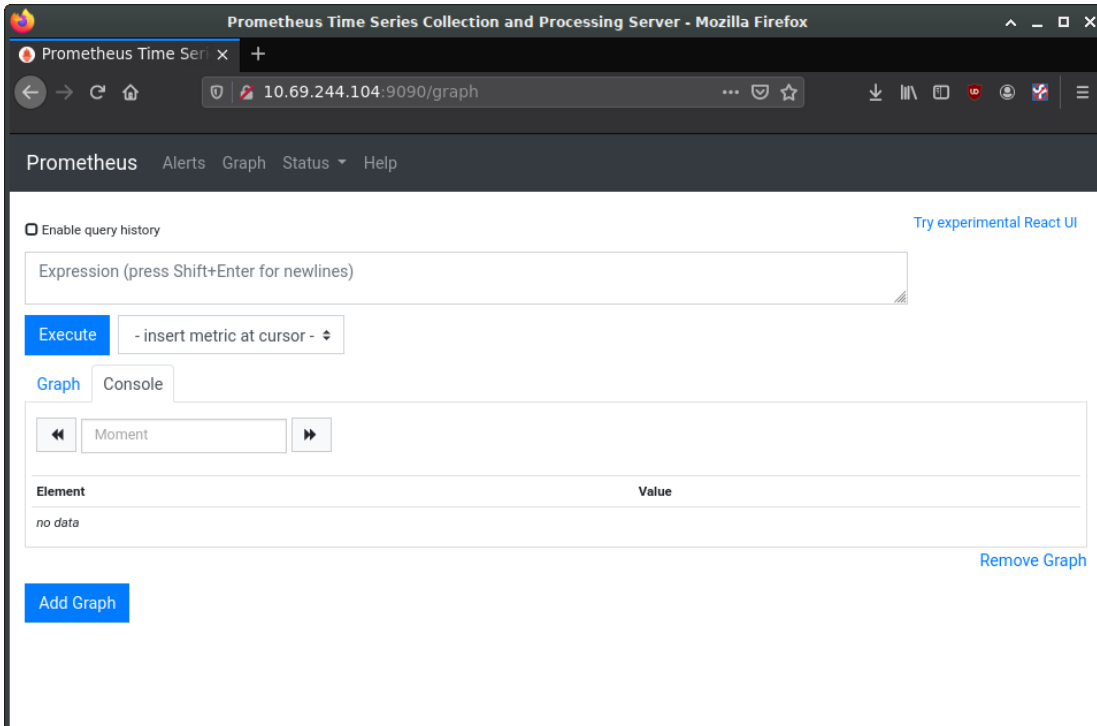

In the entry box, enter `cpu_usage_system`, select the Graph tab and click Execute. This should show a graph of our collected cpu data so far. Prometheus also has a secondary web UI using React.js.

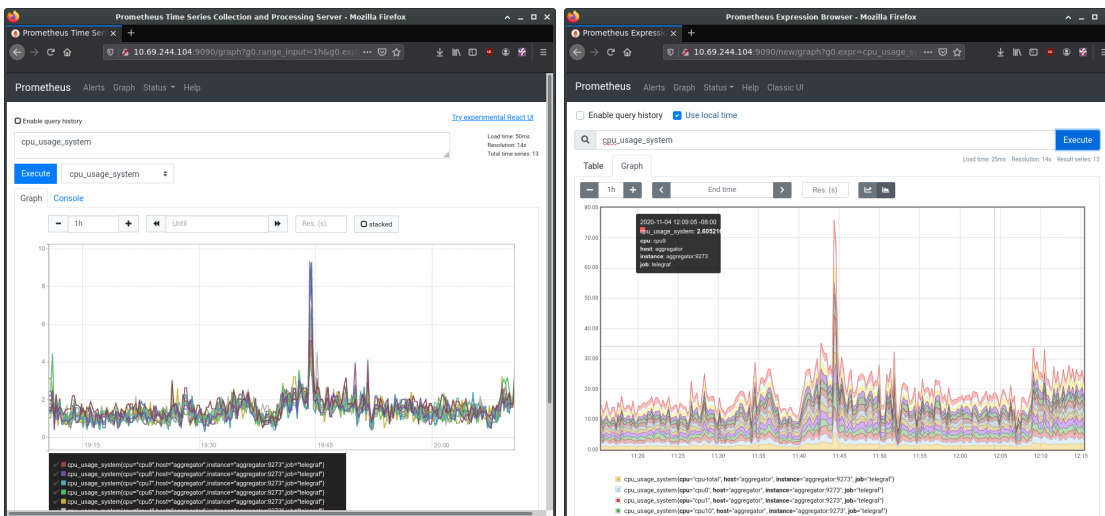

## B. Alerts

Let's tackle the Alert Manager next.

Edit `/var/snap/prometheus/current/prometheus.yml` again, adding the following to the `alerting` and `rules_files` sections:

```
/var/snap/prometheus/current/prometheus.yml
#...
Alertmanager configuration
alerting:
 alertmanagers:
 - static_configs:
 - targets:
 - 127.0.0.1:9093
rule_files:
```

```
- 'alerts.yml'
```

Now create `/var/snap/prometheus/current/alerts.yml` with the following contents:

```
/var/snap/prometheus/current/alerts.yml
groups:
- name: demo-alerts
 rules:
 - alert: HighLoad
 expr: node_load1 > 2.0
 for: 60m
 labels:
 severity: normal
 annotations:
 description: '{{ $labels.instance }} of job {{ $labels.job }} is under high load.'
 summary: Instance {{ $labels.instance }} under high load.
 value: '{{ $value }}'

 - alert: InstanceDown
 expr: up == 0
 for: 5m
 labels:
 severity: major
 annotations:
 summary: "Instance {{ $labels.instance }} down"
 description: "{{ $labels.instance }} of job {{ $labels.job }} has been down for more than 5 minutes."
```

This adds two alerts: one for high processor load, and one to report if the node has been unreachable for over 5 minutes. We're considering high cpu to be a load of 2 or higher for an hour; obviously this would need set to something more sensible for the style of workloads your production system experiences.

With the alerts themselves now defined, we next need to instruct Prometheus's alert manager how to handle them. There is a sample configuration installed to `/var/snap/prometheus-alertmanager/current/alertmanager.yml`, however it's full of example data. Instead, replace it entirely with this content:

```
/var/snap/prometheus-alertmanager/current/alertmanager.yml
global:
 resolve_timeout: 5m

route:
 group_by: ['alertname']
 group_wait: 10s
 group_interval: 10s
 repeat_interval: 1h

inhibit_rules:
- source_match:
 severity: 'critical'
 target_match:
 severity: 'warning'
 equal: ['alertname', 'dev', 'instance']
```

Restart the alertmanager after making the configuration change:

```
workload:~# snap restart prometheus-alertmanager
```

## C. Grafana

Grafana provides our main dashboard, from which we can generate graphs and other visuals to study the collected metrics. Grafana can read its data directly from log files, but we'll focus on using Prometheus as its principle data source. Grafana is available as a snap. You can install it like this:

```
monitor:~# snap install grafana
grafana 6.7.4 from Alvaro Uría (aluria) installed
```

It uses port 3000:

```
ss -tulpn | grep grafana
```

```
tcp LISTEN 0 128 *:3000 *: users:(("grafana-server",pid=1449,fd=10))
```

We next need to know where it expects its configuration:

```
monitor:~# journalctl | grep "grafana.*conf"
... msg="Config loaded from" logger=settings file=/snap/grafana/36/conf/defaults.ini
... msg="Config overridden from Environment variable" logger=settings var="GF_PATHS_PROVISIONING=/var/snap/grafana/comm
... error="open /var/snap/grafana/common/conf/provisioning/datasources: no such file or directory"
...
```

So we see it's getting its defaults from `/snap/grafana/36/conf/`, but `/snap/` is a read-only directory and therefore we cannot edit the file. Instead, we should put our customizations inside `/var/snap/grafana/36/conf/grafana.ini`. You can also use the generic path `/var/snap/grafana/current/conf/grafana.ini`.

For a production installation, the `defaults.ini` has numerous parameters we'd want to customize for our site, however for the demo we'll accept all the defaults. We do need to configure our data sources, but can do this via the web interface:

```
$ firefox http://10.69.244.104:3000
```

Login with 'admin' and 'admin' as the username and password. This should bring you to the main Grafana page, where you can find links to tutorials and documentation. Go ahead and delete any example data sources and/or dashboards.

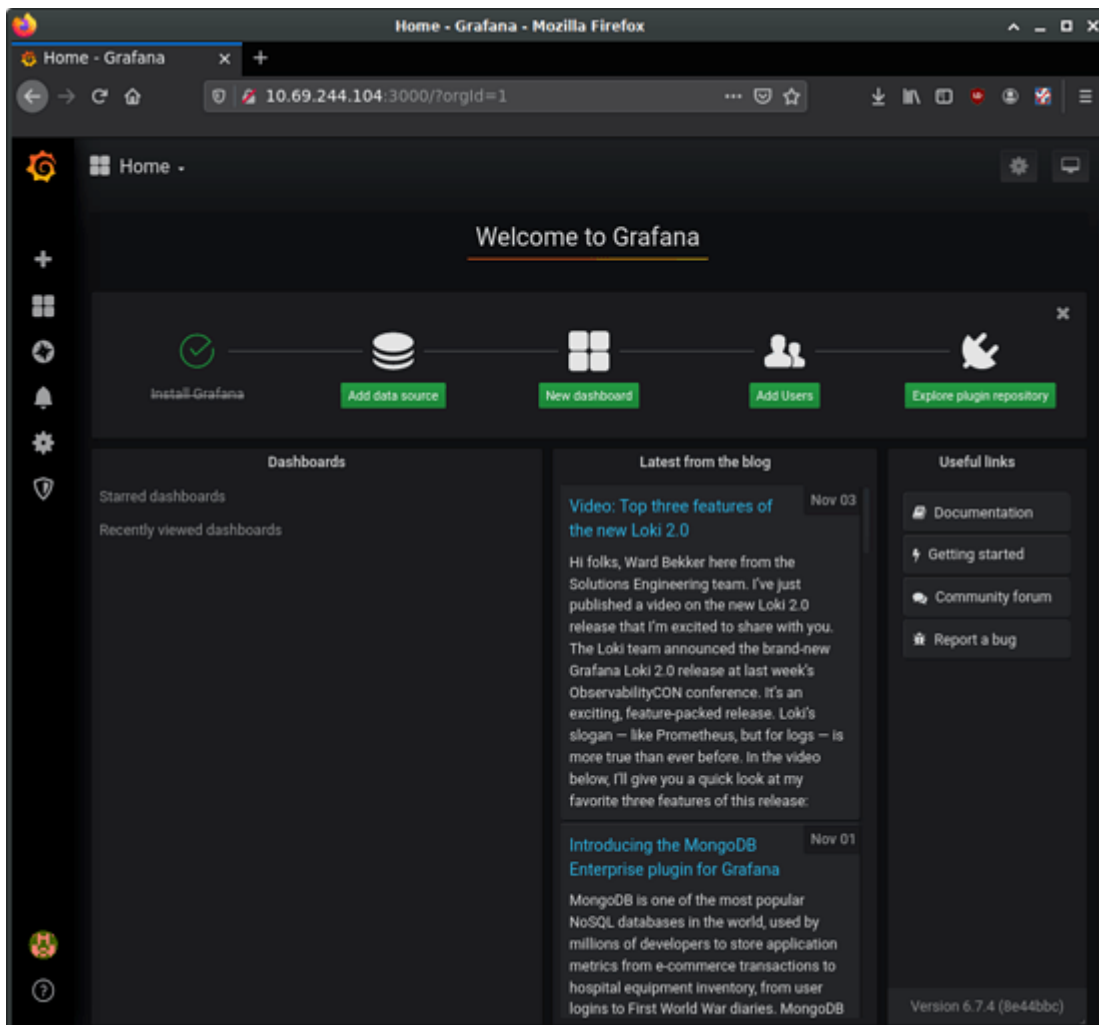

grafana\_0960x888 98.5 KB

Select the button to add a new data source and select "Prometheus". On the "Data Sources / Prometheus" edit page, set the name to Prometheus, URL to `http://localhost:9090`, and Access to "Server (default)" to make Grafana pull data from the Prometheus service we set up. The remaining settings can be left to defaults. Click "Save & Test".

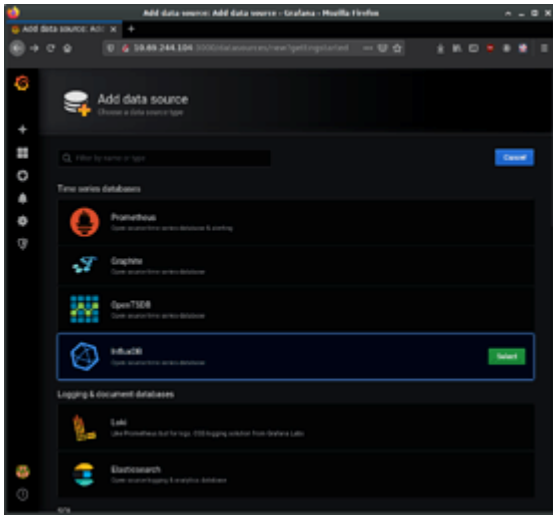

grafana\_1960×888 79.3 KB

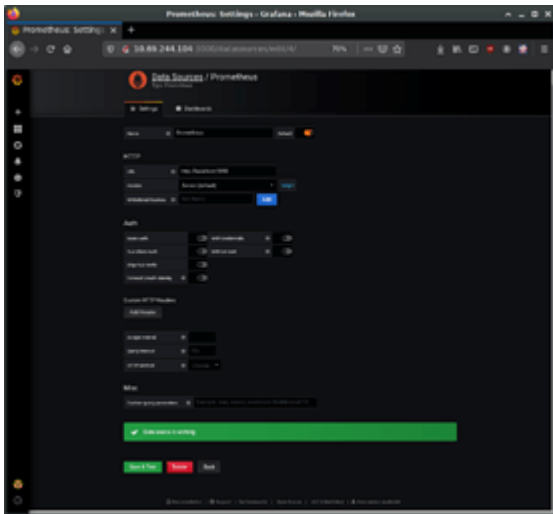

grafana\_2960×888 64.9 KB

Returning to the Grafana home page, next set up a “New Dashboard”. A dashboard can hold one or more panels, each of which can be connected to one or more data queries. Let’s add a panel for CPU data. For the query, enter “cpu\_usage\_system” in the Metrics field.

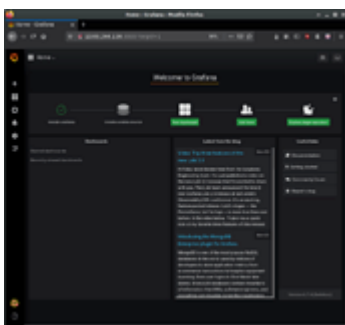

grafana\_3960×888 92.8 KB

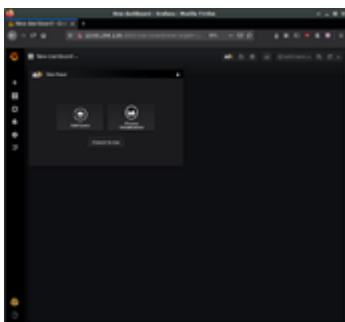



grafana\_4960×888 44.6 KB



grafana\_5960×888 107 KB

On the left you can see four buttons to configure four elements of the panel: It's data source, its visualization, general settings, and alerts. The general settings page allows us to set a title for the panel, for instance. Make any other customizations you desire, and then save the dashboard using the save icon at the top of the page.

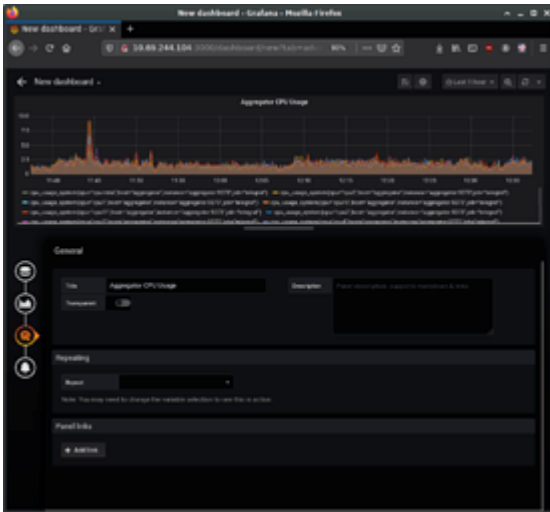

grafana\_6960×888 112 KB

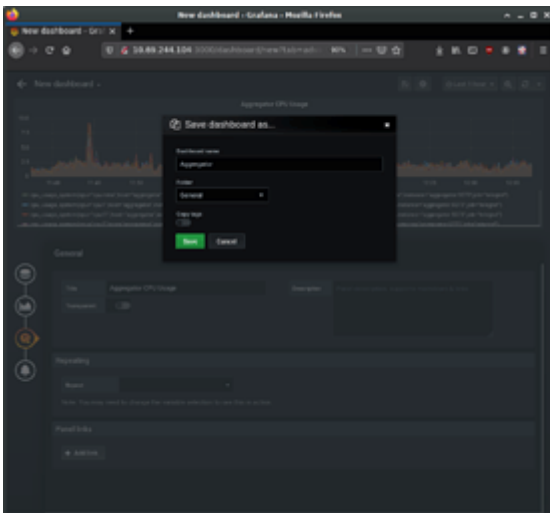

grafana\_7960×888 90.1 KB

Using the same procedure, add additional panels for processor load and memory usage. Panels can be used to present other types of data as well, such as numerical indicators, logs, newsfeeds, or markdown-formatted documentation. For example, you can add a panel to display the system uptime, such as in the following image:

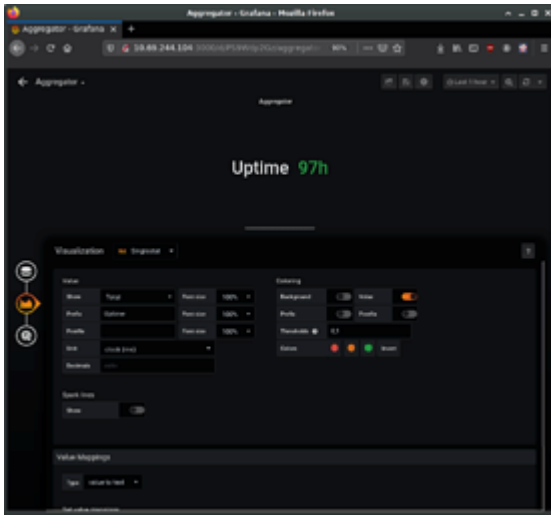

grafana\_9960×888 58.1 KB

Try also adding a panel with the “Text” visualization option for entering descriptive text about our demo. Save, and then view the final dashboard:

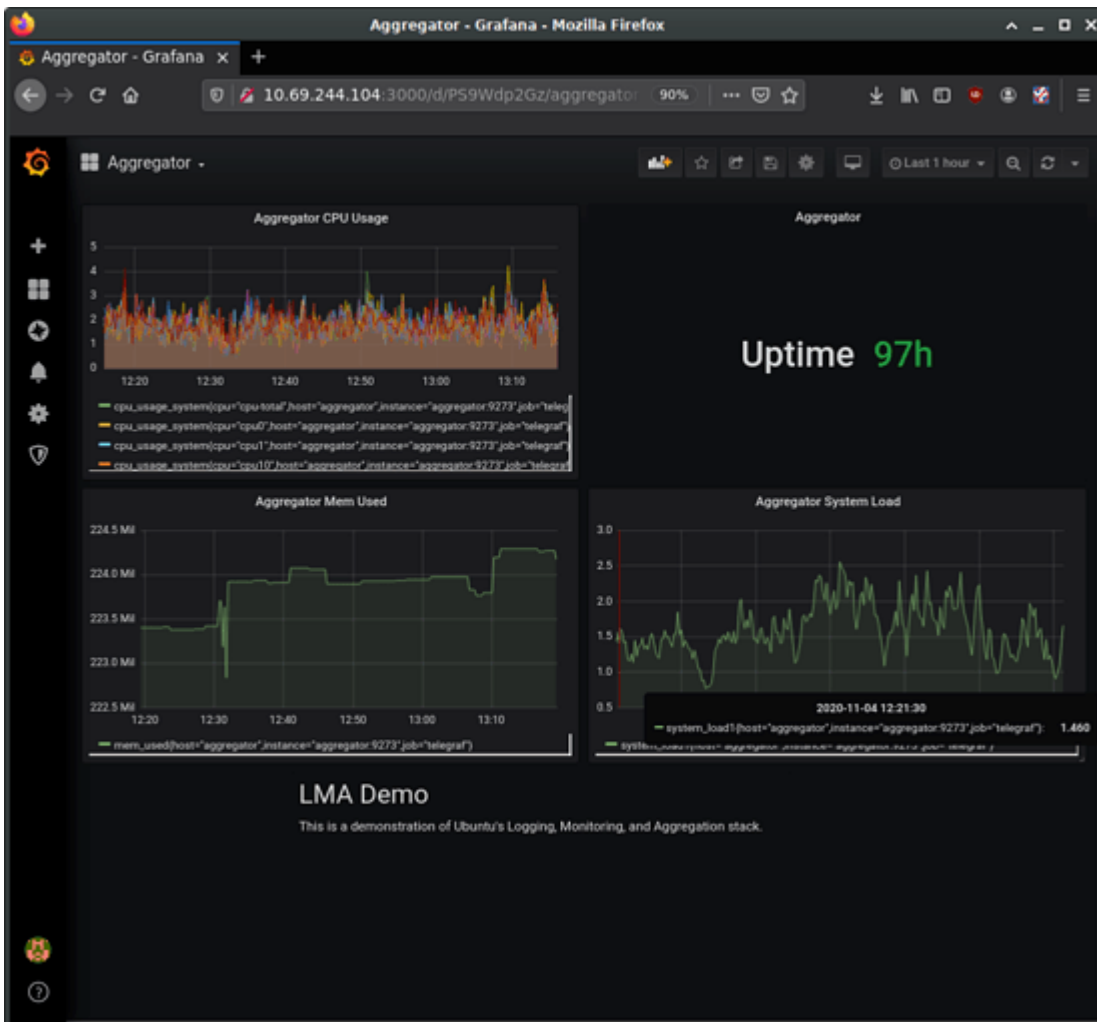

grafana\_X960×888 141 KB

## Overview

The monitoring of essential servers and services is an important part of system administration. Most network services are monitored for performance, availability, or both. This section will cover installation and configuration of Nagios for availability monitoring, and Munin for performance monitoring.

The examples in this section will use two servers with hostnames *server01* and *server02*. *Server01* will be configured with Nagios to monitor services on itself and *server02*. *Server01* will also be setup with the munin package to gather

information from the network. Using the munin-node package, *server02* will be configured to send information to *server01*.

Hopefully these simple examples will allow you to monitor additional servers and services on your network.

## Nagios

### Installation

First, on *server01* install the nagios package. In a terminal enter:

```
sudo apt install nagios3 nagios-nrpe-plugin
```

You will be asked to enter a password for the *nagiosadmin* user. The user's credentials are stored in */etc/nagios3/htpasswd.users*. To change the *nagiosadmin* password, or add additional users to the Nagios CGI scripts, use the *htpasswd* that is part of the *apache2-utils* package.

For example, to change the password for the *nagiosadmin* user enter:

```
sudo htpasswd /etc/nagios3/htpasswd.users nagiosadmin
```

To add a user:

```
sudo htpasswd /etc/nagios3/htpasswd.users steve
```

Next, on *server02* install the nagios-nrpe-server package. From a terminal on *server02* enter:

```
sudo apt install nagios-nrpe-server
```

#### Note

NRPE allows you to execute local checks on remote hosts. There are other ways of accomplishing this through other Nagios plugins as well as other checks.

### Configuration Overview

There are a couple of directories containing Nagios configuration and check files.

- */etc/nagios3*: contains configuration files for the operation of the nagios daemon, CGI files, hosts, etc.
- */etc/nagios-plugins*: houses configuration files for the service checks.
- */etc/nagios*: on the remote host contains the nagios-nrpe-server configuration files.
- */usr/lib/nagios/plugins/*: where the check binaries are stored. To see the options of a check use the *-h* option.

For example: */usr/lib/nagios/plugins/check\_dhcp -h*

There are a plethora of checks Nagios can be configured to execute for any given host. For this example Nagios will be configured to check disk space, DNS, and a MySQL hostgroup. The DNS check will be on *server02*, and the MySQL hostgroup will include both *server01* and *server02*.

#### Note

See details on setting up [MySQL](#).

Additionally, there are some terms that once explained will hopefully make understanding Nagios configuration easier:

- *Host*: a server, workstation, network device, etc that is being monitored.
- *Host Group*: a group of similar hosts. For example, you could group all web servers, file server, etc.
- *Service*: the service being monitored on the host. Such as HTTP, DNS, NFS, etc.
- *Service Group*: allows you to group multiple services together. This is useful for grouping multiple HTTP for example.
- *Contact*: person to be notified when an event takes place. Nagios can be configured to send emails, SMS messages, etc.

By default Nagios is configured to check HTTP, disk space, SSH, current users, processes, and load on the *localhost*. Nagios will also ping check the *gateway*.

Large Nagios installations can be quite complex to configure. It is usually best to start small, one or two hosts, get things configured the way you like then expand.

## Configuration

- First, create a *host* configuration file for *server02*. Unless otherwise specified, run all these commands on *server01*. In a terminal enter:

```
sudo cp /etc/nagios3/conf.d/localhost_nagios2.cfg \
/etc/nagios3/conf.d/server02.cfg
```

### Note

In the above and following command examples, replace “*server01*”, “*server02*” *172.18.100.100*, and *172.18.100.101* with the host names and IP addresses of your servers.

Next, edit */etc/nagios3/conf.d/server02.cfg*:

```
define host{
 use generic-host ; Name of host template to use
 host_name server02
 alias Server 02
 address 172.18.100.101
}

check DNS service.
define service {
 use generic-service
 host_name server02
 service_description DNS
 check_command check_dns!172.18.100.101
}
```

Restart the nagios daemon to enable the new configuration:

```
sudo systemctl restart nagio3.service
```

- Now add a service definition for the MySQL check by adding the following to */etc/nagios3/conf.d/services\_nagios2.cfg*:

```
check MySQL servers.
define service {
 hostgroup_name mysql-servers
 service_description MySQL
 check_command check_mysql_cmdlinecred!nagios!secret!$HOSTADDRESS
 use generic-service
 notification_interval 0 ; set > 0 if you want to be renotified
}
```

A *mysql-servers* hostgroup now needs to be defined. Edit */etc/nagios3/conf.d/hostgroups\_nagios2.cfg* adding:

```
MySQL hostgroup.
define hostgroup {
 hostgroup_name mysql-servers
 alias MySQL servers
 members localhost, server02
}
```

The Nagios check needs to authenticate to MySQL. To add a *nagios* user to MySQL enter:

```
mysql -u root -p -e "create user nagios identified by 'secret';"
```

### Note

The *nagios* user will need to be added all hosts in the *mysql-servers* hostgroup.

Restart nagios to start checking the MySQL servers.

```
sudo systemctl restart nagios3.service
```

- Lastly configure NRPE to check the disk space on *server02*.

On *server01* add the service check to */etc/nagios3/conf.d/server02.cfg*:

```
NRPE disk check.
define service {
 use generic-service
```

```

 host_name server02
 service_description nrpe-disk
 check_command check_nrpe_larg!check_all_disks!172.18.100.101
 }

```

Now on *server02* edit `/etc/nagios/nrpe.cfg` changing:

```
allowed_hosts=172.18.100.100
```

And below in the command definition area add:

```
command[check_all_disks]=/usr/lib/nagios/plugins/check_disk -w 20% -c 10% -e
```

Finally, restart `nagios-nrpe-server`:

```
sudo systemctl restart nagios-nrpe-server.service
```

Also, on *server01* restart `nagios`:

```
sudo systemctl restart nagios3.service
```

You should now be able to see the host and service checks in the Nagios CGI files. To access them point a browser to `http://server01/nagios3`. You will then be prompted for the *nagiosadmin* username and password.

## References

This section has just scratched the surface of Nagios' features. The `nagios-plugins-extra` and `nagios-snmp-plugins` contain many more service checks.

- For more information see [Nagios website](#).
- Specifically the [Nagios Online Documentation](#) site.
- There is also a list of [books](#) related to Nagios and network monitoring:
- The [Nagios Ubuntu Wiki](#) page also has more details.

## Munin

### Installation

Before installing Munin on *server01* `apache2` will need to be installed. The default configuration is fine for running a munin server. For more information see [setting up Apache](#).

First, on *server01* install `munin`. In a terminal enter:

```
sudo apt install munin
```

Now on *server02* install the `munin-node` package:

```
sudo apt install munin-node
```

### Configuration

On *server01* edit the `/etc/munin/munin.conf` adding the IP address for *server02*:

```
First our "normal" host.
[server02]
 address 172.18.100.101
```

#### Note

Replace *server02* and *172.18.100.101* with the actual hostname and IP address for your server.

Next, configure `munin-node` on *server02*. Edit `/etc/munin/munin-node.conf` to allow access by *server01*:

```
allow ^172\.18\.100\.100$
```

#### Note

Replace `^172\.18\.100\.100$` with IP address for your munin server.

Now restart `munin-node` on *server02* for the changes to take effect:

```
sudo systemctl restart munin-node.service
```

Finally, in a browser go to `http://server01/munin`, and you should see links to nice graphs displaying information from the standard *munin-plugins* for disk, network, processes, and system.

## Note

Since this is a new install it may take some time for the graphs to display anything useful.

## Additional Plugins

The `munin-plugins-extra` package contains performance checks additional services such as DNS, DHCP, Samba, etc. To install the package, from a terminal enter:

```
sudo apt install munin-plugins-extra
```

Be sure to install the package on both the server and node machines.

## References

- See the [Munin](#) website for more details.
- Specifically the [Munin Documentation](#) page includes information on additional plugins, writing plugins, etc.

Logs are an invaluable source of information about problems that may arise in your server. Logwatch keeps an eye on your logs for you, flags items that may be of interest, and report them via email.

Install Logwatch using the normal method:

```
$ sudo apt install logwatch
```

You will also need to manually create its temporary directory in order for it to work:

```
$ sudo mkdir /var/cache/logwatch
```

Logwatch's stock configuration is kept in `/usr/share/logwatch/default.conf/logwatch.conf`, however rather than edit our configuration changes directly to that file, the convention is to copy it into `/etc` for modification:

```
$ sudo cp /usr/share/logwatch/default.conf/logwatch.conf /etc/logwatch/conf/
```

With your favorite editor, open `/etc/logwatch/conf/logwatch.conf`. The uncommented lines indicate the default configuration values. First, lets customize some of the basics:

```
Output = mail
MailTo = me@mydomain.org
MailFrom = logwatch@host1.mydomain.org
Detail = Low
Service = All
```

This assumes you've set up mail services on `host1` that enables it to deliver email to your `me@mydomain.org` address. These emails will be addressed as from `logwatch@host1.mydomain.org`.

The Detail level defines how much information is included in the reports. Other values are Medium and High.

Logwatch will then monitor logs for all services on the system, unless specified otherwise with the Service parameter. If there are undesired services being included in the reports, they can be disabled by removing them with additional Service fields. E.g.:

```
Service = "-http"
Service = "-eximstats"
```

Next, run Logwatch manually to verify your configuration changes are valid.

```
$ sudo logwatch --detail Low --range today
```

```
Logwatch 7.4.3 (12/07/16)
Processing Initiated: Fri Apr 24 16:58:14 2020
Date Range Processed: today
(2020-Apr-24)
Period is day.
```

```
Detail Level of Output: 0
```

```
Type of Output/Format: stdout / text
```

```
Logfiles for Host: host1.mydomain.org
```

```
#####
```

```
----- pam_unix Begin -----
```

```
sudo:
```

```
Sessions Opened:
```

```
bryce -> root: 1 Time(s)
```

```

----- pam_unix End -----
----- rsnapshot Begin -----

ERRORS:
/usr/bin/rsnapshot hourly: completed, but with some errors: 5 Time(s)
/usr/bin/rsync returned 127 while processing root@host2:/etc/: 5 Time(s)
/usr/bin/rsync returned 127 while processing root@host2:/home/: 5 Time(s)
/usr/bin/rsync returned 127 while processing root@host2:/proc/uptime: 5 Time(s)
/usr/bin/rsync returned 127 while processing root@host3:/etc/: 5 Time(s)
/usr/bin/rsync returned 127 while processing root@host3:/home/: 5 Time(s)
/usr/bin/rsync returned 127 while processing root@host3:/proc/uptime: 5 Time(s)
----- rsnapshot End -----

----- SSHD Begin -----

Users logging in through sshd:
bryce:
192.168.1.123 (host4.mydomain.org): 1 time
----- SSHD End -----

----- Sudo (secure-log) Begin -----

bryce => root

/bin/bash - 1 Time(s).
----- Sudo (secure-log) End -----

----- Disk Space Begin -----

Filesystem Size Used Avail Use% Mounted on
/dev/sdc1 220G 19G 190G 9% /
/dev/loop1 157M 157M 0 100% /snap/gnome-3-28-1804/110
/dev/loop11 1.0M 1.0M 0 100% /snap/gnome-logs/81
/dev/md5 9.1T 7.3T 1.8T 81% /srv/Products
/dev/md6 9.1T 5.6T 3.5T 62% /srv/Archives
/dev/loop14 3.8M 3.8M 0 100% /snap/gnome-system-monitor/127
/dev/loop17 15M 15M 0 100% /snap/gnome-characters/399
/dev/loop18 161M 161M 0 100% /snap/gnome-3-28-1804/116
/dev/loop6 55M 55M 0 100% /snap/core18/1668
/dev/md1 1.8T 1.3T 548G 71% /srv/Staff
/dev/md0 3.6T 3.5T 84G 98% /srv/Backup
/dev/loop2 1.0M 1.0M 0 100% /snap/gnome-logs/93
/dev/loop5 15M 15M 0 100% /snap/gnome-characters/495
/dev/loop8 3.8M 3.8M 0 100% /snap/gnome-system-monitor/135
/dev/md7 3.6T 495G 3.0T 15% /srv/Customers
/dev/loop9 55M 55M 0 100% /snap/core18/1705
/dev/loop10 94M 94M 0 100% /snap/core/8935
/dev/loop0 55M 55M 0 100% /snap/gtk-common-themes/1502
/dev/loop4 63M 63M 0 100% /snap/gtk-common-themes/1506
/dev/loop3 94M 94M 0 100% /snap/core/9066

/srv/Backup (/dev/md0) => 98% Used. Warning. Disk Filling up.
----- Disk Space End -----

Logwatch End

```

There are many ways to backup an Ubuntu installation. The most important thing about backups is to develop a *backup plan* consisting of what to backup, where to back it up to, and how to restore it.

It is good practice to take backup media off-site in case of a disaster. For backup plans involving physical tape or removable hard drives, the tapes or drives can be manually taken off-site, but in other cases this may not be practical and the archives will need copied over a WAN link to a server in another location.

The shell script in [Shell Scripts](#) only allows for seven different archives. For a server whose data doesn't change often, this may be enough. If the server has a large amount of data, a more complex rotation scheme should be used.

## Rotating NFS Archives

In this section, the shell script will be slightly modified to implement a grandfather-father-son rotation scheme (monthly-weekly-daily):

- The rotation will do a *daily* backup Sunday through Friday.
- On Saturday a *weekly* backup is done giving you four weekly backups a month.
- The *monthly* backup is done on the first of the month rotating two monthly backups based on if the month is odd or even.

Here is the new script:

```
#!/bin/bash
#####
#
Backup to NFS mount script with
grandfather-father-son rotation.
#
#####

What to backup.
backup_files="/home /var/spool/mail /etc /root /boot /opt"

Where to backup to.
dest="/mnt/backup"

Setup variables for the archive filename.
day=$(date +%A)
hostname=$(hostname -s)

Find which week of the month 1-4 it is.
day_num=$(date +%d)
if (($day_num <= 7)); then
 week_file="$hostname-week1.tgz"
elif (($day_num > 7 && $day_num <= 14)); then
 week_file="$hostname-week2.tgz"
elif (($day_num > 14 && $day_num <= 21)); then
 week_file="$hostname-week3.tgz"
elif (($day_num > 21 && $day_num < 32)); then
 week_file="$hostname-week4.tgz"
fi

Find if the Month is odd or even.
month_num=$(date +%m)
month=$(expr $month_num % 2)
if [$month -eq 0]; then
 month_file="$hostname-month2.tgz"
else
 month_file="$hostname-month1.tgz"
fi

Create archive filename.
if [$day_num == 1]; then
 archive_file=$month_file
elif [$day != "Saturday"]; then
 archive_file="$hostname-$day.tgz"
else
 archive_file=$week_file
fi

Print start status message.
echo "Backing up $backup_files to $dest/$archive_file"
date
echo
```



```

Backup the files using tar.
tar czf $dest/$archive_file $backup_files

Print end status message.
echo
echo "Backup finished"
date

Long listing of files in $dest to check file sizes.
ls -lh $dest/

```

The script can be executed using the same methods as in [Executing the Script](#).

As discussed in the introduction, a copy of the backup archives and/or media can then be transferred off-site.

## Tape Drives

A tape drive attached to the server can be used instead of an NFS share. Using a tape drive simplifies archive rotation, and makes taking the media off-site easier as well.

When using a tape drive, the filename portions of the script aren't needed because the data is sent directly to the tape device. Some commands to manipulate the tape are needed. This is accomplished using `mt`, a magnetic tape control utility part of the `cpio` package.

Here is the shell script modified to use a tape drive:

```

#!/bin/bash
#####
#
Backup to tape drive script.
#
#####

What to backup.
backup_files="/home /var/spool/mail /etc /root /boot /opt"

Where to backup to.
dest="/dev/st0"

Print start status message.
echo "Backing up $backup_files to $dest"
date
echo

Make sure the tape is rewound.
mt -f $dest rewind

Backup the files using tar.
tar czf $dest $backup_files

Rewind and eject the tape.
mt -f $dest rewoffl

Print end status message.
echo
echo "Backup finished"
date

```

### Note

The default device name for a SCSI tape drive is `/dev/st0`. Use the appropriate device path for your system.

Restoring from a tape drive is basically the same as restoring from a file. Simply rewind the tape and use the device path instead of a file path. For example to restore the `/etc/hosts` file to `/tmp/etc/hosts`:

```
mt -f /dev/st0 rewind
```

```
tar -xzf /dev/st0 -C /tmp etc/hosts
```

Bacula is a backup program enabling you to backup, restore, and verify data across your network. There are Bacula clients for Linux, Windows, and Mac OS X - making it a cross-platform network wide solution.

## Overview

Bacula is made up of several components and services used to manage which files to backup and backup locations:

- Bacula Director: a service that controls all backup, restore, verify, and archive operations.
- Bacula Console: an application allowing communication with the Director. There are three versions of the Console:
  - Text based command line version.
  - Gnome based GTK+ Graphical User Interface (GUI) interface.
  - wxWidgets GUI interface.
- Bacula File: also known as the Bacula Client program. This application is installed on machines to be backed up, and is responsible for the data requested by the Director.
- Bacula Storage: the programs that perform the storage and recovery of data to the physical media.
- Bacula Catalog: is responsible for maintaining the file indexes and volume databases for all files backed up, enabling quick location and restoration of archived files. The Catalog supports three different databases MySQL, PostgreSQL, and SQLite.
- Bacula Monitor: allows the monitoring of the Director, File daemons, and Storage daemons. Currently the Monitor is only available as a GTK+ GUI application.

These services and applications can be run on multiple servers and clients, or they can be installed on one machine if backing up a single disk or volume.

## Installation

### Note

If using MySQL or PostgreSQL as your database, you should already have the services available. Bacula will not install them for you. For more information take a look at [Databases -MySQL](#) and [Databases - PostgreSQL](#).

There are multiple packages containing the different Bacula components. To install Bacula, from a terminal prompt enter:

```
sudo apt install bacula
```

By default installing the bacula package will use a PostgreSQL database for the Catalog. If you want to use SQLite or MySQL, for the Catalog, install `bacula-director-sqlite3` or `bacula-director-mysql` respectively.

During the install process you will be asked to supply a password for the database *owner* of the *bacula* database.

## Configuration

Bacula configuration files are formatted based on *resources* comprising of *directives* surrounded by “{}” braces. Each Bacula component has an individual file in the `/etc/bacula` directory.

The various Bacula components must authorize themselves to each other. This is accomplished using the *password* directive. For example, the *Storage* resource password in the `/etc/bacula/bacula-dir.conf` file must match the *Director* resource password in `/etc/bacula/bacula-sd.conf`.

By default the backup job named *BackupClient1* is configured to archive the Bacula Catalog. If you plan on using the server to backup more than one client you should change the name of this job to something more descriptive. To change the name edit `/etc/bacula/bacula-dir.conf`:

```
#
Define the main nightly save backup job
By default, this job will back up to disk in
Job {
 Name = "BackupServer"
 JobDefs = "DefaultJob"
 Write Bootstrap = "/var/lib/bacula/Client1.bsr"
```

```
}
```

### Note

The example above changes the job name to *BackupServer* matching the machine's host name. Replace "BackupServer" with your appropriate hostname, or other descriptive name.

The *Console* can be used to query the *Director* about jobs, but to use the Console with a *non-root* user, the user needs to be in the *bacula* group. To add a user to the bacula group enter the following from a terminal:

```
sudo adduser $username bacula
```

### Note

Replace *\$username* with the actual username. Also, if you are adding the current user to the group you should log out and back in for the new permissions to take effect.

## Localhost Backup

This section describes how to backup specified directories on a single host to a local tape drive.

- First, the *Storage* device needs to be configured. Edit */etc/bacula/bacula-sd.conf* add:

```
Device {
 Name = "Tape Drive"
 Device Type = tape
 Media Type = DDS-4
 Archive Device = /dev/st0
 Hardware end of medium = No;
 AutomaticMount = yes; # when device opened, read it
 AlwaysOpen = Yes;
 RemovableMedia = yes;
 RandomAccess = no;
 Alert Command = "sh -c 'tapeinfo -f %c | grep TapeAlert'"
}
```

The example is for a *DDS-4* tape drive. Adjust the "Media Type" and "Archive Device" to match your hardware. You could also uncomment one of the other examples in the file.

- After editing */etc/bacula/bacula-sd.conf* the Storage daemon will need to be restarted:

```
sudo systemctl restart bacula-sd.service
```

- Now add a *Storage* resource in */etc/bacula/bacula-dir.conf* to use the new Device:

```
Definition of "Tape Drive" storage device
Storage {
 Name = TapeDrive
 # Do not use "localhost" here
 Address = backupserver # N.B. Use a fully qualified name here
 SDPort = 9103
 Password = "Cv70F6pfl1t6pBopT4vQ0nigDrR0v3LT3Cgkiyjc"
 Device = "Tape Drive"
 Media Type = tape
}
```

The *Address* directive needs to be the Fully Qualified Domain Name (FQDN) of the server. Change *backupserver* to the actual host name.

Also, make sure the *Password* directive matches the password string in */etc/bacula/bacula-sd.conf*.

- Create a new *FileSet*, which will determine what directories to backup, by adding:

```
LocalhostBacup FileSet.
FileSet {
 Name = "LocalhostFiles"
 Include {
 Options {
 signature = MD5
 compression=GZIP
 }
 }
}
```

```

 File = /etc
 File = /home
}
}

```

This *FileSet* will backup the */etc* and */home* directories. The *Options* resource directives configure the *FileSet* to create an MD5 signature for each file backed up, and to compress the files using GZIP.

- Next, create a new *Schedule* for the backup job:

```

LocalhostBackup Schedule -- Daily.
Schedule {
 Name = "LocalhostDaily"
 Run = Full daily at 00:01
}

```

The job will run every day at 00:01 or 12:01 am. There are many other scheduling options available.

- Finally create the *Job*:

```

Localhost backup.
Job {
 Name = "LocalhostBackup"
 JobDefs = "DefaultJob"
 Enabled = yes
 Level = Full
 FileSet = "LocalhostFiles"
 Schedule = "LocalhostDaily"
 Storage = TapeDrive
 Write Bootstrap = "/var/lib/bacula/LocalhostBackup.bsr"
}

```

The job will do a *Full* backup every day to the tape drive.

- Each tape used will need to have a *Label*. If the current tape does not have a label Bacula will send an email letting you know. To label a tape using the Console enter the following from a terminal:

```
bconsole
```

- At the Bacula Console prompt enter:

```
label
```

- You will then be prompted for the *Storage* resource:

```

Automatically selected Catalog: MyCatalog
Using Catalog "MyCatalog"
The defined Storage resources are:
 1: File
 2: TapeDrive
Select Storage resource (1-2):2

```

- Enter the new *Volume* name:

```

Enter new Volume name: Sunday
Defined Pools:
 1: Default
 2: Scratch

```

Replace *Sunday* with the desired label.

- Now, select the *Pool*:

```

Select the Pool (1-2): 1
Connecting to Storage daemon TapeDrive at backupserver:9103 ...
Sending label command for Volume "Sunday" Slot 0 ...

```

Congratulations, you have now configured *Bacula* to backup the localhost to an attached tape drive.

## Resources

- For more *Bacula* configuration options, refer to [Bacula's Documentation](#).

- The [Bacula Home Page](#) contains the latest Bacula news and developments.
- Also, see the [Bacula Ubuntu Wiki](#) page.

One of the simplest ways to backup a system is using a *shell script*. For example, a script can be used to configure which directories to backup, and pass those directories as arguments to the tar utility, which creates an archive file. The archive file can then be moved or copied to another location. The archive can also be created on a remote file system such as an *NFS* mount.

The tar utility creates one archive file out of many files or directories. tar can also filter the files through compression utilities, thus reducing the size of the archive file.

## Simple Shell Script

The following shell script uses tar to create an archive file on a remotely mounted NFS file system. The archive filename is determined using additional command line utilities.

```
#!/bin/bash
#####
#
Backup to NFS mount script.
#
#####

What to backup.
backup_files="/home /var/spool/mail /etc /root /boot /opt"

Where to backup to.
dest="/mnt/backup"

Create archive filename.
day=$(date +%A)
hostname=$(hostname -s)
archive_file="$hostname-$day.tgz"

Print start status message.
echo "Backing up $backup_files to $dest/$archive_file"
date
echo

Backup the files using tar.
tar czf $dest/$archive_file $backup_files

Print end status message.
echo
echo "Backup finished"
date

Long listing of files in $dest to check file sizes.
ls -lh $dest
```

- *\$backup\_files*: a variable listing which directories you would like to backup. The list should be customized to fit your needs.
- *\$day*: a variable holding the day of the week (Monday, Tuesday, Wednesday, etc). This is used to create an archive file for each day of the week, giving a backup history of seven days. There are other ways to accomplish this including using the date utility.
- *\$hostname*: variable containing the *short* hostname of the system. Using the hostname in the archive filename gives you the option of placing daily archive files from multiple systems in the same directory.
- *\$archive\_file*: the full archive filename.
- *\$dest*: destination of the archive file. The directory needs to be created and in this case *mounted* before executing the backup script. See [???](#) for details of using *NFS*.
- *status messages*: optional messages printed to the console using the echo utility.
- *tar czf \$dest/\$archive\_file \$backup\_files*: the tar command used to create the archive file.

- *c*: creates an archive.
- *z*: filter the archive through the gzip utility compressing the archive.
- *f*: output to an archive file. Otherwise the tar output will be sent to STDOUT.
- *ls -lh \$dest*: optional statement prints a *-l* long listing in *-h* human readable format of the destination directory. This is useful for a quick file size check of the archive file. This check should not replace testing the archive file.

This is a simple example of a backup shell script; however there are many options that can be included in such a script. See [References](#) for links to resources providing more in-depth shell scripting information.

## Executing the Script

### Executing from a Terminal

The simplest way of executing the above backup script is to copy and paste the contents into a file. `backup.sh` for example. The file must be made executable:

```
chmod u+x backup.sh
```

Then from a terminal prompt:

```
sudo ./backup.sh
```

This is a great way to test the script to make sure everything works as expected.

### Executing with cron

The cron utility can be used to automate the script execution. The cron daemon allows the execution of scripts, or commands, at a specified time and date.

cron is configured through entries in a `crontab` file. `crontab` files are separated into fields:

```
m h dom mon dow command
```

- *m*: minute the command executes on, between 0 and 59.
- *h*: hour the command executes on, between 0 and 23.
- *dom*: day of month the command executes on.
- *mon*: the month the command executes on, between 1 and 12.
- *dow*: the day of the week the command executes on, between 0 and 7. Sunday may be specified by using 0 or 7, both values are valid.
- *command*: the command to execute.

To add or change entries in a `crontab` file the `crontab -e` command should be used. Also, the contents of a `crontab` file can be viewed using the `crontab -l` command.

To execute the `backup.sh` script listed above using cron. Enter the following from a terminal prompt:

```
sudo crontab -e
```

#### Note

Using `sudo` with the `crontab -e` command edits the `root` user's crontab. This is necessary if you are backing up directories only the root user has access to.

Add the following entry to the `crontab` file:

```
m h dom mon dow command
0 0 * * * bash /usr/local/bin/backup.sh
```

The `backup.sh` script will now be executed every day at 12:00 pm.

#### Note

The `backup.sh` script will need to be copied to the `/usr/local/bin/` directory in order for this entry to execute properly. The script can reside anywhere on the file system, simply change the script path appropriately.

For more in-depth `crontab` options see [References](#).

## Restoring from the Archive

Once an archive has been created it is important to test the archive. The archive can be tested by listing the files it contains, but the best test is to *restore* a file from the archive.

- To see a listing of the archive contents. From a terminal prompt type:

```
tar -tzvf /mnt/backup/host-Monday.tgz
```

- To restore a file from the archive to a different directory enter:

```
tar -xzvf /mnt/backup/host-Monday.tgz -C /tmp etc/hosts
```

The `-C` option to `tar` redirects the extracted files to the specified directory. The above example will extract the `/etc/hosts` file to `/tmp/etc/hosts`. `tar` recreates the directory structure that it contains.

Also, notice the leading `“/”` is left off the path of the file to restore.

- To restore all files in the archive enter the following:

```
cd /
sudo tar -xzvf /mnt/backup/host-Monday.tgz
```

### Note

This will overwrite the files currently on the file system.

## References

- For more information on shell scripting see the [Advanced Bash-Scripting Guide](#)
- The [CronHowto Wiki Page](#) contains details on advanced cron options.
- See the [GNU tar Manual](#) for more tar options.
- The Wikipedia [Backup Rotation Scheme](#) article contains information on other backup rotation schemes.
- The shell script uses `tar` to create the archive, but there many other command line utilities that can be used. For example:
  - [cpio](#): used to copy files to and from archives.
  - [dd](#): part of the `coreutils` package. A low level utility that can copy data from one format to another.
  - [rsnapshot](#): a file system snapshot utility used to create copies of an entire file system. Also check the [Tools - rsnapshot](#) for some information.
  - [rsync](#): a flexible utility used to create incremental copies of files.

`Rsnapshot` is an `rsync`-based filesystem snapshot utility. It can take incremental backups of local and remote filesystems for any number of machines. `Rsnapshot` makes extensive use of hard links, so disk space is only used when absolutely necessary. It leverages the power of `rsync` to create scheduled, incremental backups.

To install it open a terminal shell and run:

```
sudo apt-get install rsnapshot
```

If you want to backup a remote filesystem the `rsnapshot` server needs to be able to access the target machine over SSH without password. For more information on how to enable it please see [OpenSSH documentation](#). If the backup target is a local filesystem there is no need to set up OpenSSH.

## Configuration

The `rsnapshot` configuration resides in `/etc/rsnapshot.conf`. Below you can find some of the options available there.

The root directory where all snapshots will be stored:

```
snapshot_root /var/cache/rsnapshot/
```

How many old backups you would like to keep. Since `rsnapshot` uses incremental backups, we can afford to keep older backups for awhile before removing them. You set these up under the `BACKUP LEVELS / INTERVALS` section. You tell `rsnapshot` to retain a specific number of backups of each kind of interval.

```
retain daily 6
retain weekly 7
retain monthly 4
```

In this example we will keep 6 snapshots of our daily strategy, 7 snapshots of our weekly strategy, and 4 snapshots of our monthly strategy. These data will guide the rotation made by `rsnapshot`.

If you are accessing a remote machine over SSH and the port to bind is not the default (port 22), you need to set the following variable with the port number:

```
ssh_args -p 22222
```

And the most important part, you need to decide on what you would like to backup. If you are backing up locally to the same machine, this is as easy as specifying the directories that you want to save and following it with `localhost/` which will be a sub-directory in the `snapshot_root` that you set up earlier.

```
backup /home/ localhost/
backup /etc/ localhost/
backup /usr/local/ localhost/
```

If you are backing up a remote machine you just need to tell `rsnapshot` where the server is and which directories you would like to back up.

```
backup root@example.com:/home/ example.com/ +rsync_long_args=--bwlimit=16,exclude=core
backup root@example.com:/etc/ example.com/ exclude=mtab,exclude=core
```

As you can see you can see you can pass extra `rsync` parameters (the `+` append the parameter to the default list, if you remove the `+` sign you override it) and also exclude directories.

You can check the comments in `/etc/rsnapshot.conf` and the [rsnapshot man page](#) for more options.

## Test Configuration

After modifying the configuration file is a good practice to check if the syntax is ok:

```
sudo rsnapshot configtest
```

You can also test your backup levels with the following command:

```
sudo rsnapshot -t daily
```

If you are happy with the output and want to see it in action you can run:

```
sudo rsnapshot daily
```

## Scheduling Backups

With `rsnapshot` working correctly with the current configuration, the only thing left to do is to schedule it to run at certain intervals. We will use `cron` to make this happen since `rsnapshot` includes a default `cron` file in `/etc/cron.d/rsnapshot`. If you open this file there are some entries commented out as reference.

```
0 4 * * * root /usr/bin/rsnapshot daily
0 3 * * 1 root /usr/bin/rsnapshot weekly
0 2 1 * * root /usr/bin/rsnapshot monthly
```

The settings above added to `/etc/cron.d/rsnapshot` run:

- the **daily snapshot** everyday at 4:00 am
- the **weekly snapshot** every Monday at 3:00 am
- the **monthly snapshot** on the first of every month at 2:00 am

For more information on how to schedule a backup using `cron` please take a look at [Executing with cron](#) section in [Backups - Shell Scripts](#).

## References

- [Rsnapshot official web page](#)
- [Rsnapshot man page](#)
- [Rsync man page](#)

The process of getting an email from one person to another over a network or the Internet involves many systems working together. Each of these systems must be correctly configured for the process to work. The sender uses a *Mail User Agent* (MUA), or email client, to send the message through one or more *Mail Transfer Agents* (MTA), the last of which will hand it off to a *Mail Delivery Agent* (MDA) for delivery to the recipient's mailbox, from which it will be retrieved by the recipient's email client, usually via a POP3 or IMAP server.

On Ubuntu, [Postfix](#) is the default, supported MTA.



Dovecot is a Mail Delivery Agent, written with security primarily in mind. It supports the major mailbox formats: mbox or Maildir. This section explains how to set it up as an IMAP or POP3 server.

## Installation

To install a basic Dovecot server with common POP3 and IMAP functions, run the following command:

```
sudo apt install dovecot-imapd dovecot-pop3d
```

There are various other Dovecot modules including dovecot-sieve (mail filtering), dovecot-solr (full text search), dovecot-antispam (spam filter training), dovecot-ldap (user directory).

## Configuration

To configure Dovecot, edit the file `/etc/dovecot/dovecot.conf` and its included config files in `/etc/dovecot/conf.d/`. By default all installed protocols will be enabled via an include directive in `/etc/dovecot/dovecot.conf`.

```
!include_try /usr/share/dovecot/protocols.d/*.protocol
```

IMAPS and POP3S are more secure because they use SSL encryption to connect. A basic self-signed ssl certificate is automatically set up by package `ssl-cert` and used by Dovecot in `/etc/dovecot/conf.d/10-ssl.conf`.

By default mbox format is configured, if required you can also use Maildir. More about that can be found in the comments in `/etc/dovecot/conf.d/10-mail.conf`. Also see [the Dovecot web site](#) to learn about further benefits and details.

Make sure to also configure your Mail Transport Agent (MTA) to transfer the incoming mail to the selected type of mailbox.

Once you have configured Dovecot, restart its daemon in order to test your setup:

```
sudo service dovecot restart
```

Try to log in with the commands `telnet localhost pop3` (for POP3) or `telnet localhost imap2` (for IMAP). You should see something like the following:

```
bhuvan@rainbow:~$ telnet localhost pop3
Trying 127.0.0.1...
Connected to localhost.localdomain.
Escape character is '^]'.
+OK Dovecot ready.
```

## Dovecot SSL Configuration

Dovecot is configured to use SSL automatically by default, using the package `ssl-cert` which provides a self signed certificate.

You can instead generate your own custom certificate for Dovecot using `openssl`, for example:

```
sudo openssl req -new -x509 -days 1000 -nodes -out "/etc/dovecot/dovecot.pem" \
-keyout "/etc/dovecot/private/dovecot.pem"
```

See [certificates-and-security](#) for more details on creating custom certificates.

Then edit `/etc/dovecot/conf.d/10-ssl.conf` and amend following lines to specify Dovecot use these custom certificates:

```
ssl_cert = </etc/dovecot/private/dovecot.pem
ssl_key = </etc/dovecot/private/dovecot.key
```

You can get the SSL certificate from a Certificate Issuing Authority or you can create self-signed one (see [certificates-and-security](#) for details). Once you create the certificate, you will have a key file and a certificate file that you want to make known in the config shown above.

## Firewall Configuration for an Email Server

To access your mail server from another computer, you must configure your firewall to allow connections to the server on the necessary ports.

- IMAP - 143
- IMAPS - 993

- POP3 - 110
- POP3S - 995

## References

- See the [Dovecot website](#) for more information.
- Also, the [Dovecot Ubuntu Wiki](#) page has more details.

Exim4 is a Message Transfer Agent (MTA) developed at the University of Cambridge for use on Unix systems connected to the Internet. Exim can be installed in place of sendmail, although its configuration is quite different.

## Installation

To install exim4, run the following command:

```
sudo apt install exim4
```

## Configuration

To configure Exim4, run the following command:

```
sudo dpkg-reconfigure exim4-config
```

This displays a user interface “wizard” for configuring the software. For example, in Exim4 the configuration files are split among multiple files; if you wish to have them in one file you can configure accordingly via this user interface.

All the configurable parameters from the user interface are stored in `/etc/exim4/update-exim4.conf.conf` file, so to re-configure you can either re-run the wizard or manually edit this file using your favorite editor. Once you are finished, you can run the following command to generate the master configuration file:

```
sudo update-exim4.conf
```

The master configuration file is stored in `/var/lib/exim4/config.autogenerated`.

### Warning

At any time, you should not manually edit the master configuration file, `/var/lib/exim4/config.autogenerated`, because it is updated automatically every time you run `update-exim4.conf`, so your changes will risk being accidentally lost during a future update.

The following command will start the Exim4 daemon:

```
sudo service exim4 start
```

## SMTP Authentication

Exim4 can be configured to use SMTP-AUTH with TLS and SASL.

First, enter the following into a terminal prompt to create a certificate for use with TLS:

```
sudo /usr/share/doc/exim4-base/examples/exim-gencert
```

Configure Exim4 for TLS by editing `/etc/exim4/conf.d/main/03_exim4-config_tlsoptions` and adding the following:

```
MAIN_TLS_ENABLE = yes
```

Second, configure Exim4 to use the `saslauthd` for authentication by editing `/etc/exim4/conf.d/auth/30_exim4-config_examples` and uncomment the `plain_saslauthd_server` and `login_saslauthd_server` sections:

```
plain_saslauthd_server:
 driver = plaintext
 public_name = PLAIN
 server_condition = ${if saslauthd{${auth2}${auth3}}{1}{0}}
 server_set_id = $auth2
 server_prompts = :
 .ifndef AUTH_SERVER_ALLOW_NOTLS_PASSWORDS
 server_advertise_condition = ${if eq{${tls_cipher}}{}}{*}}
 .endif
#
login_saslauthd_server:
 driver = plaintext
```

```

public_name = LOGIN
server_prompts = "Username:: : Password::"
don't send system passwords over unencrypted connections
server_condition = ${if saslauthd{${auth1}${auth2}}{1}{0}}
server_set_id = $auth1
.ifndef AUTH_SERVER_ALLOW_NOTLS_PASSWORDS
server_advertise_condition = ${if eq{${tls_cipher}}{}}{*}}
.endif

```

Additionally, to enable outside mail clients to connect to the new server, a new user needs to be added into exim by using the following commands.

```
sudo /usr/share/doc/exim4-base/examples/exim-adduser
```

Protect the new password files with the following commands:

```
sudo chown root:Debian-exim /etc/exim4/passwd
sudo chmod 640 /etc/exim4/passwd
```

Finally, update the Exim4 configuration and restart the service:

```
sudo update-exim4.conf
sudo systemctl restart exim4.service
```

## Configuring SASL

To configure the saslauthd to provide authentication for Exim4, first install the sasl2-bin package by running this command at a terminal prompt:

```
sudo apt install sasl2-bin
```

To configure saslauthd, edit the `/etc/default/saslauthd` configuration file and set:

```
START=yes
```

Next, to make Exim4 use the saslauthd service, the *Debian-exim* user needs to be part of the *sasl* group:

```
sudo adduser Debian-exim sasl
```

Finally, start the saslauthd service:

```
sudo service saslauthd start
```

Exim4 is now configured with SMTP-AUTH using TLS and SASL authentication.

## References

- See [exim.org](http://exim.org) for more information.
- Another resource is the [Exim4 Ubuntu Wiki](#) page.
- Further resources to [set up mailman3 with exim4](#)

Postfix is the default Mail Transfer Agent (MTA) in Ubuntu. It attempts to be fast and secure, with flexibility in administration. It is compatible with the MTA sendmail. This section will explain installation, including how to configure SMTP for secure communications.

### Note

This guide does not cover setting up Postfix *Virtual Domains*, for information on Virtual Domains and other advanced configurations see [References](#).

## Installation

To install Postfix run the following command:

```
sudo apt install postfix
```

For now, it is ok to simply accept defaults by pressing return for each question. Some of the configuration options will be investigated in greater detail in the next stage.

**Deprecation warning:** please note that the `mail-stack-delivery` metapackage has been deprecated in Focal. The package still exists for compatibility reasons, but won't setup a working email system.

## Basic Configuration

There are four things you should decide before starting configuration:

- The <Domain> for which you'll accept email (we'll use `mail.example.com` in our example)
- The network and class range of your mail server (we'll use `192.168.0.0/24`)
- The username (we're using `steve`)
- Type of mailbox format (`mbx` is default, we'll use the alternative, `Maildir`)

To configure postfix, run the following command:

```
sudo dpkg-reconfigure postfix
```

The user interface will be displayed. On each screen, select the following values:

- Internet Site
- `mail.example.com`
- `steve`
- `mail.example.com, localhost.localdomain, localhost`
- No
- `127.0.0.0/8 [::ffff:127.0.0.0]/104 [::1]/128 192.168.0.0/24`
- 0
- +
- all

To set the mailbox format, you can either edit the configuration file directly, or use the `postconf` command. In either case, the configuration parameters will be stored in `/etc/postfix/main.cf` file. Later if you wish to re-configure a particular parameter, you can either run the command or change it manually in the file.

To configure the mailbox format for **Maildir**:

```
sudo postconf -e 'home_mailbox = Maildir/'
```

### Note

This will place new mail in `/home/username/Maildir` so you will need to configure your Mail Delivery Agent (MDA) to use the same path.

## SMTP Authentication

SMTP-AUTH allows a client to identify itself through the SASL authentication mechanism, using Transport Layer Security (TLS) to encrypt the authentication process. Once authenticated the SMTP server will allow the client to relay mail.

To configure Postfix for SMTP-AUTH using SASL (Dovecot SASL), run these commands at a terminal prompt:

```
sudo postconf -e 'smtpd_sasl_type = dovecot'
sudo postconf -e 'smtpd_sasl_path = private/auth'
sudo postconf -e 'smtpd_sasl_local_domain ='
sudo postconf -e 'smtpd_sasl_security_options = noanonymous,noplaintext'
sudo postconf -e 'smtpd_sasl_tls_security_options = noanonymous'
sudo postconf -e 'broken_sasl_auth_clients = yes'
sudo postconf -e 'smtpd_sasl_auth_enable = yes'
sudo postconf -e 'smtpd_recipient_restrictions = \
permit_sasl_authenticated,permit_mynetworks,reject_unauth_destination'
```

### Note

The `smtpd_sasl_path` config parameter is a path relative to the Postfix queue directory.

There are several SASL mechanism properties worth evaluating to improve the security of your deployment. The options “noanonymous,noplaintext” prevent use of mechanisms that permit anonymous authentication or that transmit credentials unencrypted.

Next, generate or obtain a digital certificate for TLS. See [security - certificates](#) in this guide for details about generating digital certificates and setting up your own Certificate Authority (CA).

### Note

MUAs connecting to your mail server via TLS will need to recognize the certificate used for TLS. This can either be done using a certificate from Let's Encrypt, from a commercial CA or with a self-signed certificate that users manually install/accept. For MTA to MTA TLS certificates are never validated without advance

agreement from the affected organizations. For MTA to MTA TLS, unless local policy requires it, there is no reason not to use a self-signed certificate. Refer to [security - certificates](#) in this guide for more details.

Once you have a certificate, configure Postfix to provide TLS encryption for both incoming and outgoing mail:

```
sudo postconf -e 'smtp_tls_security_level = may'
sudo postconf -e 'smtpd_tls_security_level = may'
sudo postconf -e 'smtp_tls_note_starttls_offer = yes'
sudo postconf -e 'smtpd_tls_key_file = /etc/ssl/private/server.key'
sudo postconf -e 'smtpd_tls_cert_file = /etc/ssl/certs/server.crt'
sudo postconf -e 'smtpd_tls_loglevel = 1'
sudo postconf -e 'smtpd_tls_received_header = yes'
sudo postconf -e 'myhostname = mail.example.com'
```

If you are using your own *Certificate Authority* to sign the certificate enter:

```
sudo postconf -e 'smtpd_tls_CAfile = /etc/ssl/certs/cacert.pem'
```

Again, for more details about certificates see [security - certificates](#) in this guide.

### Note

After running all the commands, Postfix is configured for SMTP-AUTH and a self-signed certificate has been created for TLS encryption.

Now, the file `/etc/postfix/main.cf` should look like this:

```
See /usr/share/postfix/main.cf.dist for a commented, more complete
version

smtpd_banner = $myhostname ESMTP $mail_name (Ubuntu)
biff = no

appending .domain is the MUA's job.
append_dot_mydomain = no

Uncomment the next line to generate "delayed mail" warnings
#delay_warning_time = 4h

myhostname = server1.example.com
alias_maps = hash:/etc/aliases
alias_database = hash:/etc/aliases
myorigin = /etc/mailname
mydestination = server1.example.com, localhost.example.com, localhost
relayhost =
mynetworks = 127.0.0.0/8
mailbox_command = procmail -a "$EXTENSION"
mailbox_size_limit = 0
recipient_delimiter = +
inet_interfaces = all
smtpd_sasl_local_domain =
smtpd_sasl_auth_enable = yes
smtpd_sasl_security_options = noanonymous
broken_sasl_auth_clients = yes
smtpd_recipient_restrictions =
permit_sasl_authenticated,permit_mynetworks,reject_unauth_destination
smtpd_tls_auth_only = no
smtp_tls_security_level = may
smtpd_tls_security_level = may
smtp_tls_note_starttls_offer = yes
smtpd_tls_key_file = /etc/ssl/private/smtpd.key
smtpd_tls_cert_file = /etc/ssl/certs/smtpd.crt
smtpd_tls_CAfile = /etc/ssl/certs/cacert.pem
smtpd_tls_loglevel = 1
smtpd_tls_received_header = yes
smtpd_tls_session_cache_timeout = 3600s
tls_random_source = dev:/dev/urandom
```

The postfix initial configuration is complete. Run the following command to restart the postfix daemon:

```
sudo systemctl restart postfix.service
```

Postfix supports SMTP-AUTH as defined in [RFC2554](#). It is based on [SASL](#). However it is still necessary to set up SASL authentication before you can use SMTP-AUTH.

When using ipv6, the mynetworks parameter may need to be modified to allow ipv6 addresses, for example:

```
mynetworks = 127.0.0.0/8, [::1]/128
```

## Configuring SASL

Postfix supports two SASL implementations: *Cyrus SASL* and *Dovecot SASL*. To enable Dovecot SASL the dovecot-core package will need to be installed:

```
sudo apt install dovecot-core
```

Next, edit `/etc/dovecot/conf.d/10-master.conf` and change the following:

```
service auth {
 # auth_socket_path points to this userdb socket by default. It's typically
 # used by dovecot-lda, doveadm, possibly imap process, etc. Its default
 # permissions make it readable only by root, but you may need to relax these
 # permissions. Users that have access to this socket are able to get a list
 # of all usernames and get results of everyone's userdb lookups.
 unix_listener auth-userdb {
 #mode = 0600
 #user =
 #group =
 }

 # Postfix smtp-auth
 unix_listener /var/spool/postfix/private/auth {
 mode = 0660
 user = postfix
 group = postfix
 }
}
```

To permit use of SMTP-AUTH by Outlook clients, change the following line in the *authentication mechanisms* section of `/etc/dovecot/conf.d/10-auth.conf` from:

```
auth_mechanisms = plain
```

to this:

```
auth_mechanisms = plain login
```

Once you have Dovecot configured, restart it with:

```
sudo systemctl restart dovecot.service
```

## Testing

SMTP-AUTH configuration is complete. Now it is time to test the setup.

To see if SMTP-AUTH and TLS work properly, run the following command:

```
telnet mail.example.com 25
```

After you have established the connection to the Postfix mail server, type:

```
ehlo mail.example.com
```

If you see the following in the output, then everything is working perfectly. Type `quit` to exit.

```
250-STARTTLS
250-AUTH LOGIN PLAIN
250-AUTH=LOGIN PLAIN
250 8BITMIME
```

## Troubleshooting

When problems arise, there are a few common ways to diagnose the cause.

### Escaping chroot

The Ubuntu Postfix package will by default install into a *chroot* environment for security reasons. This can add greater complexity when troubleshooting problems.

To turn off the chroot usage, locate the following line in the `/etc/postfix/master.cf` configuration file:

```
smtp inet n - - - smtpd
```

and modify it as follows:

```
smtp inet n - n - smtpd
```

You will then need to restart Postfix to use the new configuration. From a terminal prompt enter:

```
sudo service postfix restart
```

### SMTPS

If you need secure SMTP, edit `/etc/postfix/master.cf` and uncomment the following line:

```
smtps inet n - - - smtpd
-o smtpd_tls_wrappermode=yes
-o smtpd_sasl_auth_enable=yes
-o smtpd_client_restrictions=permit_sasl_authenticated,reject
-o milter_macro_daemon_name=ORIGINATING
```

### Log Viewing

Postfix sends all log messages to `/var/log/mail.log`. However, error and warning messages can sometimes get lost in the normal log output so they are also logged to `/var/log/mail.err` and `/var/log/mail.warn` respectively.

To see messages entered into the logs in real time you can use the `tail -f` command:

```
tail -f /var/log/mail.err
```

### Increasing Logging Detail

The amount of detail that is recorded in the logs can be increased via the configuration options. For example, to increase *TLS* activity logging set the `smtpd_tls_loglevel` option to a value from 1 to 4.

```
sudo postconf -e 'smtpd_tls_loglevel = 4'
```

Reload the service after any configuration change, to make the new config active:

```
sudo systemctl reload postfix.service
```

### Logging mail delivery

If you are having trouble sending or receiving mail from a specific domain you can add the domain to the `debug_peer_list` parameter.

```
sudo postconf -e 'debug_peer_list = problem.domain'
sudo systemctl reload postfix.service
```

### Increasing daemon verbosity

You can increase the verbosity of any Postfix daemon process by editing the `/etc/postfix/master.cf` and adding a `-v` after the entry. For example, edit the `smtp` entry:

```
smtp unix - - - - - smtp -v
```

Then, reload the service as usual:

```
sudo systemctl reload postfix.service
```

## Logging SASL debug info

To increase the amount of information logged when troubleshooting *SASL* issues you can set the following options in `/etc/dovecot/conf.d/10-logging.conf`

```
auth_debug=yes
auth_debug_passwords=yes
```

Just like Postfix if you change a Dovecot configuration the process will need to be reloaded:

```
sudo systemctl reload dovecot.service
```

### Note

Some of the options above can drastically increase the amount of information sent to the log files. Remember to return the log level back to normal after you have corrected the problem. Then reload the appropriate daemon for the new configuration to take affect.

## References

Administering a Postfix server can be a very complicated task. At some point you may need to turn to the Ubuntu community for more experienced help.

- The [Postfix website](#) documents all available configuration options.
- O'Reilly's [Postfix: The Definitive Guide](#) is rather dated but provides deep background information about configuration options.
- The [Ubuntu Wiki Postfix](#) page has more information from a Ubuntu context. There is also a [Debian Wiki Postfix](#) page that's a bit more up to date; they also have a set of [Postfix Tutorials](#) for different Debian versions.
- Info on how to [set up mailman3 with postfix](#)

The primary function of a web server is to store, process and deliver Web pages to clients. The clients communicate with the server sending HTTP requests. Clients, mostly via Web Browsers, request for a specific resources and the server responds with the content of that resource or an error message. The response is usually a Web page such as HTML documents which may include images, style sheets, scripts, and the content in form of text.

When accessing a Web Server, every HTTP request that is received is responded to with a content and a HTTP status code. HTTP status codes are three-digit codes, and are grouped into five different classes. The class of a status code can be quickly identified by its first digit:

- **1xx** : *Informational* - Request received, continuing process
- **2xx** : *Success* - The action was successfully received, understood, and accepted
- **3xx** : *Redirection* - Further action must be taken in order to complete the request
- **4xx** : *Client Error* - The request contains bad syntax or cannot be fulfilled
- **5xx** : *Server Error* - The server failed to fulfill an apparently valid request

More information about status code check the [RFC 2616](#).

## Implementation

Web Servers are heavily used in the deployment of Web sites and in this scenario we can use two different implementations:

- **Static Web Server**: The content of the server's response will be the hosted files "as-is".
- **Dynamic Web Server**: Consist in a Web Server plus an extra software, usually an *application server* and a *database*. For example, to produce the Web pages you see in the Web browser, the application server might fill an HTML template with contents from a database. Due to that we say that the content of the server's response is generated dynamically.

Apache is the most commonly used Web server on Linux systems. Web servers are used to serve Web pages requested by client computers. Clients typically request and view Web pages using Web browser applications such as Firefox, Opera, Chromium, or Internet Explorer.

Users enter a Uniform Resource Locator (URL) to point to a Web server by means of its Fully Qualified Domain Name (FQDN) and a path to the required resource. For example, to view the home page of the [Ubuntu Web site](#) a user will enter only the FQDN:

```
www.ubuntu.com
```

To view the [community](#) sub-page, a user will enter the FQDN followed by a path:

```
www.ubuntu.com/community
```



The most common protocol used to transfer Web pages is the Hyper Text Transfer Protocol (HTTP). Protocols such as Hyper Text Transfer Protocol over Secure Sockets Layer (HTTPS), and File Transfer Protocol (FTP), a protocol for uploading and downloading files, are also supported.

Apache Web Servers are often used in combination with the MySQL database engine, the HyperText Preprocessor (PHP) scripting language, and other popular scripting languages such as Python and Perl. This configuration is termed LAMP (Linux, Apache, MySQL and Perl/Python/PHP) and forms a powerful and robust platform for the development and deployment of Web-based applications.

## Installation

The Apache2 web server is available in Ubuntu Linux. To install Apache2:

At a terminal prompt enter the following command:

```
sudo apt install apache2
```

## Configuration

Apache2 is configured by placing *directives* in plain text configuration files. These *directives* are separated between the following files and directories:

- *apache2.conf*: the main Apache2 configuration file. Contains settings that are *global* to Apache2.
- *httpd.conf*: historically the main Apache2 configuration file, named after the httpd daemon. In other distributions (or older versions of Ubuntu), the file might be present. In Ubuntu, all configuration options have been moved to *apache2.conf* and the below referenced directories, and this file no longer exists.
- *conf-available*: this directory contains available configuration files. All files that were previously in */etc/apache2/conf.d* should be moved to */etc/apache2/conf-available*.
- *conf-enabled*: holds *symlinks* to the files in */etc/apache2/conf-available*. When a configuration file is symlinked, it will be enabled the next time apache2 is restarted.
- *envvars*: file where Apache2 *environment* variables are set.
- *mods-available*: this directory contains configuration files to both load *modules* and configure them. Not all modules will have specific configuration files, however.
- *mods-enabled*: holds *symlinks* to the files in */etc/apache2/mods-available*. When a module configuration file is symlinked it will be enabled the next time apache2 is restarted.
- *ports.conf*: houses the directives that determine which TCP ports Apache2 is listening on.
- *sites-available*: this directory has configuration files for Apache2 *Virtual Hosts*. Virtual Hosts allow Apache2 to be configured for multiple sites that have separate configurations.
- *sites-enabled*: like *mods-enabled*, *sites-enabled* contains symlinks to the */etc/apache2/sites-available* directory. Similarly when a configuration file in *sites-available* is symlinked, the site configured by it will be active once Apache2 is restarted.
- *magic*: instructions for determining MIME type based on the first few bytes of a file.

In addition, other configuration files may be added using the *Include* directive, and wildcards can be used to include many configuration files. Any directive may be placed in any of these configuration files. Changes to the main configuration files are only recognized by Apache2 when it is started or restarted.

The server also reads a file containing mime document types; the filename is set by the *TypesConfig* directive, typically via */etc/apache2/mods-available/mime.conf*, which might also include additions and overrides, and is */etc/mime.types* by default.

## Basic Settings

This section explains Apache2 server essential configuration parameters. Refer to the [Apache2 Documentation](#) for more details.

- Apache2 ships with a virtual-host-friendly default configuration. That is, it is configured with a single default virtual host (using the *VirtualHost* directive) which can be modified or used as-is if you have a single site, or used as a template for additional virtual hosts if you have multiple sites. If left alone, the default virtual host will serve as your default site, or the site users will see if the URL they enter does not match the *ServerName* directive of any of your custom sites. To modify the default virtual host, edit the file */etc/apache2/sites-available/000-default.conf*.

## Note

The directives set for a virtual host only apply to that particular virtual host. If a directive is set server-wide and not defined within the virtual host settings, the default setting is used. For example, you can define a Webmaster email address and not define individual email addresses for each virtual host.

If you wish to configure a new virtual host or site, copy that file into the same directory with a name you choose. For example:

```
sudo cp /etc/apache2/sites-available/000-default.conf /etc/apache2/sites-available/mynewsite.conf
```

Edit the new file to configure the new site using some of the directives described below.

- The *ServerAdmin* directive specifies the email address to be advertised for the server's administrator. The default value is `webmaster@localhost`. This should be changed to an email address that is delivered to you (if you are the server's administrator). If your website has a problem, Apache2 will display an error message containing this email address to report the problem to. Find this directive in your site's configuration file in `/etc/apache2/sites-available`.
- The *Listen* directive specifies the port, and optionally the IP address, Apache2 should listen on. If the IP address is not specified, Apache2 will listen on all IP addresses assigned to the machine it runs on. The default value for the *Listen* directive is 80. Change this to `127.0.0.1:80` to cause Apache2 to listen only on your loopback interface so that it will not be available to the Internet, to (for example) 81 to change the port that it listens on, or leave it as is for normal operation. This directive can be found and changed in its own file, `/etc/apache2/ports.conf`
- The *ServerName* directive is optional and specifies what FQDN your site should answer to. The default virtual host has no *ServerName* directive specified, so it will respond to all requests that do not match a *ServerName* directive in another virtual host. If you have just acquired the domain name `mynewsite.com` and wish to host it on your Ubuntu server, the value of the *ServerName* directive in your virtual host configuration file should be `mynewsite.com`. Add this directive to the new virtual host file you created earlier (`/etc/apache2/sites-available/mynewsite.conf`).

You may also want your site to respond to `www.mynewsite.com`, since many users will assume the `www` prefix is appropriate. Use the *ServerAlias* directive for this. You may also use wildcards in the *ServerAlias* directive.

For example, the following configuration will cause your site to respond to any domain request ending in `.mynewsite.com`.

```
ServerAlias *.mynewsite.com
```

- The *DocumentRoot* directive specifies where Apache2 should look for the files that make up the site. The default value is `/var/www/html`, as specified in `/etc/apache2/sites-available/000-default.conf`. If desired, change this value in your site's virtual host file, and remember to create that directory if necessary!

Enable the new *VirtualHost* using the `a2ensite` utility and restart Apache2:

```
sudo a2ensite mynewsite
sudo systemctl restart apache2.service
```

## Note

Be sure to replace `mynewsite` with a more descriptive name for the *VirtualHost*. One method is to name the file after the *ServerName* directive of the *VirtualHost*.

Similarly, use the `a2dissite` utility to disable sites. This can be useful when troubleshooting configuration problems with multiple *VirtualHosts*:

```
sudo a2dissite mynewsite
sudo systemctl restart apache2.service
```

## Default Settings

This section explains configuration of the Apache2 server default settings. For example, if you add a virtual host, the settings you configure for the virtual host take precedence for that virtual host. For a directive not defined within the virtual host settings, the default value is used.

- The *DirectoryIndex* is the default page served by the server when a user requests an index of a directory by specifying a forward slash (`/`) at the end of the directory name.

For example, when a user requests the page `http://www.example.com/this_directory/`, he or she will get either the *DirectoryIndex* page if it exists, a server-generated directory list if it does not and the *Indexes* option is specified, or a *Permission Denied* page if neither is true. The server will try to find one of the files listed in

the `DirectoryIndex` directive and will return the first one it finds. If it does not find any of these files and if `Options Indexes` is set for that directory, the server will generate and return a list, in HTML format, of the subdirectories and files in the directory. The default value, found in `/etc/apache2/mods-available/dir.conf` is “`index.html index.cgi index.pl index.php index.xhtml index.htm`”. Thus, if Apache2 finds a file in a requested directory matching any of these names, the first will be displayed.

- The `ErrorDocument` directive allows you to specify a file for Apache2 to use for specific error events. For example, if a user requests a resource that does not exist, a 404 error will occur. By default, Apache2 will simply return a HTTP 404 Return code. Read `/etc/apache2/conf-available/localized-error-pages.conf` for detailed instructions for using `ErrorDocument`, including locations of example files.
- By default, the server writes the transfer log to the file `/var/log/apache2/access.log`. You can change this on a per-site basis in your virtual host configuration files with the `CustomLog` directive, or omit it to accept the default, specified in `/etc/apache2/conf-available/other-vhosts-access-log.conf`. You may also specify the file to which errors are logged, via the `ErrorLog` directive, whose default is `/var/log/apache2/error.log`. These are kept separate from the transfer logs to aid in troubleshooting problems with your Apache2 server. You may also specify the `LogLevel` (the default value is “warn”) and the `LogFormat` (see `/etc/apache2/apache2.conf` for the default value).
- Some options are specified on a per-directory basis rather than per-server. `Options` is one of these directives. A `Directory` stanza is enclosed in XML-like tags, like so:

```
<Directory /var/www/html/mynewsite>
...
</Directory>
```

The `Options` directive within a `Directory` stanza accepts one or more of the following values (among others), separated by spaces:

- **ExecCGI** - Allow execution of CGI scripts. CGI scripts are not executed if this option is not chosen.

#### Caution

Most files should not be executed as CGI scripts. This would be very dangerous. CGI scripts should be kept in a directory separate from and outside your `DocumentRoot`, and only this directory should have the `ExecCGI` option set. This is the default, and the default location for CGI scripts is `/usr/lib/cgi-bin`.

- **Includes** - Allow server-side includes. Server-side includes allow an HTML file to *include* other files. See [Apache SSI documentation \(Ubuntu community\)](#) for more information.
- **IncludesNOEXEC** - Allow server-side includes, but disable the `#exec` and `#include` commands in CGI scripts.
- **Indexes** - Display a formatted list of the directory’s contents, if no `DirectoryIndex` (such as `index.html`) exists in the requested directory.

#### Caution

For security reasons, this should usually not be set, and certainly should not be set on your `DocumentRoot` directory. Enable this option carefully on a per-directory basis only if you are certain you want users to see the entire contents of the directory.

- **Multiview** - Support content-negotiated multiviews; this option is disabled by default for security reasons. See the [Apache2 documentation on this option](#).
- **SymLinksIfOwnerMatch** - Only follow symbolic links if the target file or directory has the same owner as the link.

## apache2 Settings

This section explains some basic apache2 daemon configuration settings.

**LockFile** - The `LockFile` directive sets the path to the lockfile used when the server is compiled with either `USE_FCNTL_SERIALIZED_ACCEPT` or `USE_FLOCK_SERIALIZED_ACCEPT`. It must be stored on the local disk. It should be left to the default value unless the logs directory is located on an NFS share. If this is the case, the default value should be changed to a location on the local disk and to a directory that is readable only by root.

**PidFile** - The `PidFile` directive sets the file in which the server records its process ID (pid). This file should only be readable by root. In most cases, it should be left to the default value.

**User** - The User directive sets the userid used by the server to answer requests. This setting determines the server's access. Any files inaccessible to this user will also be inaccessible to your website's visitors. The default value for User is "www-data".

### Warning

Unless you know exactly what you are doing, do not set the User directive to root. Using root as the User will create large security holes for your Web server.

**Group** - The Group directive is similar to the User directive. Group sets the group under which the server will answer requests. The default group is also "www-data".

## Apache2 Modules

Apache2 is a modular server. This implies that only the most basic functionality is included in the core server. Extended features are available through modules which can be loaded into Apache2. By default, a base set of modules is included in the server at compile-time. If the server is compiled to use dynamically loaded modules, then modules can be compiled separately, and added at any time using the LoadModule directive. Otherwise, Apache2 must be recompiled to add or remove modules.

Ubuntu compiles Apache2 to allow the dynamic loading of modules. Configuration directives may be conditionally included on the presence of a particular module by enclosing them in an `<IfModule>` block.

You can install additional Apache2 modules and use them with your Web server. For example, run the following command at a terminal prompt to install the Python 3 WSGI module:

```
sudo apt install libapache2-mod-wsgi-py3
```

The installation will enable the module automatically, but we can disable it with `a2dismod`:

```
sudo a2dismod wsgi
sudo systemctl restart apache2.service
```

And then use the `a2enmod` utility to re-enable it:

```
sudo a2enmod wsgi
sudo systemctl restart apache2.service
```

See the `/etc/apache2/mods-available` directory for additional modules already available on your system.

## HTTPS Configuration

The `mod_ssl` module adds an important feature to the Apache2 server - the ability to encrypt communications. Thus, when your browser is communicating using SSL, the `https://` prefix is used at the beginning of the Uniform Resource Locator (URL) in the browser navigation bar.

The `mod_ssl` module is available in `apache2-common` package. Execute the following command at a terminal prompt to enable the `mod_ssl` module:

```
sudo a2enmod ssl
```

There is a default HTTPS configuration file in `/etc/apache2/sites-available/default-ssl.conf`. In order for Apache2 to provide HTTPS, a *certificate* and *key* file are also needed. The default HTTPS configuration will use a certificate and key generated by the `ssl-cert` package. They are good for testing, but the auto-generated certificate and key should be replaced by a certificate specific to the site or server. For information on generating a key and obtaining a certificate see [Certificates](#).

To configure Apache2 for HTTPS, enter the following:

```
sudo a2ensite default-ssl
```

### Note

The directories `/etc/ssl/certs` and `/etc/ssl/private` are the default locations. If you install the certificate and key in another directory make sure to change `SSLCertificateFile` and `SSLCertificateKeyFile` appropriately.

With Apache2 now configured for HTTPS, restart the service to enable the new settings:

```
sudo systemctl restart apache2.service
```

### Note

Depending on how you obtained your certificate you may need to enter a passphrase when Apache2 starts.

You can access the secure server pages by typing `https://your_hostname/url/` in your browser address bar.

## Sharing Write Permission

For more than one user to be able to write to the same directory it will be necessary to grant write permission to a group they share in common. The following example grants shared write permission to `/var/www/html` to the group “webmasters”.

```
sudo chgrp -R webmasters /var/www/html
sudo chmod -R g=rwX /var/www/html/
```

These commands recursively set the group permission on all files and directories in `/var/www/html` to allow reading, writing and searching of directories. Many admins find this useful for allowing multiple users to edit files in a directory tree.

### Warning

The `apache2` daemon will run as the `www-data` user, which has a corresponding `www-data` group. These *should not* be granted write access to the document root, as this would mean that vulnerabilities in Apache or the applications it is serving would allow attackers to overwrite the served content.

## References

- [Apache2 Documentation](#) contains in depth information on Apache2 configuration directives. Also, see the `apache2-doc` package for the official Apache2 docs.
- O'Reilly's [Apache Cookbook](#) is a good resource for accomplishing specific Apache2 configurations.
- For Ubuntu specific Apache2 questions, ask in the `#ubuntu-server` IRC channel on [libera.chat](#).

Squid is a full-featured web proxy cache server application which provides proxy and cache services for Hyper Text Transport Protocol (HTTP), File Transfer Protocol (FTP), and other popular network protocols. Squid can implement caching and proxying of Secure Sockets Layer (SSL) requests and caching of Domain Name Server (DNS) lookups, and perform transparent caching. Squid also supports a wide variety of caching protocols, such as Internet Cache Protocol (ICP), the Hyper Text Caching Protocol (HTCP), the Cache Array Routing Protocol (CARP), and the Web Cache Coordination Protocol (WCCP).

The Squid proxy cache server is an excellent solution to a variety of proxy and caching server needs, and scales from the branch office to enterprise level networks while providing extensive, granular access control mechanisms, and monitoring of critical parameters via the Simple Network Management Protocol (SNMP). When selecting a computer system for use as a dedicated Squid caching proxy server for many users ensure it is configured with a large amount of physical memory as Squid maintains an in-memory cache for increased performance.

## Installation

At a terminal prompt, enter the following command to install the Squid server:

```
sudo apt install squid
```

## Configuration

Squid is configured by editing the directives contained within the `/etc/squid/squid.conf` configuration file. The following examples illustrate some of the directives which may be modified to affect the behavior of the Squid server. For more in-depth configuration of Squid, see the References section.

### Tip

Prior to editing the configuration file, you should make a copy of the original file and protect it from writing so you will have the original settings as a reference, and to re-use as necessary. Make this copy and protect it from writing using the following commands:

```
sudo cp /etc/squid/squid.conf /etc/squid/squid.conf.original
sudo chmod a-w /etc/squid/squid.conf.original
```

- To set your Squid server to listen on TCP port 8888 instead of the default TCP port 3128, change the `http_port` directive as such:

```
http_port 8888
```

- Change the `visible_hostname` directive in order to give the Squid server a specific hostname. This hostname does not necessarily need to be the computer's hostname. In this example it is set to `weezie`

```
visible_hostname weezie
```

- The `cache_dir` option allows one to configure an on-disk cache, the default option is on-memory cache. The `cache_dir` directive takes the following arguments:

```
cache_dir <Type> <Directory-Name> <Fs-specific-data> [options]
```

In the config file you can find the default `cache_dir` directive commented out:

```
Uncomment and adjust the following to add a disk cache directory.
#cache_dir ufs /var/spool/squid 100 16 256
```

You can just use the default option but you can also customize your cache directory, basically changing the `<Type>` of this directory, it can be:

- `ufs`: the old well-known Squid storage format that has always been there.
- `aufs`: uses the same storage format as `ufs`, utilizing POSIX-threads to avoid blocking the main Squid process on disk-I/O. This was formerly known in Squid as `async-io`.
- `diskd`: uses the same storage format as `ufs`, utilizing a separate process to avoid blocking the main Squid process on disk-I/O.
- `rock`: is a database-style storage. All cached entries are stored in a “database” file, using fixed-size slots. A single entry occupies one or more slots.

If you want to use a different directory type please take a look at their different options.

- Using Squid’s access control, you may configure use of Internet services proxied by Squid to be available only users with certain Internet Protocol (IP) addresses. For example, we will illustrate access by users of the 192.168.42.0/24 subnetwork only:

Add the following to the **bottom** of the ACL section of your `/etc/squid/squid.conf` file:

```
acl fortytwo_network src 192.168.42.0/24
```

Then, add the following to the **top** of the `http_access` section of your `/etc/squid/squid.conf` file:

```
http_access allow fortytwo_network
```

- Using the excellent access control features of Squid, you may configure use of Internet services proxied by Squid to be available only during normal business hours. For example, we’ll illustrate access by employees of a business which is operating between 9:00AM and 5:00PM, Monday through Friday, and which uses the 10.1.42.0/24 subnetwork:

Add the following to the **bottom** of the ACL section of your `/etc/squid/squid.conf` file:

```
acl biz_network src 10.1.42.0/24
acl biz_hours time M T W T F 9:00-17:00
```

Then, add the following to the **top** of the `http_access` section of your `/etc/squid/squid.conf` file:

```
http_access allow biz_network biz_hours
```

### Note

After making changes to the `/etc/squid/squid.conf` file, save the file and restart the squid server application to effect the changes using the following command entered at a terminal prompt:

```
sudo systemctl restart squid.service
```

### Note

If formerly a customized squid3 was used that set up the spool at `/var/log/squid3` to be a mountpoint, but otherwise kept the default configuration the upgrade will fail. The upgrade tries to rename/move files as needed, but it can’t do so for an active mountpoint. In that case please either adapt the mountpoint or the config in `/etc/squid/squid.conf` so that they match.

The same applies if the **include** config statement was used to pull in more files from the old path at `/etc/squid3/`. In those cases you should move and adapt your configuration accordingly.

## References

[Squid Website](#)

[Ubuntu Wiki Squid page.](#)

## Overview

LAMP installations (Linux + Apache + MySQL + PHP/Perl/Python) are a popular setup for Ubuntu servers. There is a plethora of Open Source applications written using the LAMP application stack. Some popular LAMP applications are Wiki's, Content Management Systems, and Management Software such as phpMyAdmin.

One advantage of LAMP is the substantial flexibility for different database, web server, and scripting languages. Popular substitutes for MySQL include PostgreSQL and SQLite. Python, Perl, and Ruby are also frequently used instead of PHP. While Nginx, Cherokee and Lighttpd can replace Apache.

The fastest way to get started is to install LAMP using tasksel. Tasksel is a Debian/Ubuntu tool that installs multiple related packages as a co-ordinated “task” onto your system. To install a LAMP server:

At a terminal prompt enter the following command:

```
sudo tasksel install lamp-server
```

After installing it you'll be able to install most *LAMP* applications in this way:

- Download an archive containing the application source files.
- Unpack the archive, usually in a directory accessible to a web server.
- Depending on where the source was extracted, configure a web server to serve the files.
- Configure the application to connect to the database.
- Run a script, or browse to a page of the application, to install the database needed by the application.
- Once the steps above, or similar steps, are completed you are ready to begin using the application.

A disadvantage of using this approach is that the application files are not placed in the file system in a standard way, which can cause confusion as to where the application is installed. Another larger disadvantage is updating the application. When a new version is released, the same process used to install the application is needed to apply updates.

Fortunately, a number of *LAMP* applications are already packaged for Ubuntu, and are available for installation in the same way as non-LAMP applications. Depending on the application some extra configuration and setup steps may be needed, however.

This section covers how to install some *LAMP* applications.

## phpMyAdmin

phpMyAdmin is a LAMP application specifically written for administering MySQL servers. Written in PHP, and accessed through a web browser, phpMyAdmin provides a graphical interface for database administration tasks.

### Installation

Before installing phpMyAdmin you will need access to a MySQL database either on the same host as that phpMyAdmin is installed on, or on a host accessible over the network. For more information see [MySQL documentation](#). From a terminal prompt enter:

```
sudo apt install phpmyadmin
```

At the prompt choose which web server to be configured for phpMyAdmin. The rest of this section will use Apache2 for the web server.

In a browser go to <http://servername/phpmyadmin>, replacing *servername* with the server's actual hostname. At the login, page enter *root* for the *username*, or another MySQL user, if you have any setup, and enter the MySQL user's password.

Once logged in you can reset the *root* password if needed, create users, create/destroy databases and tables, etc.

### Configuration

The configuration files for phpMyAdmin are located in `/etc/phpmyadmin`. The main configuration file is `/etc/phpmyadmin/config.inc.php`. This file contains configuration options that apply globally to phpMyAdmin.

To use phpMyAdmin to administer a MySQL database hosted on another server, adjust the following in `/etc/phpmyadmin/config.inc.php`:

```
$cfg['Servers'][$i]['host'] = 'db_server';
```

## Note

Replace *db\_server* with the actual remote database server name or IP address. Also, be sure that the phpMyAdmin host has permissions to access the remote database.

Once configured, log out of phpMyAdmin and back in, and you should be accessing the new server.

The `config.header.inc.php` and `config.footer.inc.php` files in `/etc/phpmyadmin` directory are used to add a HTML header and footer to phpMyAdmin.

Another important configuration file is `/etc/phpmyadmin/apache.conf`, this file is symlinked to `/etc/apache2/conf-available/phpmyadmin.conf`, and, once enabled, is used to configure Apache2 to serve the phpMyAdmin site. The file contains directives for loading PHP, directory permissions, etc. From a terminal type:

```
sudo ln -s /etc/phpmyadmin/apache.conf /etc/apache2/conf-available/phpmyadmin.conf
sudo a2enconf phpmyadmin.conf
sudo systemctl reload apache2.service
```

For more information on configuring Apache2 see this [documentation](#).

## References

- The phpMyAdmin documentation comes installed with the package and can be accessed from the *phpMyAdmin Documentation* link (a question mark with a box around it) under the phpMyAdmin logo. The official docs can also be access on the [phpMyAdmin](#) site.
- Another resource is the [phpMyAdmin Ubuntu Wiki](#) page.

## WordPress

Wordpress is a blog tool, publishing platform and CMS implemented in PHP and licensed under the GNU GPLv2.

### Installation

To install WordPress, run the following comand in the command prompt:

```
sudo apt install wordpress
```

You should also install apache2 web server and mysql server. For installing apache2 web server, please refer to [MySQL documentation](#).

### Configuration

For configuring your first WordPress application, configure an apache site. Open `/etc/apache2/sites-available/wordpress.conf` and write the following lines:

```
Alias /blog /usr/share/wordpress
<Directory /usr/share/wordpress>
 Options FollowSymLinks
 AllowOverride Limit Options FileInfo
 DirectoryIndex index.php
 Order allow,deny
 Allow from all
</Directory>
<Directory /usr/share/wordpress/wp-content>
 Options FollowSymLinks
 Order allow,deny
 Allow from all
</Directory>
```

Enable this new WordPress site

```
sudo a2ensite wordpress
```

Once you configure the apache2 web server and make it ready for your WordPress application, you should restart it. You can run the following command to restart the apache2 web server:

```
sudo systemctl reload apache2.service
```



To facilitate multiple WordPress installations, the name of this configuration file is based on the Host header of the HTTP request. This means that you can have a configuration per VirtualHost by simply matching the host-name portion of this configuration with your Apache Virtual Host. e.g. `/etc/wordpress/config-10.211.55.50.php`, `/etc/wordpress/config-hostalias1.php`, etc. These instructions assume you can access Apache via the localhost host-name (perhaps by using an ssh tunnel) if not, replace `/etc/wordpress/config-localhost.php` with `/etc/wordpress/config-NAME_OF_YOUR_VIRTUAL_HOST.php`.

Once the configuration file is written, it is up to you to choose a convention for username and password to mysql for each WordPress database instance. This documentation shows only one, localhost, example.

Now configure WordPress to use a mysql database. Open `/etc/wordpress/config-localhost.php` file and write the following lines:

```
<?php
define('DB_NAME', 'wordpress');
define('DB_USER', 'wordpress');
define('DB_PASSWORD', 'yourpasswordhere');
define('DB_HOST', 'localhost');
define('WP_CONTENT_DIR', '/usr/share/wordpress/wp-content');
?>
```

Now create this mysql database. Open a temporary file with mysql commands `wordpress.sql` and write the following lines:

```
CREATE DATABASE wordpress;
CREATE USER 'wordpress'@'localhost'
IDENTIFIED BY 'yourpasswordhere';
GRANT SELECT,INSERT,UPDATE,DELETE,CREATE,DROP,ALTER
ON wordpress.*
TO wordpress@localhost;
FLUSH PRIVILEGES;
```

Execute these commands.

```
cat wordpress.sql | sudo mysql --defaults-extra-file=/etc/mysql/debian.cnf
```

Your new WordPress can now be configured by visiting <http://localhost/blog/wp-admin/install.php>. (Or [http://NAME\\_OF\\_YOUR\\_VIRTUAL\\_HOST/blog/wp-admin/install.php](http://NAME_OF_YOUR_VIRTUAL_HOST/blog/wp-admin/install.php) if your server has no GUI and you are completing WordPress configuration via a web browser running on another computer.) Fill out the Site Title, username, password, and E-mail and click Install WordPress.

Note the generated password (if applicable) and click the login password. Your WordPress is now ready for use.

## References

- [WordPress.org Codex](#)
- [Ubuntu Wiki WordPress](#)

PHP is a general-purpose scripting language suited for Web development. PHP scripts can be embedded into HTML. This section explains how to install and configure PHP in an Ubuntu System with Apache2 and MySQL.

This section assumes you have installed and configured Apache2 Web Server and MySQL Database Server. You can refer to the Apache2 and MySQL sections in this document to install and configure Apache2 and MySQL respectively.

## Installation

PHP is available in Ubuntu Linux. Unlike Python, which is installed in the base system, PHP must be added.

To install PHP and the Apache PHP module you can enter the following command at a terminal prompt:

```
sudo apt install php libapache2-mod-php
```

You can run PHP scripts at a terminal prompt. To run PHP scripts at a terminal prompt you should install the `php-cli` package. To install `php-cli` you can enter the following command:

```
sudo apt install php-cli
```

You can also execute PHP scripts without installing the Apache PHP module. To accomplish this, you should install the `php-cgi` package via this command:

```
sudo apt install php-cgi
```

To use MySQL with PHP you should install the `php-mysql` package, like so:

```
sudo apt install php-mysql
```

Similarly, to use PostgreSQL with PHP you should install the `php-pgsql` package:

```
sudo apt install php-pgsql
```

## Configuration

If you have installed the `libapache2-mod-php` or `php-cgi` packages, you can run PHP scripts from your web browser. If you have installed the `php-cli` package, you can run PHP scripts at a terminal prompt.

By default, when `libapache2-mod-php` is installed, the Apache 2 Web server is configured to run PHP scripts using this module. Please verify if the files `/etc/apache2/mods-enabled/php8.*.conf` and `/etc/apache2/mods-enabled/php8.*.load` exist. If they do not exist, you can enable the module using the `a2enmod` command.

Once you have installed the PHP related packages and enabled the Apache PHP module, you should restart the Apache2 Web server to run PHP scripts, by running the following command:

```
sudo systemctl restart apache2.service
```

## Testing

To verify your installation, you can run the following PHP `phpinfo` script:

```
<?php
 phpinfo();
?>
```

You can save the content in a file `phpinfo.php` and place it under the `DocumentRoot` directory of the Apache2 Web server. Pointing your browser to `http://hostname/phpinfo.php` will display the values of various PHP configuration parameters.

## References

- For more in depth information see the [php.net](http://php.net) documentation.
- There are a plethora of books on PHP 7 and 8. A good book from O'Reilly is [Learning PHP](#), which includes an exploration of PHP 7's enhancements to the language.
- Also, see the [Apache MySQL PHP Ubuntu Wiki](#) page for more information.

Ruby on Rails is an open source web framework for developing database backed web applications. It is optimized for sustainable productivity of the programmer since it lets the programmer to write code by favouring convention over configuration.

## Installation

Before installing Rails you should install Apache (or a preferred web server) and a database service such as MySQL. To install the Apache package, please refer to [MySQL documentation](#) for example.

Once you have a web server (e.g. Apache) and a database service (e.g. MySQL) installed and configured, you are ready to install Ruby on Rails package.

To install the Ruby base packages and Ruby on Rails, you can enter the following command in the terminal prompt:

```
sudo apt install rails
```

## Configuration

### Web Server

Modify the `/etc/apache2/sites-available/000-default.conf` configuration file to setup your domains.

The first thing to change is the `DocumentRoot` directive:

```
DocumentRoot /path/to/rails/application/public
```

Next, change the `<Directory "/path/to/rails/application/public">` directive:

```
<Directory "/path/to/rails/application/public">
 Options Indexes FollowSymLinks MultiViews ExecCGI
 AllowOverride All
 Order allow,deny
 allow from all
 AddHandler cgi-script .cgi
</Directory>
```

You should also enable the `mod_rewrite` module for Apache. To enable `mod_rewrite` module, please enter the following command in a terminal prompt:

```
sudo a2enmod rewrite
```

Finally you will need to change the ownership of the `/path/to/rails/application/public` and `/path/to/rails/application/tmp` directories to the user used to run the Apache process:

```
sudo chown -R www-data:www-data /path/to/rails/application/public
sudo chown -R www-data:www-data /path/to/rails/application/tmp
```

If you need to compile your application assets run the following command in your application directory:

```
RAILS_ENV=production rake assets:precompile
```

## Database

With your database service in place you need to make sure your app database configuration is also correct. For example, if you are using MySQL your `config/database.yml` should look like this:

```
Mysql
production:
 adapter: mysql2
 username: user
 password: password
 host: 127.0.0.1
 database: app
```

To finally create your application database and apply its migrations you can run the following commands from your app directory:

```
RAILS_ENV=production rake db:create
RAILS_ENV=production rake db:migrate
```

That's it! Now you have your Server ready for your Ruby on Rails application. You can daemonize your application as you want.

## References

- See the [Ruby on Rails](#) website for more information.
- Also [Agile Development with Rails](#) is a great resource.

The primary mechanism for Ubuntu printing and print services is the **Common UNIX Printing System (CUPS)**. This printing system is a freely available, portable printing layer which has become the new standard for printing in most Linux distributions.

CUPS manages print jobs and queues and provides network printing using the standard Internet Printing Protocol (IPP), while offering support for a very large range of printers, from dot-matrix to laser and many in between. CUPS also supports PostScript Printer Description (PPD) and auto-detection of network printers, and features a simple web-based configuration and administration tool.

## Installation

To install CUPS on your Ubuntu computer, simply use `sudo` with the `apt` command and give the packages to install as the first parameter. A complete CUPS install has many package dependencies, but they may all be specified on the same command line. Enter the following at a terminal prompt to install CUPS:

```
sudo apt install cups
```

Upon authenticating with your user password, the packages should be downloaded and installed without error. Upon the conclusion of installation, the CUPS server will be started automatically.

For troubleshooting purposes, you can access CUPS server errors via the error log file at: `/var/log/cups/error_log`. If the error log does not show enough information to troubleshoot any problems you encounter, the verbosity of the CUPS log can be increased by changing the **LogLevel** directive in the configuration file (discussed below) to “debug” or even “debug2”, which logs everything, from the default of “info”. If you make this change, remember to change it back once you’ve solved your problem, to prevent the log file from becoming overly large.

## Configuration

The Common UNIX Printing System server’s behavior is configured through the directives contained in the file `/etc/cups/cupsd.conf`. The CUPS configuration file follows the same syntax as the primary configuration file for the Apache HTTP server, so users familiar with editing Apache’s configuration file should feel at ease when editing the CUPS configuration file. Some examples of settings you may wish to change initially will be presented here.

### Tip

Prior to editing the configuration file, you should make a copy of the original file and protect it from writing, so you will have the original settings as a reference, and to reuse as necessary.

Copy the `/etc/cups/cupsd.conf` file and protect it from writing with the following commands, issued at a terminal prompt:

```
sudo cp /etc/cups/cupsd.conf /etc/cups/cupsd.conf.original
sudo chmod a-w /etc/cups/cupsd.conf.original
```

- **ServerAdmin:** To configure the email address of the designated administrator of the CUPS server, simply edit the `/etc/cups/cupsd.conf` configuration file with your preferred text editor, and add or modify the `ServerAdmin` line accordingly. For example, if you are the Administrator for the CUPS server, and your e-mail address is ‘`bjoy@somebigco.com`’, then you would modify the `ServerAdmin` line to appear as such:

```
ServerAdmin bjoy@somebigco.com
```

- **Listen:** By default on Ubuntu, the CUPS server installation listens only on the loopback interface at IP address `127.0.0.1`. In order to instruct the CUPS server to listen on an actual network adapter’s IP address, you must specify either a hostname, the IP address, or optionally, an IP address/port pairing via the addition of a `Listen` directive. For example, if your CUPS server resides on a local network at the IP address `192.168.10.250` and you’d like to make it accessible to the other systems on this subnet, you would edit the `/etc/cups/cupsd.conf` and add a `Listen` directive, as such:

```
Listen 127.0.0.1:631 # existing loopback Listen
Listen /var/run/cups/cups.sock # existing socket Listen
Listen 192.168.10.250:631 # Listen on the LAN interface, Port 631 (IPP)
```

In the example above, you may comment out or remove the reference to the Loopback address (`127.0.0.1`) if you do not wish `cupsd` to listen on that interface, but would rather have it only listen on the Ethernet interfaces of the Local Area Network (LAN). To enable listening for all network interfaces for which a certain hostname is bound, including the Loopback, you could create a `Listen` entry for the hostname `socrates` as such:

```
Listen socrates:631 # Listen on all interfaces for the hostname 'socrates'
```

or by omitting the `Listen` directive and using `Port` instead, as in:

```
Port 631 # Listen on port 631 on all interfaces
```

For more examples of configuration directives in the CUPS server configuration file, view the associated system manual page by entering the following command at a terminal prompt:

```
man cupsd.conf
```

### Note

Whenever you make changes to the `/etc/cups/cupsd.conf` configuration file, you’ll need to restart the CUPS server by typing the following command at a terminal prompt:

```
sudo systemctl restart cups.service
```

## Web Interface

### Tip

CUPS can be configured and monitored using a web interface, which by default is available at `http://localhost:631/admin`. The web interface can be used to perform all printer management tasks.

In order to perform administrative tasks via the web interface, you must either have the root account enabled on your server, or authenticate as a user in the *lpadmin* group. For security reasons, CUPS won't authenticate a user that doesn't have a password.

To add a user to the *lpadmin* group, run at the terminal prompt:

```
sudo usermod -aG lpadmin username
```

Further documentation is available in the *Documentation/Help* tab of the web interface.

## References

[CUPS Website](#)

[Debian Open-iSCSI page](#)

This section describes what `debuginfod` is and how users can benefit from Ubuntu's `debuginfod` service.

## What is debuginfod?

From the [project's official page](#):

debuginfod is a client/server [...] that automatically distributes ELF/DWARF/source-code from servers to clients such as debuggers across HTTP.

This means that users will be able to debug programs shipped with Ubuntu without the need to [manually install](#) the distribution's debuginfo packages.

Ubuntu maintains its own `debuginfod` service, which regularly indexes the debug symbols present in `ddebs` and other packages and serve this information over HTTPS.

Currently, the service only provides DWARF information. There are plans to make it also index and serve source-code in the future.

## Using the service

From Kinetic onwards, when you install GDB your system will be automatically configured to use Ubuntu's `debuginfod` service. For previous Ubuntu releases, you can manually enable the service by setting the `DEBUGINFOD_URLS` environment variable in your shell. If you use Bash, you can do that by adding the following snippet to your `~/.bashrc`:

```
export DEBUGINFOD_URLS="https://debuginfod.ubuntu.com"
```

When you run GDB, and if you have the `DEBUGINFOD_URLS` variable in your environment, you will be asked whether you would like to use the service. If you want to make sure that GDB always uses `debuginfod`, you can put the following snippet inside your `~/.gdbinit` file:

```
set debuginfod enabled on
```

The debug symbol files will be downloaded on-the-fly during the debugging session, and will be saved locally inside the `~/.cache/debuginfod_client/` directory. You can safely remove this directory or any files inside it; they will be downloaded again only if and when needed.

## Example session with GDB

Assuming that you have enabled the use of `debuginfod` in your system, here is what happens when you invoke GDB to debug a binary from an Ubuntu package:

```
$ gdb -q program
Reading symbols from program...
```

This GDB supports auto-downloading debuginfo from the following URLs:

```
https://debuginfod.ubuntu.com
```

```
Enable debuginfod for this session? (y or [n])
```

When you answer `y` to the question above, GDB will download the debug symbols for `program`:

```
Enable debuginfod for this session? (y or [n]) y
```

```
Debuginfod has been enabled.
```

```
To make this setting permanent, add 'set debuginfod enabled on' to .gdbinit.
```

```
Downloading 0.20 MB separate debug info for /home/ubuntu/program
```

```
Reading symbols from /home/ubuntu/.cache/debuginfod_client/c0fbda15a807f880e9d0b2dcc635eeeb1f0f728e/debuginfo...
```

```
(gdb)
```

## Opting out of the service

If, for some reason, you prefer not to use the service, you can opt-out of it by unsetting the `DEBUGINFOD_URLS` environment variable. This can be done by putting the following snippet inside your shell's configuration file:

```
unset DEBUGINFOD_URLS
```

You can also disable GDB's willingness to use `debuginfod` by putting the following snippet inside your `~/.gdbinit`:

```
set debuginfod enabled off
```

## FAQ

If you have more questions about the service, please refer to the [FAQ page](#).

## What releases of Ubuntu are supported by the service?

`debuginfod` is currently indexing `ddebs` packages from all [supported Ubuntu releases](#). Once a release goes unsupported, we stop indexing `ddebs` from it and eventually stop serving debug symbols for its packages.

## How does debuginfod know how to find the debug symbols for the binary I am debugging?

`debuginfod` relies on a unique hash that identifies binaries and shared libraries called **Build-ID**. This 160-bit SHA-1 hash is generated by the compiler, and can be consulted using tools like `readelf`:

```
$ readelf -n /usr/bin/bash
```

```
Displaying notes found in: .note.gnu.property
```

Owner	Data size	Description
GNU	0x00000020	NT_GNU_PROPERTY_TYPE_0
Properties: x86 feature: IBT, SHSTK		
x86 ISA needed: x86-64-baseline		

```
Displaying notes found in: .note.gnu.build-id
```

Owner	Data size	Description
GNU	0x00000014	NT_GNU_BUILD_ID (unique build ID bitstring)
Build ID: 3e770d2cd0302c6ff2a184e8d2bf4ec98cfcdded4		

```
Displaying notes found in: .note.ABI-tag
```

Owner	Data size	Description
GNU	0x00000010	NT_GNU_ABI_TAG (ABI version tag)
OS: Linux, ABI: 3.2.0		

When you are debugging a program, GDB will send the program's Build-ID to the `debuginfod` server, who will check if it has the corresponding debug information for that binary/library. If it does, then it will send the debug symbols over HTTPS back to GDB.

## Where does debuginfod store the debug information it downloads?

The debug symbols downloaded from the service are saved inside `$XDG_CACHE_HOME/.debuginfod_client/`. If `$XDG_CACHE_HOME` is empty, then `~/.cache/` is used instead.

## Can I remove files from the cache directory?

Yes, you can. `debuginfod` will simply download them again if and when needed.

## Can ddebs packages co-exist with debuginfod?

Yes. GDB will try to use local debug information if available. That means that if you have a `ddeb` package installed that provides the necessary debug symbols for the program being debugged (or if you have already downloaded that information from the `debuginfod` service earlier), then GDB will use it in favour of performing the download.

## Can I use debuginfod with my own binary that links against system libraries?

Yes! `debuginfod` will obviously not be able to provide any debug symbols for your own program, but it will happily serve debug information for any system libraries that your program links against.

Domain Name Service (DNS) is an Internet service that maps IP addresses and fully qualified domain names (FQDN) to one another. In this way, DNS alleviates the need to remember IP addresses. Computers that run DNS are called *name servers*. Ubuntu ships with BIND (Berkley Internet Naming Daemon), the most common program used for maintaining a name server on Linux.

## Installation

At a terminal prompt, enter the following command to install dns:

```
sudo apt install bind9
```

A very useful package for testing and troubleshooting DNS issues is the `dnsutils` package. Very often these tools will be installed already, but to check and/or install `dnsutils` enter the following:

```
sudo apt install dnsutils
```

## Configuration

There are many ways to configure BIND9. Some of the most common configurations are a caching nameserver, primary server, and secondary server.

- When configured as a caching nameserver BIND9 will find the answer to name queries and remember the answer when the domain is queried again.
- As a primary server, BIND9 reads the data for a zone from a file on its host and is authoritative for that zone.
- As a secondary server, BIND9 gets the zone data from another nameserver that is authoritative for the zone.

## Overview

The DNS configuration files are stored in the `/etc/bind` directory. The primary configuration file is `/etc/bind/named.conf`, which in the layout provided by the package just includes these files.

- `/etc/bind/named.conf.options`: global DNS options
- `/etc/bind/named.conf.local`: for your zones
- `/etc/bind/named.conf.default-zones`: default zones such as localhost, its reverse, and the root hints

The root nameservers used to be described in the file `/etc/bind/db.root`. This is now provided instead by the `/usr/share/dns/root.hints` file shipped with the `dns-root-data` package, and is referenced in the `named.conf.default-zones` configuration file above.

It is possible to configure the same server to be a caching name server, primary, and secondary: it all depends on the zones it is serving. A server can be the Start of Authority (SOA) for one zone, while providing secondary service for another zone. All the while providing caching services for hosts on the local LAN.

## Caching Nameserver

The default configuration acts as a caching server. Simply uncomment and edit `/etc/bind/named.conf.options` to set the IP addresses of your ISP's DNS servers:

```
forwarders {
 1.2.3.4;
 5.6.7.8;
};
```

### Note

Replace `1.2.3.4` and `5.6.7.8` with the IP Addresses of actual nameservers.

To enable the new configuration, restart the DNS server. From a terminal prompt:

```
sudo systemctl restart bind9.service
```

See [dig](#) for information on testing a caching DNS server.

## Primary Server

In this section BIND9 will be configured as the Primary server for the domain `example.com`. Simply replace `example.com` with your FQDN (Fully Qualified Domain Name).

## Forward Zone File

To add a DNS zone to BIND9, turning BIND9 into a Primary server, first edit `/etc/bind/named.conf.local`:

```
zone "example.com" {
 type master;
 file "/etc/bind/db.example.com";
};
```

### Note

If bind will be receiving automatic updates to the file as with DDNS, then use `/var/lib/bind/db.example.com` rather than `/etc/bind/db.example.com` both here and in the copy command below.

Now use an existing zone file as a template to create the `/etc/bind/db.example.com` file:

```
sudo cp /etc/bind/db.local /etc/bind/db.example.com
```

Edit the new zone file `/etc/bind/db.example.com` and change `localhost.` to the FQDN of your server, leaving the additional `.` at the end. Change `127.0.0.1` to the nameserver's IP Address and `root.localhost` to a valid email address, but with a `.` instead of the usual `@` symbol, again leaving the `.` at the end. Change the comment to indicate the domain that this file is for.

Create an *A record* for the base domain, `example.com`. Also, create an *A record* for `ns.example.com`, the name server in this example:

```
;
; BIND data file for example.com
;
$TTL 604800
@ IN SOA example.com. root.example.com. (
 2 ; Serial
 604800 ; Refresh
 86400 ; Retry
 2419200 ; Expire
 604800) ; Negative Cache TTL

@ IN NS ns.example.com.
@ IN A 192.168.1.10
@ IN AAAA ::1
ns IN A 192.168.1.10
```

You must increment the *Serial Number* every time you make changes to the zone file. If you make multiple changes before restarting BIND9, simply increment the Serial once.

Now, you can add DNS records to the bottom of the zone file. See [Common Record Types](#) for details.

### Note

Many admins like to use the last date edited as the serial of a zone, such as `2020012100` which is *yyyymmddss* (where *ss* is the Serial Number)

Once you have made changes to the zone file BIND9 needs to be restarted for the changes to take effect:

```
sudo systemctl restart bind9.service
```

## Reverse Zone File

Now that the zone is setup and resolving names to IP Addresses, a *Reverse zone* needs to be added to allows DNS to resolve an address to a name.

Edit `/etc/bind/named.conf.local` and add the following:

```
zone "1.168.192.in-addr.arpa" {
 type master;
 file "/etc/bind/db.192";
};
```

### Note

Replace `1.168.192` with the first three octets of whatever network you are using. Also, name the zone file `/etc/bind/db.192` appropriately. It should match the first octet of your network.



Now create the `/etc/bind/db.192` file:

```
sudo cp /etc/bind/db.127 /etc/bind/db.192
```

Next edit `/etc/bind/db.192` changing the same options as `/etc/bind/db.example.com`:

```
;
; BIND reverse data file for local 192.168.1.XXX net
;
$TTL 604800
@ IN SOA ns.example.com. root.example.com. (
 2 ; Serial
 604800 ; Refresh
 86400 ; Retry
 2419200 ; Expire
 604800) ; Negative Cache TTL
;
@ IN NS ns.
10 IN PTR ns.example.com.
```

The *Serial Number* in the Reverse zone needs to be incremented on each change as well. For each *A record* you configure in `/etc/bind/db.example.com`, that is for a different address, you need to create a *PTR record* in `/etc/bind/db.192`.

After creating the reverse zone file restart BIND9:

```
sudo systemctl restart bind9.service
```

## Secondary Server

Once a *Primary Server* has been configured a *Secondary Server* is highly recommended in order to maintain the availability of the domain should the Primary become unavailable.

First, on the Primary server, the zone transfer needs to be allowed. Add the `allow-transfer` option to the example Forward and Reverse zone definitions in `/etc/bind/named.conf.local`:

```
zone "example.com" {
 type master;
 file "/etc/bind/db.example.com";
 allow-transfer { 192.168.1.11; };
};

zone "1.168.192.in-addr.arpa" {
 type master;
 file "/etc/bind/db.192";
 allow-transfer { 192.168.1.11; };
};
```

### Note

Replace `192.168.1.11` with the IP Address of your Secondary nameserver.

Restart BIND9 on the Primary server:

```
sudo systemctl restart bind9.service
```

Next, on the Secondary server, install the `bind9` package the same way as on the Primary. Then edit the `/etc/bind/named.conf.local` and add the following declarations for the Forward and Reverse zones:

```
zone "example.com" {
 type secondary;
 file "db.example.com";
 masters { 192.168.1.10; };
};

zone "1.168.192.in-addr.arpa" {
 type secondary;
 file "db.192";
 masters { 192.168.1.10; };
};
```

## Note

Replace 192.168.1.10 with the IP Address of your Primary nameserver.

Restart BIND9 on the Secondary server:

```
sudo systemctl restart bind9.service
```

In /var/log/syslog you should see something similar to the following (some lines have been split to fit the format of this document):

```
client 192.168.1.10#39448: received notify for zone '1.168.192.in-addr.arpa'
zone 1.168.192.in-addr.arpa/IN: Transfer started.
transfer of '100.18.172.in-addr.arpa/IN' from 192.168.1.10#53:
 connected using 192.168.1.11#37531
zone 1.168.192.in-addr.arpa/IN: transferred serial 5
transfer of '100.18.172.in-addr.arpa/IN' from 192.168.1.10#53:
 Transfer completed: 1 messages,
6 records, 212 bytes, 0.002 secs (106000 bytes/sec)
zone 1.168.192.in-addr.arpa/IN: sending notifies (serial 5)

client 192.168.1.10#20329: received notify for zone 'example.com'
zone example.com/IN: Transfer started.
transfer of 'example.com/IN' from 192.168.1.10#53: connected using 192.168.1.11#38577
zone example.com/IN: transferred serial 5
transfer of 'example.com/IN' from 192.168.1.10#53: Transfer completed: 1 messages,
8 records, 225 bytes, 0.002 secs (112500 bytes/sec)
```

## Note

Note: A zone is only transferred if the *Serial Number* on the Primary is larger than the one on the Secondary. If you want to have your Primary DNS notifying other Secondary DNS Servers of zone changes, you can add `also-notify { ipaddress; };` to `/etc/bind/named.conf.local` as shown in the example below:

```
zone "example.com" {
 type master;
 file "/etc/bind/db.example.com";
 allow-transfer { 192.168.1.11; };
 also-notify { 192.168.1.11; };
};

zone "1.168.192.in-addr.arpa" {
 type master;
 file "/etc/bind/db.192";
 allow-transfer { 192.168.1.11; };
 also-notify { 192.168.1.11; };
};
```

## Note

The default directory for non-authoritative zone files is `/var/cache/bind/`. This directory is also configured in AppArmor to allow the named daemon to write to it. For more information on AppArmor see [Security - AppArmor](#).

## Troubleshooting

This section covers diagnosing problems with DNS and BIND9 configurations.

## Testing

### resolv.conf

The first step in testing BIND9 is to add the nameserver's IP Address to a hosts resolver. The Primary nameserver should be configured as well as another host to double check things. Refer to [DNS client configuration](#) for details on adding nameserver addresses to your network clients. In the end your `nameserver` line in `/etc/resolv.conf` should be pointing at 127.0.0.53 and you should have a `search` parameter for your domain. Something like this:

```
nameserver 127.0.0.53
```

```
search example.com
```

To check which DNS server your local resolver is using, run:

```
systemd-resolve --status
```

### Note

You should also add the IP Address of the Secondary nameserver to your client configuration in case the Primary becomes unavailable.

## dig

If you installed the `dnsutils` package you can test your setup using the DNS lookup utility `dig`:

- After installing BIND9 use `dig` against the loopback interface to make sure it is listening on port 53. From a terminal prompt:

```
dig -x 127.0.0.1
```

You should see lines similar to the following in the command output:

```
;; Query time: 1 msec
;; SERVER: 192.168.1.10#53(192.168.1.10)
```

- If you have configured BIND9 as a *Caching* nameserver “`dig`” an outside domain to check the query time:

```
dig ubuntu.com
```

Note the query time toward the end of the command output:

```
;; Query time: 49 msec
```

After a second `dig` there should be improvement:

```
;; Query time: 1 msec
```

## ping

Now to demonstrate how applications make use of DNS to resolve a host name use the `ping` utility to send an ICMP echo request:

```
ping example.com
```

This tests if the nameserver can resolve the name `ns.example.com` to an IP Address. The command output should resemble:

```
PING ns.example.com (192.168.1.10) 56(84) bytes of data.
64 bytes from 192.168.1.10: icmp_seq=1 ttl=64 time=0.800 ms
64 bytes from 192.168.1.10: icmp_seq=2 ttl=64 time=0.813 ms
```

## named-checkzone

A great way to test your zone files is by using the `named-checkzone` utility installed with the `bind9` package. This utility allows you to make sure the configuration is correct before restarting BIND9 and making the changes live.

- To test our example Forward zone file enter the following from a command prompt:

```
named-checkzone example.com /etc/bind/db.example.com
```

If everything is configured correctly you should see output similar to:

```
zone example.com/IN: loaded serial 6
OK
```

- Similarly, to test the Reverse zone file enter the following:

```
named-checkzone 1.168.192.in-addr.arpa /etc/bind/db.192
```

The output should be similar to:

```
zone 1.168.192.in-addr.arpa/IN: loaded serial 3
OK
```

### Note

The *Serial Number* of your zone file will probably be different.

## Quick temporary query logging

With the `rndc` tool, you can quickly turn query logging on and off, without restarting the service or changing the configuration file.

To turn query logging *on*, run:

```
sudo rndc querylog on
```

Likewise, to turn it off, run:

```
sudo rndc querylog off
```

The logs will be sent to syslog and will show up in `/var/log/syslog` by default:

```
Jan 20 19:40:50 new-n1 named[816]: received control channel command 'querylog on'
```

```
Jan 20 19:40:50 new-n1 named[816]: query logging is now on
```

```
Jan 20 19:40:57 new-n1 named[816]: client @0x7f48ec101480 192.168.1.10#36139 (ubuntu.com): query: ubuntu.com IN A +E(0)K (
```

### Note

The amount of logs generated by enabling `querylog` could be huge!

## Logging

BIND9 has a wide variety of logging configuration options available, but the two main ones are *channel* and *category*, which configure where logs go, and what information gets logged, respectively.

If no logging options are configured the default configuration is:

```
logging {
 category default { default_syslog; default_debug; };
 category unmatched { null; };
};
```

Let's instead configure BIND9 to send *debug* messages related to DNS queries to a separate file.

We need to configure a *channel* to specify which file to send the messages to, and a *category*. In this example, the *category* will log all queries. Edit `/etc/bind/named.conf.local` and add the following:

```
logging {
 channel query.log {
 file "/var/log/named/query.log";
 severity debug 3;
 };
 category queries { query.log; };
};
```

### Note

The *debug* option can be set from 1 to 3. If a level isn't specified, level 1 is the default.

- Since the *named daemon* runs as the *bind* user the `/var/log/named` directory must be created and the ownership changed:

```
sudo mkdir /var/log/named
sudo chown bind:bind /var/log/named
```

- Now restart BIND9 for the changes to take effect:

```
sudo systemctl restart bind9.service
```

You should see the file `/var/log/named/query.log` fill with query information. This is a simple example of the BIND9 logging options. For coverage of advanced options see [More Information](#).

## References

### Common Record Types

This section covers some of the most common DNS record types.

- A record: This record maps an IP Address to a hostname.

```
www IN A 192.168.1.12
```

- **CNAME record:** Used to create an alias to an existing A record. You cannot create a CNAME record pointing to another CNAME record.

```
web IN CNAME www
```

- **MX record:** Used to define where email should be sent to. Must point to an A record, not a CNAME.

```
@ IN MX 1 mail.example.com.
mail IN A 192.168.1.13
```

- **NS record:** Used to define which servers serve copies of a zone. It must point to an A record, not a CNAME. This is where Primary and Secondary servers are defined.

```
@ IN NS ns.example.com.
@ IN NS ns2.example.com.
ns IN A 192.168.1.10
ns2 IN A 192.168.1.11
```

## More Information

- [Upstream BIND9 Documentation](#)
- [DNS and BIND](#) is a popular book now in its fifth edition. There is now also a [DNS and BIND on IPv6](#) book.
- A great place to ask for BIND9 assistance, and get involved with the Ubuntu Server community, is the [#ubuntu-server](#) IRC channel on [Libera Chat](#).

File Transfer Protocol (FTP) is a TCP protocol for downloading files between computers. In the past, it has also been used for uploading but, as that method does not use encryption, user credentials as well as data transferred in the clear and are easily intercepted. So if you are here looking for a way to upload and download files securely, see the [OpenSSH documentation](#) instead.

FTP works on a client/server model. The server component is called an *FTP daemon*. It continuously listens for FTP requests from remote clients. When a request is received, it manages the login and sets up the connection. For the duration of the session it executes any of commands sent by the FTP client.

Access to an FTP server can be managed in two ways:

- Anonymous
- Authenticated

In the Anonymous mode, remote clients can access the FTP server by using the default user account called “anonymous” or “ftp” and sending an email address as the password. In the Authenticated mode a user must have an account and a password. This latter choice is very insecure and should not be used except in special circumstances. If you are looking to transfer files securely see SFTP in the section on OpenSSH-Server. User access to the FTP server directories and files is dependent on the permissions defined for the account used at login. As a general rule, the FTP daemon will hide the root directory of the FTP server and change it to the FTP Home directory. This hides the rest of the file system from remote sessions.

## vsftpd - FTP Server Installation

vsftpd is an FTP daemon available in Ubuntu. It is easy to install, set up, and maintain. To install vsftpd you can run the following command:

```
sudo apt install vsftpd
```

## Anonymous FTP Configuration

By default vsftpd is *not* configured to allow anonymous download. If you wish to enable anonymous download edit `/etc/vsftpd.conf` by changing:

```
anonymous_enable=YES
```

During installation a *ftp* user is created with a home directory of `/srv/ftp`. This is the default FTP directory.

If you wish to change this location, to `/srv/files/ftp` for example, simply create a directory in another location and change the *ftp* user’s home directory:

```
sudo mkdir -p /srv/files/ftp
sudo usermod -d /srv/files/ftp ftp
```

After making the change restart vsftpd:

```
sudo systemctl restart vsftpd.service
```

Finally, copy any files and directories you would like to make available through anonymous FTP to `/srv/files/ftp`, or `/srv/ftp` if you wish to use the default.

## User Authenticated FTP Configuration

By default vsftpd is configured to authenticate system users and allow them to download files. If you want users to be able to upload files, edit `/etc/vsftpd.conf`:

```
write_enable=YES
```

Now restart vsftpd:

```
sudo systemctl restart vsftpd.service
```

Now when system users login to FTP they will start in their *home* directories where they can download, upload, create directories, etc.

Similarly, by default, anonymous users are not allowed to upload files to FTP server. To change this setting, you should uncomment the following line, and restart vsftpd:

```
anon_upload_enable=YES
```

### Warning

Enabling anonymous FTP upload can be an extreme security risk. It is best to not enable anonymous upload on servers accessed directly from the Internet.

The configuration file consists of many configuration parameters. The information about each parameter is available in the configuration file. Alternatively, you can refer to the man page, `man 5 vsftpd.conf` for details of each parameter.

## Securing FTP

There are options in `/etc/vsftpd.conf` to help make vsftpd more secure. For example users can be limited to their home directories by uncommenting:

```
chroot_local_user=YES
```

You can also limit a specific list of users to just their home directories:

```
chroot_list_enable=YES
chroot_list_file=/etc/vsftpd.chroot_list
```

After uncommenting the above options, create a `/etc/vsftpd.chroot_list` containing a list of users one per line. Then restart vsftpd:

```
sudo systemctl restart vsftpd.service
```

Also, the `/etc/ftpusers` file is a list of users that are *disallowed* FTP access. The default list includes root, daemon, nobody, etc. To disable FTP access for additional users simply add them to the list.

FTP can also be encrypted using *FTPS*. Different from *SFTP*, *FTPS* is FTP over Secure Socket Layer (SSL). *SFTP* is a FTP like session over an encrypted *SSH* connection. A major difference is that users of SFTP need to have a *shell* account on the system, instead of a *nologin* shell. Providing all users with a shell may not be ideal for some environments, such as a shared web host. However, it is possible to restrict such accounts to only SFTP and disable shell interaction.

To configure *FTPS*, edit `/etc/vsftpd.conf` and at the bottom add:

```
ssl_enable=YES
```

Also, notice the certificate and key related options:

```
rsa_cert_file=/etc/ssl/certs/ssl-cert-snakeoil.pem
rsa_private_key_file=/etc/ssl/private/ssl-cert-snakeoil.key
```

By default these options are set to the certificate and key provided by the `ssl-cert` package. In a production environment these should be replaced with a certificate and key generated for the specific host. For more information on certificates see [Security - Certificates](#).

Now restart vsftpd, and non-anonymous users will be forced to use *FTPS*:

```
sudo systemctl restart vsftpd.service
```

To allow users with a shell of `/usr/sbin/nologin` access to FTP, but have no shell access, edit `/etc/shells` adding the `nologin` shell:

```
/etc/shells: valid login shells
/bin/csh
/bin/sh
/usr/bin/es
/usr/bin/ksh
/bin/ksh
/usr/bin/rc
/usr/bin/tcsh
/bin/tcsh
/usr/bin/esh
/bin/dash
/bin/bash
/bin/rbash
/usr/bin/screen
/usr/sbin/nologin
```

This is necessary because, by default vsftpd uses PAM for authentication, and the `/etc/pam.d/vsftpd` configuration file contains:

```
auth required pam_shells.so
```

The `shells` PAM module restricts access to shells listed in the `/etc/shells` file.

Most popular FTP clients can be configured to connect using FTPS. The `lftp` command line FTP client has the ability to use FTPS as well.

## References

- See the [vsftpd website](#) for more information.

Wikipedia [iSCSI Definition](#):

iSCSI an acronym for **I**nternet **S**mall **C**omputer **S**ystems **I**nterface , an **I**nternet **P**rotocol (IP)-based storage networking standard for linking data storage facilities. It provides [block-level access to storage devices](#) by carrying [SCSI](#) commands over a [TCP/IP](#) network.

iSCSI is used to facilitate data transfers over [intranets](#) and to manage storage over long distances. It can be used to transmit data over [local area networks](#) (LANs), [wide area networks](#) (WANs), or the [Internet](#) and can enable location-independent data storage and retrieval.

The [protocol](#) allows clients (called *initiators*) to send SCSI commands (*CDBs*) to storage devices (*targets*) on remote servers. It is a [storage area network](#) (SAN) protocol, allowing organizations to consolidate storage into [storage arrays](#) while providing clients (such as database and web servers) with the illusion of locally attached SCSI disks.

It mainly competes with [Fibre Channel](#), but unlike traditional Fibre Channel, which usually requires dedicated cabling, iSCSI can be run over long distances using existing network infrastructure.

Ubuntu Server can be configured as both: **iSCSI initiator** and **iSCSI target**. This guide provides commands and configuration options to setup an **iSCSI initiator** (or Client).

*Note: It is assumed that **you already have an iSCSI target on your local network** and have the appropriate rights to connect to it. The instructions for setting up a target vary greatly between hardware providers, so consult your vendor documentation to configure your specific iSCSI target.*

## Network Interfaces Configuration

Before start configuring iSCSI, make sure to have the network interfaces correctly set and configured in order to have open-iscsi package to behave appropriately, specially during boot time. In Ubuntu 20.04 LTS, the default network configuration tool is [netplan.io](#).

For all the iSCSI examples bellow please consider the following netplan configuration for my iSCSI initiator:

```
/etc/cloud/cloud.cfg.d/99-disable-network-config.cfg
{config: disabled}
/etc/netplan/50-cloud-init.yaml
```

```

network:
 ethernets:
 enp5s0:
 match:
 macaddress: 00:16:3e:af:c4:d6
 set-name: eth0
 dhcp4: true
 dhcp-identifier: mac
 enp6s0:
 match:
 macaddress: 00:16:3e:50:11:9c
 set-name: iscsi01
 dhcp4: true
 dhcp-identifier: mac
 dhcp4-overrides:
 route-metric: 300
 enp7s0:
 match:
 macaddress: 00:16:3e:b3:cc:50
 set-name: iscsi02
 dhcp4: true
 dhcp-identifier: mac
 dhcp4-overrides:
 route-metric: 300
 version: 2
 renderer: networkd

```

With this configuration, the interfaces names change by matching their mac addresses. This makes it easier to manage them in a server containing multiple interfaces.

From this point and beyond, 2 interfaces are going to be mentioned: **iscsi01** and **iscsi02**. This helps to demonstrate how to configure iSCSI in a multipath environment as well (check the Device Mapper Multipath session in this same Server Guide).

If you have only a single interface for the iSCSI network, make sure to follow the same instructions, but only consider the **iscsi01** interface command line examples.

## iSCSI Initiator Install

To configure Ubuntu Server as an iSCSI initiator install the open-iscsi package. In a terminal enter:

```
$ sudo apt install open-iscsi
```

Once the package is installed you will find the following files:

- /etc/iscsi/iscsid.conf
- /etc/iscsi/initiatorname.iscsi

## iSCSI Initiator Configuration

Configure the main configuration file like the example bellow:

```

/etc/iscsi/iscsid.conf

startup settings

will be controlled by systemd, leave as is
iscsid.startup = /usr/sbin/iscsidnode.startup = manual

chap settings

node.session.auth.authmethod = CHAP

authentication of initiator by target (session)
node.session.auth.username = username
node.session.auth.password = password

```



```

discovery.sendtargets.auth.authmethod = CHAP

authentication of initiator by target (discovery)
discovery.sendtargets.auth.username = username
discovery.sendtargets.auth.password = password

timeouts

control how much time iscsi takes to propagate an error to the
upper layer. if using multipath, having 0 here is desirable
so multipath can handle path errors as quickly as possible
(and decide to queue or not if missing all paths)
node.session.timeo.replacement_timeout = 0

node.conn[0].timeo.login_timeout = 15
node.conn[0].timeo.logout_timeout = 15

interval for a NOP-Out request (a ping to the target)
node.conn[0].timeo.noop_out_interval = 5

and how much time to wait before declaring a timeout
node.conn[0].timeo.noop_out_timeout = 5

default timeouts for error recovery logics (lu & tgt resets)
node.session.err_timeo.abort_timeout = 15
node.session.err_timeo.lu_reset_timeout = 30
node.session.err_timeo.tgt_reset_timeout = 30

retry

node.session.initial_login_retry_max = 8

session and device queue depth

node.session.cmds_max = 128
node.session.queue_depth = 32

performance

node.session.xmit_thread_priority = -20

```

and re-start the iSCSI daemon:

```
$ systemctl restart iscsid.service
```

This will set basic things up for the rest of configuration.

The other file mentioned:

```

/etc/iscsi/initiatorname.iscsi

InitiatorName=iqn.2004-10.com.ubuntu:01:60f3517884c3

```

contains this node's initiator name and is generated during open-iscsi package installation. If you modify this setting, make sure that you don't have duplicates in the same iSCSI SAN (Storage Area Network).

## iSCSI Network Configuration

Before configuring the Logical Units that are going to be accessed by the initiator, it is important to inform the iSCSI service what are the interfaces acting as paths.

A straightforward way to do that is by:

- configuring the following environment variables

```

$ iscsi01_ip=$(ip -4 -o addr show iscsi01 | sed -r 's:.* ([[0-9]{1,3}\.){3}[0-9]{1,3}]/.*:1:')
$ iscsi02_ip=$(ip -4 -o addr show iscsi02 | sed -r 's:.* ([[0-9]{1,3}\.){3}[0-9]{1,3}]/.*:1:')

```

```
$ iscsi01_mac=$(ip -o link show iscsi01 | sed -r 's:.*\s+link/ether ([0-f]{2}(\:|))\{6\}.*:\1:g')
$ iscsi02_mac=$(ip -o link show iscsi02 | sed -r 's:.*\s+link/ether ([0-f]{2}(\:|))\{6\}.*:\1:g')
```

- configuring **iscsi01** interface

```
$ sudo iscsiadm -m iface -I iscsi01 --op=new
New interface iscsi01 added
$ sudo iscsiadm -m iface -I iscsi01 --op=update -n iface.hwaddress -v $iscsi01_mac
iscsi01 updated.
$ sudo iscsiadm -m iface -I iscsi01 --op=update -n iface.ipaddress -v $iscsi01_ip
iscsi01 updated.
```

- configuring **iscsi02** interface

```
$ sudo iscsiadm -m iface -I iscsi02 --op=new
New interface iscsi02 added
$ sudo iscsiadm -m iface -I iscsi02 --op=update -n iface.hwaddress -v $iscsi02_mac
iscsi02 updated.
$ sudo iscsiadm -m iface -I iscsi02 --op=update -n iface.ipaddress -v $iscsi02_ip
iscsi02 updated.
```

- discovering the **targets**

```
$ sudo iscsiadm -m discovery -I iscsi01 --op=new --op=del --type sendtargets --portal storage.iscsi01
10.250.94.99:3260,1 iqn.2003-01.org.linux-iscsi.storage.x8664:sn.2c084c8320ca
```

```
$ sudo iscsiadm -m discovery -I iscsi02 --op=new --op=del --type sendtargets --portal storage.iscsi02
10.250.93.99:3260,1 iqn.2003-01.org.linux-iscsi.storage.x8664:sn.2c084c8320ca
```

- configuring **automatic login**

```
$ sudo iscsiadm -m node --op=update -n node.conn[0].startup -v automatic
$ sudo iscsiadm -m node --op=update -n node.startup -v automatic
```

- make sure needed **services** are enabled during OS initialization:

```
$ systemctl enable open-iscsi
Synchronizing state of open-iscsi.service with SysV service script with /lib/systemd/systemd-sysv-install.
Executing: /lib/systemd/systemd-sysv-install enable open-iscsi
Created symlink /etc/systemd/system/iscsi.service → /lib/systemd/system/open-iscsi.service.
Created symlink /etc/systemd/system/sysinit.target.wants/open-iscsi.service → /lib/systemd/system/open-iscsi.service.
```

```
$ systemctl enable iscsid
Synchronizing state of iscsid.service with SysV service script with /lib/systemd/systemd-sysv-install.
Executing: /lib/systemd/systemd-sysv-install enable iscsid
Created symlink /etc/systemd/system/sysinit.target.wants/iscsid.service → /lib/systemd/system/iscsid.service.
```

- restarting **iscsid** service

```
$ systemctl restart iscsid.service
```

- and, finally, **login in** discovered logical units

```
$ sudo iscsiadm -m node --loginall=automatic
Logging in to [iface: iscsi02, target: iqn.2003-01.org.linux-iscsi.storage.x8664:sn.2c084c8320ca, portal: 10.250.93.99,3260]
Logging in to [iface: iscsi01, target: iqn.2003-01.org.linux-iscsi.storage.x8664:sn.2c084c8320ca, portal: 10.250.94.99,3260]
Login to [iface: iscsi02, target: iqn.2003-01.org.linux-iscsi.storage.x8664:sn.2c084c8320ca, portal: 10.250.93.99,3260]
Login to [iface: iscsi01, target: iqn.2003-01.org.linux-iscsi.storage.x8664:sn.2c084c8320ca, portal: 10.250.94.99,3260]
```

## Accessing the Logical Units (or LUNs)

Check dmesg to make sure that the new disks have been detected:

```
dmesg
[166.840694] scsi 7:0:0:4: Direct-Access LI0-ORG TCMU device > 0002 PQ: 0 ANSI: 5
[166.840892] scsi 8:0:0:4: Direct-Access LI0-ORG TCMU device > 0002 PQ: 0 ANSI: 5
[166.841741] sd 7:0:0:4: Attached scsi generic sg2 type 0
[166.841808] sd 8:0:0:4: Attached scsi generic sg3 type 0
[166.842278] scsi 7:0:0:3: Direct-Access LI0-ORG TCMU device > 0002 PQ: 0 ANSI: 5
```

```

[166.842571] scsi 8:0:0:3: Direct-Access LI0-ORG TCMU device > 0002 PQ: 0 ANSI: 5
[166.843482] sd 8:0:0:3: Attached scsi generic sg4 type 0
[166.843681] sd 7:0:0:3: Attached scsi generic sg5 type 0
[166.843706] sd 8:0:0:4: [sdd] 2097152 512-byte logical blocks: > (1.07 GB/1.00 GiB)
[166.843884] scsi 8:0:0:2: Direct-Access LI0-ORG TCMU device > 0002 PQ: 0 ANSI: 5
[166.843971] sd 8:0:0:4: [sdd] Write Protect is off
[166.843972] sd 8:0:0:4: [sdd] Mode Sense: 2f 00 00 00
[166.844127] scsi 7:0:0:2: Direct-Access LI0-ORG TCMU device > 0002 PQ: 0 ANSI: 5
[166.844232] sd 7:0:0:4: [sdc] 2097152 512-byte logical blocks: > (1.07 GB/1.00 GiB)
[166.844421] sd 8:0:0:4: [sdd] Write cache: enabled, read cache: > enabled, doesn't support DPO or FUA
[166.844566] sd 7:0:0:4: [sdc] Write Protect is off
[166.844568] sd 7:0:0:4: [sdc] Mode Sense: 2f 00 00 00
[166.844846] sd 8:0:0:2: Attached scsi generic sg6 type 0
[166.845147] sd 7:0:0:4: [sdc] Write cache: enabled, read cache: > enabled, doesn't support DPO or FUA
[166.845188] sd 8:0:0:4: [sdd] Optimal transfer size 65536 bytes
[166.845527] sd 7:0:0:2: Attached scsi generic sg7 type 0
[166.845678] sd 8:0:0:3: [sde] 2097152 512-byte logical blocks: > (1.07 GB/1.00 GiB)
[166.845785] scsi 8:0:0:1: Direct-Access LI0-ORG TCMU device > 0002 PQ: 0 ANSI: 5
[166.845799] sd 7:0:0:4: [sdc] Optimal transfer size 65536 bytes
[166.845931] sd 8:0:0:3: [sde] Write Protect is off
[166.845933] sd 8:0:0:3: [sde] Mode Sense: 2f 00 00 00
[166.846424] scsi 7:0:0:1: Direct-Access LI0-ORG TCMU device > 0002 PQ: 0 ANSI: 5
[166.846552] sd 8:0:0:3: [sde] Write cache: enabled, read cache: > enabled, doesn't support DPO or FUA
[166.846708] sd 7:0:0:3: [sdf] 2097152 512-byte logical blocks: > (1.07 GB/1.00 GiB)
[166.847024] sd 8:0:0:1: Attached scsi generic sg8 type 0
[166.847029] sd 7:0:0:3: [sdf] Write Protect is off
[166.847031] sd 7:0:0:3: [sdf] Mode Sense: 2f 00 00 00
[166.847043] sd 8:0:0:3: [sde] Optimal transfer size 65536 bytes
[166.847133] sd 8:0:0:2: [sdg] 2097152 512-byte logical blocks: > (1.07 GB/1.00 GiB)
[166.849212] sd 8:0:0:2: [sdg] Write Protect is off
[166.849214] sd 8:0:0:2: [sdg] Mode Sense: 2f 00 00 00
[166.849711] sd 7:0:0:3: [sdf] Write cache: enabled, read cache: > enabled, doesn't support DPO or FUA
[166.849718] sd 7:0:0:1: Attached scsi generic sg9 type 0
[166.849721] sd 7:0:0:2: [sdh] 2097152 512-byte logical blocks: > (1.07 GB/1.00 GiB)
[166.853296] sd 8:0:0:2: [sdg] Write cache: enabled, read cache: > enabled, doesn't support DPO or FUA
[166.853721] sd 8:0:0:2: [sdg] Optimal transfer size 65536 bytes
[166.853810] sd 7:0:0:2: [sdh] Write Protect is off
[166.853812] sd 7:0:0:2: [sdh] Mode Sense: 2f 00 00 00
[166.854026] sd 7:0:0:3: [sdf] Optimal transfer size 65536 bytes
[166.854431] sd 7:0:0:2: [sdh] Write cache: enabled, read cache: > enabled, doesn't support DPO or FUA
[166.854625] sd 8:0:0:1: [sdi] 2097152 512-byte logical blocks: > (1.07 GB/1.00 GiB)
[166.854898] sd 8:0:0:1: [sdi] Write Protect is off
[166.854900] sd 8:0:0:1: [sdi] Mode Sense: 2f 00 00 00
[166.855022] sd 7:0:0:2: [sdh] Optimal transfer size 65536 bytes
[166.855465] sd 8:0:0:1: [sdi] Write cache: enabled, read cache: > enabled, doesn't support DPO or FUA
[166.855578] sd 7:0:0:1: [sdj] 2097152 512-byte logical blocks: > (1.07 GB/1.00 GiB)
[166.855845] sd 7:0:0:1: [sdj] Write Protect is off
[166.855847] sd 7:0:0:1: [sdj] Mode Sense: 2f 00 00 00
[166.855978] sd 8:0:0:1: [sdi] Optimal transfer size 65536 bytes
[166.856305] sd 7:0:0:1: [sdj] Write cache: enabled, read cache: > enabled, doesn't support DPO or FUA
[166.856701] sd 7:0:0:1: [sdj] Optimal transfer size 65536 bytes
[166.859624] sd 8:0:0:4: [sdd] Attached SCSI disk
[166.861304] sd 7:0:0:4: [sdc] Attached SCSI disk
[166.864409] sd 8:0:0:3: [sde] Attached SCSI disk
[166.864833] sd 7:0:0:3: [sdf] Attached SCSI disk
[166.867906] sd 8:0:0:2: [sdg] Attached SCSI disk
[166.868446] sd 8:0:0:1: [sdi] Attached SCSI disk
[166.871588] sd 7:0:0:1: [sdj] Attached SCSI disk
[166.871773] sd 7:0:0:2: [sdh] Attached SCSI disk

```

In the output above you will find **8 x SCSI disks** recognized. The storage server is mapping **4 x LUNs** to this node, AND the node has **2 x PATHs** to each LUN. The OS recognizes each path to each device as 1 SCSI device.

You will find different output depending on the storage server your node is mapping the LUNs from, and

the amount of LUNs being mapped as well.

Although not the objective of this session, let's find the 4 mapped LUNs using multipath-tools.

You will find further details about multipath in "Device Mapper Multipathing" session of this same guide.

```
$ apt-get install multipath-tools
$ sudo multipath -r
$ sudo multipath -ll
mpathd (360014051a042fb7c41c4249af9f2cfbc) dm-3 LI0-ORG,TCMU device
size=1.0G features='0' hwhandler='0' wp=rw
|+- policy='service-time 0' prio=1 status=active
| `-- 7:0:0:4 sde 8:64 active ready running
`-+- policy='service-time 0' prio=1 status=enabled
 `-- 8:0:0:4 sdc 8:32 active ready running
mpathc (360014050d6871110232471d8bcd155a3) dm-2 LI0-ORG,TCMU device
size=1.0G features='0' hwhandler='0' wp=rw
|+- policy='service-time 0' prio=1 status=active
| `-- 7:0:0:3 sdf 8:80 active ready running
`-+- policy='service-time 0' prio=1 status=enabled
 `-- 8:0:0:3 sdd 8:48 active ready running
mpathb (360014051f65c6cb11b74541b703celd4) dm-1 LI0-ORG,TCMU device
size=1.0G features='0' hwhandler='0' wp=rw
|+- policy='service-time 0' prio=1 status=active
| `-- 7:0:0:2 sdh 8:112 active ready running
`-+- policy='service-time 0' prio=1 status=enabled
 `-- 8:0:0:2 sdg 8:96 active ready running
mpatha (36001405b816e24fcab64fb88332a3fc9) dm-0 LI0-ORG,TCMU device
size=1.0G features='0' hwhandler='0' wp=rw
|+- policy='service-time 0' prio=1 status=active
| `-- 7:0:0:1 sdj 8:144 active ready running
`-+- policy='service-time 0' prio=1 status=enabled
 `-- 8:0:0:1 sdi 8:128 active ready running
```

Now it is much easier to understand each recognized SCSI device and common paths to same LUNs in the storage server. With the output above one can easily see that:

- **mpatha device** (/dev/mapper/mpatha) is a multipath device for:
  - /dev/sdj
  - /dev/dsi
- **mpathb device** (/dev/mapper/mpathb) is a multipath device for:
  - /dev/sdh
  - /dev/dsg
- **mpathc device** (/dev/mapper/mpathc) is a multipath device for:
  - /dev/sdf
  - /dev/sdd
- **mpathd device** (/dev/mapper/mpathd) is a multipath device for:
  - /dev/sde
  - /dev/sdc

**Do not use this in production** without checking appropriate multipath configuration options in the **Device Mapper Multipathing** session. The *default multipath configuration* is less than optimal for regular usage.

Finally, to access the LUN (or remote iSCSI disk) you will:

- If accessing through a single network interface:
  - access it through /dev/sdX where X is a letter given by the OS
- If accessing through multiple network interfaces:
  - configure multipath and access the device through /dev/mapper/X

For everything else, the created devices are block devices and all commands used with local disks should work the same way:

- Creating a partition:

```
$ sudo fdisk /dev/mapper/mpatha
```

```
Welcome to fdisk (util-linux 2.34).
Changes will remain in memory only, until you decide to write them.
Be careful before using the write command.
```

```
Device does not contain a recognized partition table.
Created a new DOS disklabel with disk identifier 0x92c0322a.
```

```
Command (m for help): p
Disk /dev/mapper/mpatha: 1 GiB, 1073741824 bytes, 2097152 sectors
Units: sectors of 1 * 512 = 512 bytes
Sector size (logical/physical): 512 bytes / 512 bytes
I/O size (minimum/optimal): 512 bytes / 65536 bytes
Disklabel type: dos
Disk identifier: 0x92c0322a
```

```
Command (m for help): n
Partition type
 p primary (0 primary, 0 extended, 4 free)
 e extended (container for logical partitions)
Select (default p): p
Partition number (1-4, default 1):
First sector (2048-2097151, default 2048):
Last sector, +/-sectors or +/-size{K,M,G,T,P} (2048-2097151, default 2097151):
```

```
Created a new partition 1 of type 'Linux' and of size 1023 MiB.
```

```
Command (m for help): w
The partition table has been altered.
```

- Creating a filesystem:

```
$ sudo mkfs.ext4 /dev/mapper/mpatha-part1
mke2fs 1.45.5 (07-Jan-2020)
Creating filesystem with 261888 4k blocks and 65536 inodes
Filesystem UUID: cdb70b1e-c47c-47fd-9c4a-03db6f038988
Superblock backups stored on blocks:
 32768, 98304, 163840, 229376
```

```
Allocating group tables: done
Writing inode tables: done
Creating journal (4096 blocks): done
Writing superblocks and filesystem accounting information: done
```

- Mounting the block device:

```
$ sudo mount /dev/mapper/mpatha-part1 /mnt
```

- Accessing the data:

```
$ ls /mnt
lost+found
```

Make sure to read other important sessions in Ubuntu Server Guide to follow up with concepts explored in this one.

## References

1. [iscsid](#)
2. [iscsi.conf](#)
3. [iscsid.conf](#)
4. [iscsi.service](#)
5. [iscsid.service](#)
6. [Open-iSCSI](#)
7. [Debian Open-iSCSI](#)

NFS allows a system to share directories and files with others over a network. By using NFS, users and programs can access files on remote systems almost as if they were local files.

Some of the most notable benefits that NFS can provide are:

- Local workstations use less disk space because commonly used data can be stored on a single machine and still remain accessible to others over the network.
- There is no need for users to have separate home directories on every network machine. Home directories could be set up on the NFS server and made available throughout the network.
- Storage devices such as floppy disks, CDROM drives, and USB Thumb drives can be used by other machines on the network. This may reduce the number of removable media drives throughout the network.

## Installation

At a terminal prompt enter the following command to install the NFS Server:

```
sudo apt install nfs-kernel-server
```

To start the NFS server, you can run the following command at a terminal prompt:

```
sudo systemctl start nfs-kernel-server.service
```

## Configuration

You can configure the directories to be exported by adding them to the `/etc/exports` file. For example:

```
/srv *(ro,sync,subtree_check)
/home *.hostname.com(rw,sync,no_subtree_check)
/scratch *(rw,async,no_subtree_check,no_root_squash)
```

Make sure any custom mount points you're adding have been created (`/srv` and `/home` will already exist):

```
sudo mkdir /scratch
```

Apply the new config via:

```
sudo exportfs -a
```

You can replace `*` with one of the hostname formats. Make the hostname declaration as specific as possible so unwanted systems cannot access the NFS mount. Be aware that `*.hostname.com` will match `foo.hostname.com` but not `foo.bar.my-domain.com`.

The *sync/async* options control whether changes are guaranteed to be committed to stable storage before replying to requests. *async* thus gives a performance benefit but risks data loss or corruption. Even though *sync* is the default, it's worth setting since `exportfs` will issue a warning if it's left unspecified.

*subtree\_check* and *no\_subtree\_check* enables or disables a security verification that subdirectories a client attempts to mount for an exported filesystem are ones they're permitted to do so. This verification step has some performance implications for some use cases, such as home directories with frequent file renames. Read-only filesystems are more suitable to enable *subtree\_check* on. Like with *sync*, `exportfs` will warn if it's left unspecified.

There are a number of optional settings for NFS mounts for tuning performance, tightening security, or providing conveniences. These settings each have their own trade-offs so it is important to use them with care, only as needed for the particular use case. *no\_root\_squash*, for example, adds a convenience to allow root-owned files to be modified by any client system's root user; in a multi-user environment where executables are allowed on a shared mount point, this could lead to security problems.

## NFS Client Configuration

To enable NFS support on a client system, enter the following command at the terminal prompt:

```
sudo apt install nfs-common
```

Use the `mount` command to mount a shared NFS directory from another machine, by typing a command line similar to the following at a terminal prompt:

```
sudo mkdir /opt/example
sudo mount example.hostname.com:/srv /opt/example
```

## Warning

The mount point directory `/opt/example` must exist. There should be no files or subdirectories in the `/opt/example` directory, else they will become inaccessible until the `nfs` filesystem is unmounted.

An alternate way to mount an NFS share from another machine is to add a line to the `/etc/fstab` file. The line must state the hostname of the NFS server, the directory on the server being exported, and the directory on the local machine where the NFS share is to be mounted.

The general syntax for the line in `/etc/fstab` file is as follows:

```
example.hostname.com:/srv /opt/example nfs rsize=8192,wsiz=8192,timeo=14,intr
```

## Advanced Configuration

NFS is comprised of several services, both on the server and the client. Each one of these services can have its own default configuration, and depending on the Ubuntu Server release you have installed, this configuration is done in different files, and with a different syntax.

### Ubuntu Server 22.04 LTS (“jammy”)

All NFS related services read a single configuration file: `/etc/nfs.conf`. This is a INI-style config file, see the [nfs.conf\(5\)](#) manpage for details. Furthermore, there is a `/etc/nfs.conf.d` directory which can hold `*.conf` snippets that can override settings from previous snippets or from the `nfs.conf` main config file itself.

There is a new command-line tool called `nfsconf(8)` which can be used to query or even set configuration parameters in `nfs.conf`. In particular, it has a `--dump` parameter which will show the effective configuration including all changes done by `/etc/nfs.conf.d/*.conf` snippets.

### For Ubuntu Server 20.04 LTS (“focal”) and earlier

Earlier Ubuntu releases use the traditional configuration mechanism for the NFS services via `/etc/default/` configuration files. These are `/etc/default/nfs-common` and `/etc/default/nfs/kernel-server`, and are used basically to adjust the command-line options given to each daemon.

Each file has a small explanation about the available settings.

#### Warning

The `NEED_*` parameters have no effect on systemd-based installations, like Ubuntu 20.04 LTS (“focal”) and Ubuntu 18.04 LTS (“bionic”).

In those systems, to control whether a service should be running or not, use `systemctl enable` or `systemctl disable`, respectively.

## Upgrading to Ubuntu 22.04 LTS (“jammy”)

The main change to the NFS packages in Ubuntu 22.04 LTS (“jammy”) is the configuration file. Instead of multiple files sourced by startup scripts from `/etc/default/nfs-*`, now there is one main configuration file in `/etc/nfs.conf`, with an INI-style syntax.

When upgrading to Ubuntu 22.04 LTS (“jammy”) from a release that still uses the `/etc/default/nfs-*` configuration files, the following will happen:

- a default `/etc/nfs.conf` configuration file will be installed
- if the `/etc/default/nfs-*` files have been modified, a conversion script will be run and it will create `/etc/nfs.conf.d/local.conf` with the local modifications.

If this conversion script fails, then the package installation will fail. This can happen if the `/etc/default/nfs-*` files have an option that the conversion script wasn’t prepared to handle, or a syntax error for example. In such cases, please file a bug using this link: <https://bugs.launchpad.net/ubuntu/+source/nfs-utils/+filebug>

You can run the conversion tool manually to gather more information about the error: it’s in `/usr/share/nfs-common/nfsconvert.py` and must be run as `root`.

If all goes well, as it should in most cases, the system will have `/etc/nfs.conf` with the defaults, and `/etc/nfs.conf.d/local.conf` with the changes. You can merge these two together manually, and then delete `local.conf`, or leave it as is. Just keep in mind that `/etc/nfs.conf` is not the whole story: always inspect `/etc/nfs.conf.d` as well, as it may contain files overriding the defaults.

You can always run `nfsconf --dump` to check the final settings, as it merges together all configuration files and shows the resulting non-default settings.

## Restarting NFS services

Since NFS is comprised of several individual services, it can be difficult to determine what to restart after a certain configuration change.

The tables below summarize all available services, which “meta” service they are linked to, and which configuration file each service uses.

Service	nfs-utils.service	nfs-server.service	config file (22.04)	config file (< 22.04) /etc/default/nfs-*
nfs-blkmap	PartOf		nfs.conf	
nfs-mountd		BindsTo	nfs.conf	nfs-kernel-server
nfsdclld				
nfs-idmapd		BindsTo	nfs.conf, idmapd.conf	idmapd.conf
rpc-gssd	PartOf		nfs.conf	
rpc-statd	PartOf		nfs.conf	nfs-common
rpc-svcgssd	PartOf	BindsTo	nfs.conf	nfs-kernel-server

For example, `systemctl restart nfs-server.service` will restart `nfs-mountd`, `nfs-idmapd` and `rpc-svcgssd` (if running). On the other hand, restarting `nfs-utils.service` will restart `nfs-blkmap`, `rpc-gssd`, `rpc-statd` and `rpc-svcgssd`.

Of course, each service can still be individually restarted with the usual `systemctl restart <service>`.

The `nfs.systemd(7)` manpage has more details on the several `systemd` units available with the NFS packages.

## NFSv4 with Kerberos

Kerberos with NFS adds an extra layer of security on top of NFS. It can be just a stronger authentication mechanism, or it can also be used to sign and encrypt the NFS traffic.

This section will assume you already have setup a Kerberos server, with a running KDC and admin services. Setting that up is explained elsewhere in the Ubuntu Server Guide.

### NFS server (using kerberos)

The NFS server will have the usual `nfs-kernel-server` package and its dependencies, but we will also have to install kerberos packages. The kerberos packages are not strictly necessary, as the necessary keys can be copied over from the KDC, but it makes things much easier.

For this example, we will use:

- `.vms` DNS domain
- `VMS` Kerberos realm
- `j-nfs-server.vms` for the NFS server
- `j-nfs-client.vms` for the NFS client
- `ubuntu/admin` principal has admin privileges on the KDC

Adjust these names according to your setup.

First, install the `krb5-user` package:

```
sudo apt install krb5-user
```

Then, with an admin principal, let's create a key for the NFS server:

```
$ sudo kadmin -p ubuntu/admin -q "addprinc -randkey nfs/j-nfs-server.vms"
```

And extract the key into the local keytab:

```
$ sudo kadmin -p ubuntu/admin -q "ktadd nfs/j-nfs-server.vms"
```

```
Authenticating as principal ubuntu/admin with password.
```

```
Password for ubuntu/admin@VMS:
```

```
Entry for principal nfs/j-nfs-server.vms with kvno 2, encryption type aes256-cts-hmac-sha1-96 added to keytab FILE:/etc/k
```

```
Entry for principal nfs/j-nfs-server.vms with kvno 2, encryption type aes128-cts-hmac-sha1-96 added to keytab FILE:/etc/k
```

Confirm the key is available:

```
$ sudo klist -k
```

```
Keytab name: FILE:/etc/krb5.keytab
```

```
KVNO Principal
```

```

```



```
2 nfs/j-nfs-server.vms@VMS
2 nfs/j-nfs-server.vms@VMS
```

Now install the NFS server:

```
$ sudo apt install nfs-kernel-server
```

This will already automatically start the kerberos-related nfs services, because of the presence of `/etc/krb5.keytab`.

Now populate `/etc/exports`, restricting the exports to krb5 authentication. For example, exporting `/storage` using krb5p:

```
/storage *(rw, sync, no_subtree_check, sec=krb5p)
```

Refresh the exports:

```
$ sudo exportfs -rav
exporting */storage
```

The security options are explained in the [exports\(5\)](#) manpage, but generally they are:

- krb5: use kerberos for authentication only (non-auth traffic is in clear text)
- krb5i: use kerberos for authentication and integrity checks (non-auth traffic is in clear text)
- krb5p: use kerberos for authentication, integrity and privacy protection (non-auth traffic is encrypted)

### NFS client (using kerberos)

The NFS client has a similar set of steps. First we will prepare the client's keytab, so that when we install the NFS client package it will start the extra kerberos services automatically just by detecting the presence of the keytab:

```
sudo apt install krb5-user
```

To allow the `root` user to mount NFS shares via kerberos without a password, we have to create a host key for the NFS client:

```
sudo kadmin -p ubuntu/admin -q "addprinc -randkey host/j-nfs-client.vms"
```

And extract it:

```
$ sudo kadmin -p ubuntu/admin -q "ktadd host/j-nfs-client.vms"
```

Now install the NFS client package:

```
$ sudo apt install nfs-common
```

And you should be able to do your first NFS kerberos mount:

```
$ sudo mount j-nfs-server:/storage /mnt
```

If you are using a machine credential, then the above mount will work without having a kerberos ticket, i.e., `klist` will show no tickets:

```
mount j-nfs-server:/storage /mnt
ls -l /mnt/*
-rw-r--r-- 1 root root 0 Apr 5 14:50 /mnt/hello-from-nfs-server.txt
klist
klist: No credentials cache found (filename: /tmp/krb5cc_0)
```

Notice the above was done with `root`. Let's try accessing that existing mount with the `ubuntu` user, without acquiring a kerberos ticket:

```
sudo -u ubuntu -i
$ ls -l /mnt/*
ls: cannot access '/mnt/*': Permission denied
```

The `ubuntu` user will only be able to access that mount if they have a kerberos ticket:

```
$ kinit
Password for ubuntu@VMS:
$ ls -l /mnt/*
-rw-r--r-- 1 root root 0 Apr 5 14:50 /mnt/hello-from-nfs-server.txt
```

And now we have not only the TGT, but also a ticket for the NFS service:

```

$ klist
Ticket cache: FILE:/tmp/krb5cc_1000
Default principal: ubuntu@VMS

Valid starting Expires Service principal
04/05/22 17:48:50 04/06/22 03:48:50 krbtgt/VMS@VMS
 renew until 04/06/22 17:48:48
04/05/22 17:48:52 04/06/22 03:48:50 nfs/j-nfs-server.vms@
 renew until 04/06/22 17:48:48
Ticket server: nfs/j-nfs-server.vms@VMS

```

One drawback of using a machine credential for mounts done by the `root` user is that you need a persistent secret (the `/etc/krb5.keytab` file) in the filesystem. Some sites may not allow such a persistent secret to be stored in the filesystem. An alternative is to use `rpc.gssds -n` option. From `rpc.gssd(8)`:

- `-n`: when specified, UID 0 is forced to obtain user credentials which are used instead of the local system's machine credentials.

When this option is enabled and `rpc.gssd` restarted, then even the `root` user will need to obtain a kerberos ticket to perform an NFS kerberos mount.

#### Warning

Note that this prevents automatic NFS mounts via `/etc/fstab`, unless a kerberos ticket is obtained before.

In Ubuntu 22.04 LTS (“jammy”), this option is controlled in `/etc/nfs.conf` in the `[gssd]` section:

```

[gssd]
use-machine-creds=0

```

In older Ubuntu releases, the command line options for the `rpc.gssd` daemon are not exposed in `/etc/default/nfs-common`, therefore a `systemd` override file needs to be created. You can either run:

```
$ sudo systemctl edit rpc-gssd.service
```

And paste the following into the editor that will open:

```

[Service]
ExecStart=
ExecStart=/usr/sbin/rpc.gssd $GSSDARGS -n

```

Or manually create the file `/etc/systemd/system/rpc-gssd.service.d/override.conf` and any needed directories up to it, with the contents above.

After you restart the service with `systemctl restart rpc-gssd.service`, the `root` user won't be able to mount the NFS kerberos share without obtaining a ticket first.

## References

[Linux NFS wiki](#)

[Linux NFS faq](#)

[Ubuntu Wiki NFS Howto](#)

[Ubuntu Wiki NFSv4 Howto](#)

## Introduction

OpenSSH is a powerful collection of tools for the remote control of, and transfer of data between, networked computers. You will also learn about some of the configuration settings possible with the OpenSSH server application and how to change them on your Ubuntu system.

OpenSSH is a freely available version of the Secure Shell (SSH) protocol family of tools for remotely controlling, or transferring files between, computers. Traditional tools used to accomplish these functions, such as `telnet` or `rcp`, are insecure and transmit the user's password in cleartext when used. OpenSSH provides a server daemon and client tools to facilitate secure, encrypted remote control and file transfer operations, effectively replacing the legacy tools.

The OpenSSH server component, `sshd`, listens continuously for client connections from any of the client tools. When a connection request occurs, `sshd` sets up the correct connection depending on the type of client tool connecting. For example, if the remote computer is connecting with the `ssh` client application, the OpenSSH server sets up a remote control session after authentication. If a remote user connects to an OpenSSH server with `scp`, the OpenSSH server

daemon initiates a secure copy of files between the server and client after authentication. OpenSSH can use many authentication methods, including plain password, public key, and Kerberos tickets.

## Installation

Installation of the OpenSSH client and server applications is simple. To install the OpenSSH client applications on your Ubuntu system, use this command at a terminal prompt:

```
sudo apt install openssh-client
```

To install the OpenSSH server application, and related support files, use this command at a terminal prompt:

```
sudo apt install openssh-server
```

## Configuration

You may configure the default behavior of the OpenSSH server application, `sshd`, by editing the file `/etc/ssh/sshd_config`. For information about the configuration directives used in this file, you may view the appropriate manual page with the following command, issued at a terminal prompt:

```
man sshd_config
```

There are many directives in the `sshd` configuration file controlling such things as communication settings, and authentication modes. The following are examples of configuration directives that can be changed by editing the `/etc/ssh/sshd_config` file.

### Tip

Prior to editing the configuration file, you should make a copy of the original file and protect it from writing so you will have the original settings as a reference and to reuse as necessary.

Copy the `/etc/ssh/sshd_config` file and protect it from writing with the following commands, issued at a terminal prompt:

```
sudo cp /etc/ssh/sshd_config /etc/ssh/sshd_config.original
sudo chmod a-w /etc/ssh/sshd_config.original
```

Furthermore since losing an ssh server might mean losing your way to reach a server, check the configuration after changing it and before restarting the server:

```
sudo sshd -t -f /etc/ssh/sshd_config
```

The following is an *example* of a configuration directive you may change:

- To make your OpenSSH server display the contents of the `/etc/issue.net` file as a pre-login banner, simply add or modify this line in the `/etc/ssh/sshd_config` file:

```
Banner /etc/issue.net
```

After making changes to the `/etc/ssh/sshd_config` file, save the file, and restart the `sshd` server application to effect the changes using the following command at a terminal prompt:

```
sudo systemctl restart sshd.service
```

### Warning

Many other configuration directives for `sshd` are available to change the server application's behavior to fit your needs. Be advised, however, if your only method of access to a server is `ssh`, and you make a mistake in configuring `sshd` via the `/etc/ssh/sshd_config` file, you may find you are locked out of the server upon restarting it. Additionally, if an incorrect configuration directive is supplied, the `sshd` server may refuse to start, so be extra careful when editing this file on a remote server.

## SSH Keys

SSH allow authentication between two hosts without the need of a password. SSH key authentication uses a *private key* and a *public key*.

To generate the keys, from a terminal prompt enter:

```
ssh-keygen -t rsa
```

This will generate the keys using the *RSA Algorithm*. At the time of this writing, the generated keys will have 3072 bits. You can modify the number of bits by using the `-b` option. For example, to generate keys with 4096 bits, you can do:

```
ssh-keygen -t rsa -b 4096
```

During the process you will be prompted for a password. Simply hit *Enter* when prompted to create the key.

By default the *public* key is saved in the file `~/.ssh/id_rsa.pub`, while `~/.ssh/id_rsa` is the *private* key. Now copy the `id_rsa.pub` file to the remote host and append it to `~/.ssh/authorized_keys` by entering:

```
ssh-copy-id username@remotehost
```

Finally, double check the permissions on the `authorized_keys` file, only the authenticated user should have read and write permissions. If the permissions are not correct change them by:

```
chmod 600 ~/.ssh/authorized_keys
```

You should now be able to SSH to the host without being prompted for a password.

## Import keys from public key servers

These days many users have already ssh keys registered with services like launchpad or github. Those can be easily imported with:

```
ssh-import-id <username-on-remote-service>
```

The prefix `lp:` is implied and means fetching from launchpad, the alternative `gh:` will make the tool fetch from github instead.

## Two factor authentication with U2F/FIDO

OpenSSH 8.2 [added support for U2F/FIDO hardware authentication devices](#). These devices are used to provide an extra layer of security on top of the existing key-based authentication, as the hardware token needs to be present to finish the authentication.

It's very simple to use and setup. The only extra step is generate a new keypair that can be used with the hardware device. For that, there are two key types that can be used: `ecdsa-sk` and `ed25519-sk`. The former has broader hardware support, while the latter might need a more recent device.

Once the keypair is generated, it can be used as you would normally use any other type of key in openssh. The only requirement is that in order to use the private key, the U2F device has to be present on the host.

For example, plug the U2F device in and generate a keypair to use with it:

```
$ ssh-keygen -t ecdsa-sk
Generating public/private ecdsa-sk key pair.
You may need to touch your authenticator to authorize key generation. <-- touch device
Enter file in which to save the key (/home/ubuntu/.ssh/id_ecdsa_sk):
Enter passphrase (empty for no passphrase):
Enter same passphrase again:
Your identification has been saved in /home/ubuntu/.ssh/id_ecdsa_sk
Your public key has been saved in /home/ubuntu/.ssh/id_ecdsa_sk.pub
The key fingerprint is:
SHA256:V9PQ1MqaU8F0DXdHqDiH9Mxb8XK3o5aVYDQLVl9IFRo ubuntu@focal
```

Now just transfer the public part to the server to `~/.ssh/authorized_keys` and you are ready to go:

```
$ ssh -i .ssh/id_ecdsa_sk ubuntu@focal.server
Confirm user presence for key ECDSA-SK SHA256:V9PQ1MqaU8F0DXdHqDiH9Mxb8XK3o5aVYDQLVl9IFRo <-- touch device
Welcome to Ubuntu Focal Fossa (GNU/Linux 5.4.0-21-generic x86_64)
(...)
ubuntu@focal.server:~$
```

## FIDO2 resident keys

FIDO2 private keys consist of two parts: a “key handle” part stored in the private key file on disk, and a per-device key that is unique to each FIDO2 token and that cannot be exported from the token hardware. These are combined by the hardware at authentication time to derive the real key that is used to sign authentication challenges.

For tokens that are required to move between computers, it can be cumbersome to have to move the private key file first. To avoid this, tokens implementing the newer FIDO2 standard support *resident keys*, where it is possible to retrieve the key handle part of the key from the hardware.

Using resident keys increases the likelihood of an attacker being able to use a stolen token device. For this reason, tokens normally enforce PIN authentication before allowing download of keys, and users should set a PIN on their tokens before creating any resident keys. This is done via the hardware token management software.

OpenSSH allows resident keys to be generated using the `ssh-keygen -0 resident` flag at key generation time:

```
$ ssh-keygen -t ecdsa-sk -0 resident -0 application=ssh:mykeyname
Generating public/private ecdsa-sk key pair.
You may need to touch your authenticator to authorize key generation.
Enter PIN for authenticator:
Enter file in which to save the key (/home/ubuntu/.ssh/id_ecdsa_sk): mytoken
Enter passphrase (empty for no passphrase):
Enter same passphrase again:
Your identification has been saved in mytoken
(...)
```

This will produce a public/private key pair as usual, but it will be possible to retrieve the private key part (the key handle) from the token later. This is done by running:

```
$ ssh-keygen -K
Enter PIN for authenticator:
You may need to touch your authenticator to authorize key download.
Enter passphrase (empty for no passphrase):
Enter same passphrase again:
Saved ECDSA-SK key ssh:mytoken to id_ecdsa_sk_rk_mytoken
```

It will use the part after `ssh:` from the *application* parameter from before as part of the key filenames:

```
$ ls id_ecdsa_sk_rk_mytoken*
-rw----- 1 ubuntu ubuntu 598 out 4 18:49 id_ecdsa_sk_rk_mytoken
-rw-r--r-- 1 ubuntu ubuntu 228 out 4 18:49 id_ecdsa_sk_rk_mytoken.pub
```

If you set a passphrase when extracting the keys from the hardware token, and later use these keys, you will be prompted for both the key passphrase, and the hardware key PIN, and you will also have to touch the token:

```
$ ssh -i ./id_ecdsa_sk_rk_mytoken ubuntu@focal.server
Enter passphrase for key './id_ecdsa_sk_rk_mytoken':
Confirm user presence for key ECDSA-SK
SHA256:t+l26IgTXeURY6e36wtrq7wVYJtDVZr0+iuobs1CvVQ
User presence confirmed
(...)
```

It is also possible to download and add resident keys directly to `ssh-agent` by running

```
$ ssh-add -K
```

In this case no file is written, and the public key can be printed by running `ssh-add -L`.

#### NOTE

If you used the `-0 verify-required` option when generating the keys, or if that option is set on the SSH server via `/etc/ssh/sshd_config`'s `PubkeyAuthOptions verify-required`, then using the agent currently in Ubuntu 22.04 LTS won't work.

## Two factor authentication with TOTP/HOTP

For the best two factor authentication (2FA) security, we recommend using hardware authentication devices that support U2F/FIDO. See the previous section for details. However, if this is not possible or practical to implement in your case, TOTP/HOTP based 2FA is an improvement over no two factor at all. Smartphone apps to support this type of 2FA are common, such as Google Authenticator.

### Background

The configuration presented here makes public key authentication the first factor, the TOTP/HOTP code the second factor, and makes password authentication unavailable. Apart from the usual setup steps required for public key authentication, all configuration and setup takes place on the server. No changes are required at the client end; the 2FA prompt appears in place of the password prompt.

The two supported methods are HOTP and TOTP. Generally, TOTP is preferable if the 2FA device supports it.

**HOTP** is based on a sequence predictable only to those who share a secret. The user must take an action to cause the client to generate the next code in the sequence, and this response is sent to the server. The server also generates the

next code, and if it matches the one supplied by the user, then the user has proven to the server that they share the secret. A downside of this approach is that if the user generates codes without the server following along, such as in the case of a typo, then the sequence generators can fall “out of sync”. Servers compensate by allowing a gap in the sequence and considering a few subsequent codes to also be valid; if this mechanism is used, then the server “skips ahead” to sync back up. But to remain secure, this can only go so far before the server must refuse. When HOTP falls out of sync like this, it must be reset using some out of band method, such as authenticating using a second backup key in order to reset the secret for the first one.

**TOTP** avoids this downside of HOTP by using the current timezone independent date and time to determine the appropriate position in the sequence. However, this results in additional requirements and a different failure mode. Both devices must have the ability to tell the time, which is not practical for a USB 2FA token with no battery, for example. And both the server and client must agree on the correct time. If their clocks are skewed, then they will disagree on their current position in the sequence. Servers compensate for clock skew by allowing a few codes either side to also be valid. But like HOTP, they can only go so far before the server must refuse. One advantage of TOTP over HOTP is that correcting for this condition involves ensuring the clocks are correct at both ends; an out-of-band authentication to reset unfortunate users’ secrets is not required. When using a modern smartphone app, for example, the requirement to keep the clock correct isn’t usually a problem since this is typically done automatically at both ends by default.

#### Note

It is not recommended to configure U2F/FIDO at the same time as TOTP/HOTP. This combination has not been tested, and using the configuration presented here, TOTP/HOTP would become mandatory for everyone, whether or not they are also using U2F/FIDO.

## Install software

From a terminal prompt, install the `google-authenticator` PAM module:

```
sudo apt update
sudo apt install libpam-google-authenticator
```

#### Note

The `libpam-google-authenticator` package is in Ubuntu’s universe archive component, which receives best-effort community support only.

## Configure users

Since public key authentication with TOTP/HOTP 2FA is about to be configured to be mandatory for users, each user who wishes to continue using ssh must first set up public key authentication and then configure their 2FA keys by running the user setup tool. If this isn’t done first, users will not be able to do it later over ssh, since at that point they won’t have public key authentication and/or 2FA configured to authenticate with.

## Configure users’ key-based authentication

To set up key-based authentication, see “SSH Keys” above. Once this is done, it can be tested independently of subsequent 2FA configuration. At this stage, user authentication should work with keys only, requiring the supply of the private key passphrase only if it was configured. If configured correctly, the user should not be prompted for their password.

## Configure users’ TOTP/HOTP 2FA secrets

Each user needs to run the setup tool to configure 2FA. This will ask some questions, generate a key, and display a QR code for the user to import the secret into their smartphone app, such as the Google Authenticator app on Android. The tool creates the file `~/.google-authenticator`, which contains a shared secret, emergency passcodes and per-user configuration.

As a user that needs 2FA configured, from a terminal prompt run the following command:

```
google-authenticator
```

Follow the prompts, scanning the QR code into your 2FA app as directed.

It’s important to plan for the eventuality that the 2FA device gets lost or damaged. Will this lock the user out of their account? In mitigation, it’s worth each user considering doing one or more of the following:

- Use the 2FA device’s backup or cloud sync facility if it has one.
- Write down the backup codes printed by the setup tool.
- Take a photo of the QR code.

- (TOTP only) Scan the QR code on multiple 2FA devices. This only works for TOTP, since multiple HOTP 2FA devices will not be able to stay in sync.
- Ensure that the user has a different authentication path to be able to rerun the setup tool if required.

Of course, any of these backup steps also negate any benefit of 2FA should someone else get access to the backup, so the steps taken to protect any backup should be considered carefully.

### Configure the ssh server

Once all users are configured, configure sshd itself by editing `/etc/ssh/sshd_config`. Depending on your installation, some of these settings may be configured already, but not necessarily with the values required for this configuration. Check for and adjust existing occurrences of these configuration directives, or add new ones, as required:

```
KbdInteractiveAuthentication yes
PasswordAuthentication no
AuthenticationMethods publickey,keyboard-interactive
```

Note

On Ubuntu 20.04 “Focal Fossa” and earlier, use `ChallengeResponseAuthentication yes` instead of `KbdInteractiveAuthentication yes`.

Restart the ssh service to pick up configuration changes:

```
sudo systemctl try-reload-or-restart ssh
```

Edit `/etc/pam.d/sshd` and replace the line:

```
@include common-auth
```

with:

```
auth required pam_google_authenticator.so
```

Changes to PAM configuration have immediate effect, and no separate reloading command is required.

### Log in using 2FA

Now when you log in using ssh, in addition to the normal public key authentication, you will be prompted for your TOTP or HOTP code:

```
$ ssh jammy.server
Enter passphrase for key 'id_rsa':
(ubuntu@jammy.server) Verification code:
Welcome to Ubuntu Jammy Jellyfish...
(...)
ubuntu@jammy.server:~$
```

### Special cases

On Ubuntu, the following settings are default in `/etc/ssh/sshd_config`, but if you have overridden them, note that they are required for this configuration to work correctly and must be restored as follows:

```
UsePAM yes
PubkeyAuthentication yes
```

Remember to run `sudo systemctl try-reload-or-restart ssh` for any changes made to sshd configuration to take effect.

### References

- [Ubuntu Wiki SSH page](#).
- [OpenSSH Website](#)
- [OpenSSH 8.2 release notes](#)
- [Advanced OpenSSH Wiki Page](#)
- [Yubikey documentation for OpenSSH FIDO/FIDO2 usage](#)
- [Wikipedia on TOTP](#)
- [Wikipedia on HOTP](#)

OpenVPN is a Virtual Private Networking (VPN) solution provided in the Ubuntu Repositories. It is flexible, reliable and secure. It belongs to the family of SSL/TLS VPN stacks (different from IPsec VPNs). This chapter will cover installing and configuring OpenVPN to create a VPN.

If you want more than just pre-shared keys OpenVPN makes it easy to set up a Public Key Infrastructure (PKI) to use SSL/TLS certificates for authentication and key exchange between the VPN server and clients. OpenVPN can be used in a routed or bridged VPN mode and can be configured to use either UDP or TCP. The port number can be configured as well, but port 1194 is the official one; this single port is used for all communication. VPN client implementations are available for almost anything including all Linux distributions, macOS, Windows and OpenWRT-based WLAN routers.

## Server Installation

To install `openvpn` in a terminal enter:

```
sudo apt install openvpn easy-rsa
```

## Public Key Infrastructure Setup

The first step in building an OpenVPN configuration is to establish a PKI (public key infrastructure). The PKI consists of:

- a separate certificate (also known as a public key) and private key for the server and each client.
- a master Certificate Authority (CA) certificate and key, used to sign the server and client certificates.

OpenVPN supports bidirectional authentication based on certificates, meaning that the client must authenticate the server certificate and the server must authenticate the client certificate before mutual trust is established.

Both server and client will authenticate the other by first verifying that the presented certificate was signed by the master certificate authority (CA), and then by testing information in the now-authenticated certificate header, such as the certificate common name or certificate type (client or server).

## Certificate Authority Setup

To setup your own Certificate Authority (CA) and generate certificates and keys for an OpenVPN server and multiple clients first copy the `easy-rsa` directory to `/etc/openvpn`. This will ensure that any changes to the scripts will not be lost when the package is updated. From a terminal, run:

```
sudo make-cadir /etc/openvpn/easy-rsa
```

Note: If desired, you can alternatively edit `/etc/openvpn/easy-rsa/vars` directly, adjusting it to your needs.

As root user change to the newly created directory `/etc/openvpn/easy-rsa` and run:

```
./easysrsa init-pki
./easysrsa build-ca
```

## Server Keys and Certificates

Next, we will generate a key pair for the server:

```
./easysrsa gen-req myservername nopass
```

Diffie Hellman parameters must be generated for the OpenVPN server. The following will place them in `pki/dh.pem`.

```
./easysrsa gen-dh
```

And finally a certificate for the server:

```
./easysrsa gen-req myservername nopass
./easysrsa sign-req server myservername
```

All certificates and keys have been generated in subdirectories. Common practice is to copy them to `/etc/openvpn/`:

```
cp pki/dh.pem pki/ca.crt pki/issued/myservername.crt pki/private/myservername.key /etc/openvpn/
```

## Client Certificates

The VPN client will also need a certificate to authenticate itself to the server. Usually you create a different certificate for each client.



This can either be done on the server (as the keys and certificates above) and then securely distributed to the client. Or vice versa: the client can generate and submit a request that is sent and signed by the server.

To create the certificate, enter the following in a terminal while being user root:

```
./easysrsa gen-req myclient1 nopass
./easysrsa sign-req client myclient1
```

If the first command above was done on a remote system, then copy the .req file to the CA server. There you can then import it via `easysrsa import-req /incoming/myclient1.req myclient1`. Then you can go on with the second `sign-req` command.

In both cases, afterwards copy the following files to the client using a secure method:

- `pki/ca.crt`
- `pki/issued/myclient1.crt`

As the client certificates and keys are only required on the client machine, you can remove them from the server.

## Simple Server Configuration

Along with your OpenVPN installation you got these sample config files (and many more if you check):

```
root@server:/# ls -l /usr/share/doc/openvpn/examples/sample-config-files/
total 68
-rw-r--r-- 1 root root 3427 2011-07-04 15:09 client.conf
-rw-r--r-- 1 root root 4141 2011-07-04 15:09 server.conf.gz
```

Start with copying and unpacking `server.conf.gz` to `/etc/openvpn/server.conf`.

```
sudo cp /usr/share/doc/openvpn/examples/sample-config-files/server.conf.gz /etc/openvpn/myserver.conf.gz
sudo gzip -d /etc/openvpn/myserver.conf.gz
```

Edit `/etc/openvpn/myserver.conf` to make sure the following lines are pointing to the certificates and keys you created in the section above.

```
ca ca.crt
cert myservername.crt
key myservername.key
dh dh2048.pem
```

Complete this set with a `ta` key in `etc/openvpn` for `tls-auth` like:

```
sudo openvpn --genkey --secret ta.key
```

Edit `/etc/sysctl.conf` and uncomment the following line to enable IP forwarding.

```
#net.ipv4.ip_forward=1
```

Then reload `sysctl`.

```
sudo sysctl -p /etc/sysctl.conf
```

That is the minimum you have to configure to get a working OpenVPN server. You can use all the default settings in the sample `server.conf` file. Now start the server.

Be aware that the `“systemctl start openvpn”` is **not** starting your `openvpn` you just defined.

Openvpn uses templated systemd jobs, `openvpn@CONFIGFILENAME`. So if for example your configuration file is `myserver.conf` your service is called `openvpn@myserver`. You can run all kinds of service and `systemctl` commands like `start/stop/enable/disable/preset` against a templated service like `openvpn@server`.

```
$ sudo systemctl start openvpn@myserver
```

You will find logging and error messages in the journal. For example, if you started a [templated service](#) `openvpn@server` you can filter for this particular message source with:

```
sudo journalctl -u openvpn@myserver -xe
```

The same templated approach works for all of `systemctl`:

```
$ sudo systemctl status openvpn@myserver
openvpn@myserver.service - OpenVPN connection to myserver
 Loaded: loaded (/lib/systemd/system/openvpn@.service; disabled; vendor preset: enabled)
 Active: active (running) since Thu 2019-10-24 10:59:25 UTC; 10s ago
 Docs: man:openvpn(8)
```

```

https://community.openvpn.net/openvpn/wiki/Openvpn24ManPage
https://community.openvpn.net/openvpn/wiki/HOWTO
Main PID: 4138 (openvpn)
Status: "Initialization Sequence Completed"
Tasks: 1 (limit: 533)
Memory: 1.0M
CGroup: /system.slice/system-openvpn.slice/openvpn@myserver.service
└─4138 /usr/sbin/openvpn --daemon ovpn-myserver --status /run/openvpn/myserver.status 10 --
cd /etc/openvpn --script-security 2 --config /etc/openvpn/myserver.conf --writepid /run/

Oct 24 10:59:26 eoan-vpn-server ovpn-myserver[4138]: /sbin/ip addr add dev tun0 local 10.8.0.1 peer 10.8.0.2
Oct 24 10:59:26 eoan-vpn-server ovpn-myserver[4138]: /sbin/ip route add 10.8.0.0/24 via 10.8.0.2
Oct 24 10:59:26 eoan-vpn-server ovpn-myserver[4138]: Could not determine IPv4/IPv6 protocol. Using AF_INET
Oct 24 10:59:26 eoan-vpn-server ovpn-myserver[4138]: Socket Buffers: R=[212992->212992] S=[212992->212992]
Oct 24 10:59:26 eoan-vpn-server ovpn-myserver[4138]: UDPv4 link local (bound): [AF_INET][undef]:1194
Oct 24 10:59:26 eoan-vpn-server ovpn-myserver[4138]: UDPv4 link remote: [AF_UNSPEC]
Oct 24 10:59:26 eoan-vpn-server ovpn-myserver[4138]: MULTI: multi_init called, r=256 v=256
Oct 24 10:59:26 eoan-vpn-server ovpn-myserver[4138]: IFCONFIG POOL: base=10.8.0.4 size=62, ipv6=0
Oct 24 10:59:26 eoan-vpn-server ovpn-myserver[4138]: IFCONFIG POOL LIST
Oct 24 10:59:26 eoan-vpn-server ovpn-myserver[4138]: Initialization Sequence Completed

```

You can enable/disable various openvpn services on one system, but you could also let Ubuntu do it for you. There is config for `AUTOSTART` in `/etc/default/openvpn`. Allowed values are “all”, “none” or space separated list of names of the VPNs. If empty, “all” is assumed. The VPN name refers to the VPN configuration file name. i.e. `home` would be `/etc/openvpn/home.conf` If you’re running `systemd`, changing this variable will require running `systemctl daemon-reload` followed by a *restart* of the openvpn service (if you removed entries you may have to stop those manually).

After “`systemctl daemon-reload`” a restart of the “generic” openvpn will restart all dependent services that the generator in `/lib/systemd/system-generators/openvpn-generator` created for your conf files when you called `daemon-reload`.

Now check if OpenVPN created a `tun0` interface:

```

root@server:/etc/openvpn# ip addr show dev tun0
5: tun0: <POINTOPOINT,MULTICAST,NOARP,UP,LOWER_UP> mtu 1500 qdisc fq_codel state UNKNOWN group default qlen 100
 link/none
 inet 10.8.0.1 peer 10.8.0.2/32 scope global tun0
 valid_lft forever preferred_lft forever
 inet6 fe80::b5ac:7829:f31e:32c5/64 scope link stable-privacy
 valid_lft forever preferred_lft forever

```

## Simple Client Configuration

There are various different OpenVPN client implementations with and without GUIs. You can read more about clients in a later section on [VPN Clients](#). For now we use commandline/service based OpenVPN client for Ubuntu which is part of the very same package as the server. So you have to install the `openvpn` package again on the client machine:

```
sudo apt install openvpn
```

This time copy the `client.conf` sample config file to `/etc/openvpn/`:

```
sudo cp /usr/share/doc/openvpn/examples/sample-config-files/client.conf /etc/openvpn/
```

Copy the following client keys and certificate files you created in the section above to e.g. `/etc/openvpn/` and edit `/etc/openvpn/client.conf` to make sure the following lines are pointing to those files. If you have the files in `/etc/openvpn/` you can omit the path.

```

ca ca.crt
cert myclient1.crt
key myclient1.key
tls-auth ta.key 1

```

And you have to specify the OpenVPN server name or address. Make sure the keyword `client` is in the config. That’s what enables client mode.

```

client
remote vpnserver.example.com 1194

```

Now start the OpenVPN client with the same templated mechanism:

```
$ sudo systemctl start openvpn@client
```

You can check status as you did on the server:

```
$ sudo systemctl status openvpn@client
openvpn@client.service - OpenVPN connection to client
 Loaded: loaded (/lib/systemd/system/openvpn@.service; disabled; vendor preset: enabled)
 Active: active (running) since Thu 2019-10-24 11:42:35 UTC; 6s ago
 Docs: man:openvpn(8)
 https://community.openvpn.net/openvpn/wiki/Openvpn24ManPage
 https://community.openvpn.net/openvpn/wiki/HOWTO
 Main PID: 3616 (openvpn)
 Status: "Initialization Sequence Completed"
 Tasks: 1 (limit: 533)
 Memory: 1.3M
 CGroup: /system.slice/system-openvpn.slice/openvpn@client.service
 └─3616 /usr/sbin/openvpn --daemon ovpn-client --status /run/openvpn/client.status 10 --
cd /etc/openvpn --script-security 2 --config /etc/openvpn/client.conf --writepid /run/openvp
```

```
Oct 24 11:42:36 eoan-vpn-client ovpn-client[3616]: Outgoing Data Channel: Cipher 'AES-256-GCM' initialized with 256 bit ke
Oct 24 11:42:36 eoan-vpn-client ovpn-client[3616]: Incoming Data Channel: Cipher 'AES-256-GCM' initialized with 256 bit ke
Oct 24 11:42:36 eoan-vpn-client ovpn-client[3616]: ROUTE_GATEWAY 192.168.122.1/255.255.255.0 IFACE=ens3 HWADDR=52:54:00:
Oct 24 11:42:36 eoan-vpn-client ovpn-client[3616]: TUN/TAP device tun0 opened
Oct 24 11:42:36 eoan-vpn-client ovpn-client[3616]: TUN/TAP TX queue length set to 100
Oct 24 11:42:36 eoan-vpn-client ovpn-client[3616]: /sbin/ip link set dev tun0 up mtu 1500
Oct 24 11:42:36 eoan-vpn-client ovpn-client[3616]: /sbin/ip addr add dev tun0 local 10.8.0.6 peer 10.8.0.5
Oct 24 11:42:36 eoan-vpn-client ovpn-client[3616]: /sbin/ip route add 10.8.0.1/32 via 10.8.0.5
Oct 24 11:42:36 eoan-vpn-client ovpn-client[3616]: WARNING: this configuration may cache passwords in memory -
- use the auth-nocache option to prevent this
Oct 24 11:42:36 eoan-vpn-client ovpn-client[3616]: Initialization Sequence Completed
```

On the server log an incoming connection looks like the following.

You can see client name and source address as well as success/failure messages.

```
ovpn-myserver[4818]: 192.168.122.114:55738 TLS: Initial packet from [AF_INET]192.168.122.114:55738, sid=5e943ab8 40ab9fe
ovpn-myserver[4818]: 192.168.122.114:55738 VERIFY OK: depth=1, CN=Easy-RSA CA
ovpn-myserver[4818]: 192.168.122.114:55738 VERIFY OK: depth=0, CN=myclient1
ovpn-myserver[4818]: 192.168.122.114:55738 peer info: IV_VER=2.4.7
ovpn-myserver[4818]: 192.168.122.114:55738 peer info: IV_PLAT=linux
ovpn-myserver[4818]: 192.168.122.114:55738 peer info: IV_PROTO=2
ovpn-myserver[4818]: 192.168.122.114:55738 peer info: IV_NCP=2
ovpn-myserver[4818]: 192.168.122.114:55738 peer info: IV_LZ4=1
ovpn-myserver[4818]: 192.168.122.114:55738 peer info: IV_LZ4v2=1
ovpn-myserver[4818]: 192.168.122.114:55738 peer info: IV_LZ0=1
ovpn-myserver[4818]: 192.168.122.114:55738 peer info: IV_COMP_STUB=1
ovpn-myserver[4818]: 192.168.122.114:55738 peer info: IV_COMP_STUBv2=1
ovpn-myserver[4818]: 192.168.122.114:55738 peer info: IV_TCPNL=1
ovpn-myserver[4818]: 192.168.122.114:55738 Control Channel: TLSv1.3, cipher TLSv1.3 TLS_AES_256_GCM_SHA384, 2048 bit RSA
ovpn-myserver[4818]: 192.168.122.114:55738 [myclient1] Peer Connection Initiated with [AF_INET]192.168.122.114:55738
ovpn-myserver[4818]: myclient1/192.168.122.114:55738 MULTI_sva: pool returned IPv4=10.8.0.6, IPv6=(Not enabled)
ovpn-myserver[4818]: myclient1/192.168.122.114:55738 MULTI: Learn: 10.8.0.6 -> myclient1/192.168.122.114:55738
ovpn-myserver[4818]: myclient1/192.168.122.114:55738 MULTI: primary virtual IP for myclient1/192.168.122.114:55738: 10.8
ovpn-myserver[4818]: myclient1/192.168.122.114:55738 PUSH: Received control message: 'PUSH_REQUEST'
ovpn-myserver[4818]: myclient1/192.168.122.114:55738 SENT CONTROL [myclient1]: 'PUSH_REPLY,route 10.8.0.1,topology net3
restart 120,ifconfig 10.8.0.6 10.8.0.5,peer-id 0,cipher AES-256-GCM' (status=1)
ovpn-myserver[4818]: myclient1/192.168.122.114:55738 Data Channel: using negotiated cipher 'AES-256-GCM'
ovpn-myserver[4818]: myclient1/192.168.122.114:55738 Outgoing Data Channel: Cipher 'AES-256-GCM' initialized with 256 bi
ovpn-myserver[4818]: myclient1/192.168.122.114:55738 Incoming Data Channel: Cipher 'AES-256-GCM' initialized with 256 bi
```

And you can check on the client if it created a tun0 interface:

```
$ ip addr show dev tun0
4: tun0: <POINTOPOINT,MULTICAST,NOARP,UP,LOWER_UP> mtu 1500 qdisc fq_codel state UNKNOWN group default qlen 100
 link/none
 inet 10.8.0.6 peer 10.8.0.5/32 scope global tun0
 valid_lft forever preferred_lft forever
 inet6 fe80::5a94:ae12:8901:5a75/64 scope link stable-privacy
```

```
valid_lft forever preferred_lft forever
```

Check if you can ping the OpenVPN server:

```
root@client:/etc/openvpn# ping 10.8.0.1
PING 10.8.0.1 (10.8.0.1) 56(84) bytes of data.
64 bytes from 10.8.0.1: icmp_req=1 ttl=64 time=0.920 ms
```

### Note

The OpenVPN server always uses the first usable IP address in the client network and only that IP is pingable. E.g. if you configured a /24 for the client network mask, the .1 address will be used. The P-t-P address you see in the `ip addr` output above is usually not answering ping requests.

Check out your routes:

```
$ ip route
default via 192.168.122.1 dev ens3 proto dhcp src 192.168.122.114 metric 100
10.8.0.1 via 10.8.0.5 dev tun0
10.8.0.5 dev tun0 proto kernel scope link src 10.8.0.6
192.168.122.0/24 dev ens3 proto kernel scope link src 192.168.122.114
192.168.122.1 dev ens3 proto dhcp scope link src 192.168.122.114 metric 100
```

## First trouble shooting

If the above didn't work for you, check this:

- Check your journal `-xe`
- Check that you have specified the keyfile names correctly in client and server conf files
- Can the client connect to the server machine? Maybe a firewall is blocking access? Check journal on server.
- Client and server must use same protocol and port, e.g. UDP port 1194, see port and proto config option
- Client and server must use same config regarding compression, see `comp-lzo` config option
- Client and server must use same config regarding bridged vs routed mode, see server vs server-bridge config option

## Advanced configuration

### Advanced routed VPN configuration on server

The above is a very simple working VPN. The client can access services on the VPN server machine through an encrypted tunnel. If you want to reach more servers or anything in other networks, push some routes to the clients. E.g. if your company's network can be summarized to the network 192.168.0.0/16, you could push this route to the clients. But you will also have to change the routing for the way back - your servers need to know a route to the VPN client-network.

The example config files that we have been using in this guide are full of all these advanced options in the form of a comment and a disabled configuration line as an example.

### Note

Please read the OpenVPN [hardening security guide](#) for further security advice.

### Advanced bridged VPN configuration on server

OpenVPN can be setup for either a routed or a bridged VPN mode. Sometimes this is also referred to as OSI layer-2 versus layer-3 VPN. In a bridged VPN all layer-2 frames - e.g. all ethernet frames - are sent to the VPN partners and in a routed VPN only layer-3 packets are sent to VPN partners. In bridged mode all traffic including traffic which was traditionally LAN-local like local network broadcasts, DHCP requests, ARP requests etc. are sent to VPN partners whereas in routed mode this would be filtered.

### Prepare interface config for bridging on server

First, use netplan to configure a bridge device using the desired ethernet device.

```
$ cat /etc/netplan/01-netcfg.yaml
network:
 version: 2
 renderer: networkd
 ethernets:
 enp0s31f6:
```

```

 dhcp4: no
bridges:
 br0:
 interfaces: [enp0s31f6]
 dhcp4: no
 addresses: [10.0.1.100/24]
 gateway4: 10.0.1.1
 nameservers:
 addresses: [10.0.1.1]

```

Static IP addressing is highly suggested. DHCP addressing can also work, but you will still have to encode a static address in the OpenVPN configuration file.

The next step on the server is to configure the ethernet device for promiscuous mode on boot. To do this, ensure the networkd-dispatcher package is installed and create the following configuration script.

```

sudo apt update
sudo apt install networkd-dispatcher
sudo touch /usr/lib/networkd-dispatcher/dormant.d/promisc_bridge
sudo chmod +x /usr/lib/networkd-dispatcher/dormant.d/promisc_bridge

```

Then add the following contents.

```

#!/bin/sh
set -e
if ["$IFACE" = br0]; then
 # no networkd-dispatcher event for 'carrier' on the physical interface
 ip link set enp0s31f6 up promisc on
fi

```

### Prepare server config for bridging

Edit `/etc/openvpn/server.conf` to use tap rather than tun and set the server to use the server-bridge directive:

```

;dev tun
dev tap
;server 10.8.0.0 255.255.255.0
server-bridge 10.0.0.4 255.255.255.0 10.0.0.128 10.0.0.254

```

After configuring the server, restart openvpn by entering:

```

sudo systemctl restart openvpn@myserver

```

### Prepare client config for bridging

The only difference on the client side for bridged mode to what was outlined above is that you need to edit `/etc/openvpn/client.conf` and set tap mode:

```

dev tap
;dev tun

```

Finally, restart openvpn:

```

sudo systemctl restart openvpn@client

```

You should now be able to connect to the full remote LAN through the VPN.

## References

- [EasyRSA](#)
- [OpenVPN quick start guide](#)
- [Snap'ed version of openvpn easy-openvpn](#)
- [Debian's OpenVPN Guide](#)

## Installing a gitolite server

Gitolite provides a traditional source control management server for git, with multiple users and access rights management. gitolite can be installed with the following command:

```

sudo apt install gitolite3

```

## Gitolite configuration

Configuration of the gitolite server is a little different than most other servers on Unix-like systems, in that gitolite stores its configuration in a git repository rather than in files in `/etc/`. The first step to configuring a new installation is therefore to allow access to the configuration repository.

First of all, let's create a user for gitolite to use for the service:

```
sudo adduser --system --shell /bin/bash --group --disabled-password --home /home/git git
```

Now we want to let gitolite know about the repository administrator's public SSH key. This assumes that the current user is the repository administrator. If you have not yet configured an SSH key, refer to [openssh-keys](#) in this manual.

```
cp ~/.ssh/id_rsa.pub /tmp/$(whoami).pub
```

Let's switch to the git user and import the administrator's key into gitolite.

```
sudo su - git
gl-setup /tmp/*.pub
```

Gitolite will allow you to make initial changes to its configuration file during the setup process. You can now clone and modify the gitolite configuration repository from your administrator user (the user whose public SSH key you imported). Switch back to that user, then clone the configuration repository:

```
exit
git clone git@$IP_ADDRESS:gitolite-admin.git
cd gitolite-admin
```

The gitolite-admin contains two subdirectories, "conf" and "keydir". The configuration files are in the conf dir, and the keydir directory contains the list of user's public SSH keys.

## Managing gitolite users and repositories

Adding a new user to gitolite is simple: just obtain their public SSH key and add it to the keydir directory as `$DESIRED_USER_NAME.pub`. Note that the gitolite usernames don't have to match the system usernames - they are only used in the gitolite configuration file to manage access control. Similarly, users are deleted by deleting their public key files. After each change, do not forget to commit the changes to git, and push the changes back to the server with

```
git commit -a
git push origin master
```

Repositories are managed by editing the `conf/gitolite.conf` file. The syntax is space separated, and simply specifies the list of repositories followed by some access rules. The following is a default example

```
repo gitolite-admin
 RW+ = admin
 R = alice

repo project1
 RW+ = alice
 RW = bob
 R = denise
```

## Using your server

Once a user's public key has been imported by the gitolite admin and authorization granted to the user to one or more repositories, the user can access repositories with the following command:

```
git clone git@$SERVER_IP:$PROJECT_NAME.git
```

To add the server as a new remote for an existing git repository:

```
git remote add gitolite git@$SERVER_IP:$PROJECT_NAME.git
```

## References

- [Gitolite's code repository](#) provides access to source code.
- [Gitolite's documentation](#) includes a "fool proof setup" guide and a cookbook with recipes for common tasks.
- Gitolite's maintainer has written a book, *Gitolite Essentials*, for more in-depth information about the software.
- General information about git itself can be found at the [Git homepage](#).

## Linux Network-Manager GUI for OpenVPN

Many Linux distributions including Ubuntu desktop variants come with Network Manager, a nice GUI to configure your network settings. It also can manage your VPN connections. It is the default, but if in doubt make sure you have package `network-manager-openvpn` installed.

Open the Network Manager GUI, select the VPN tab and then the ‘Add’ button. Select OpenVPN as the VPN type in the opening requester and press ‘Create’. In the next window add the OpenVPN’s server name as the ‘Gateway’, set ‘Type’ to ‘Certificates (TLS)’, point ‘User Certificate’ to your user certificate, ‘CA Certificate’ to your CA certificate and ‘Private Key’ to your private key file. Use the advanced button to enable compression (e.g. `comp-lzo`), dev tap, or other special settings you set on the server. Now try to establish your VPN.

## OpenVPN with GUI for Mac OS X

- [Tunnelblick](#) is an excellent free, open source implementation of a GUI for OpenVPN for OS X. Download the latest OS X installer from there and install it. It also is [recommended by upstream](#) which would have a [alternative](#) on their own

Then put your client.ovpn config file together with the certificates and keys in `/Users/username/Library/Application Support/Tunnelblick/Configurations/` and launch Tunnelblick from your Application folder.

Instead of downloading manually, if you have brew set up on MacOS this is as easy as:

```
brew cask install tunnelblick
```

## OpenVPN with GUI for Win

First download and install the latest [OpenVPN Windows Installer](#). As of this writing, the management GUI is included with the Windows binary installer.

You need to start the OpenVPN service. Goto Start > Computer > Manage > Services and Applications > Services. Find the OpenVPN service and start it. Set it’s startup type to automatic.

When you start the OpenVPN MI GUI the first time you need to run it as an administrator. You have to right click on it and you will see that option.

There is an [updated guide by the upstream](#) project for the client on Windows.

## References

- See the [OpenVPN](#) website for additional information.
- [OpenVPN hardening security guide](#)
- Also, Pakt’s [OpenVPN: Building and Integrating Virtual Private Networks](#) is a good resource.

One of the most useful applications for any system administrator is an xterm multiplexor such as `screen` or `tmux`. It allows for the execution of multiple shells in one terminal. To make some of the advanced multiplexor features more user-friendly and provide some useful information about the system, the `byobu` package was created. It acts as a wrapper to these programs. By default `Byobu` is installed in Ubuntu server and it uses `tmux` (if installed) but this can be changed by the user.

Invoke it simply with:

```
byobu
```

Now bring up the configuration menu. By default this is done by pressing the `F9` key. This will allow you to:

- Help – Quick Start Guide
- Toggle status notifications
- Change the escape sequence
- `Byobu` currently does not launch at login (toggle on)

`byobu` provides a menu which displays the Ubuntu release, processor information, memory information, and the time and date. The effect is similar to a desktop menu.

Using the “*Byobu currently does not launch at login (toggle on)*” option will cause `byobu` to be executed any time a terminal is opened. Changes made to `byobu` are on a per user basis, and will not affect other users on the system.

One difference when using `byobu` is the `scrollback` mode. Press the `F7` key to enter `scrollback` mode. `Scrollback` mode allows you to navigate past output using *vi* like commands. Here is a quick list of movement commands:

- *h* - Move the cursor left by one character
- *j* - Move the cursor down by one line
- *k* - Move the cursor up by one line
- *l* - Move the cursor right by one character
- *0* - Move to the beginning of the current line
- *\$* - Move to the end of the current line
- *G* - Moves to the specified line (defaults to the end of the buffer)
- */* - Search forward
- *?* - Search backward
- *n* - Moves to the next match, either forward or backward

## Resources

- For more information on screen see the [screen web site](#).
- And the [Ubuntu Wiki screen](#) page.
- Also, see the byobu [project page](#) for more information.

etckeeper allows the contents of `/etc` to be stored in a Version Control System (VCS) repository. It integrates with APT and automatically commits changes to `/etc` when packages are installed or upgraded. Placing `/etc` under version control is considered an industry best practice, and the goal of etckeeper is to make this process as painless as possible.

Install etckeeper by entering the following in a terminal:

```
sudo apt install etckeeper
```

The main configuration file, `/etc/etckeeper/etckeeper.conf`, is fairly simple. The main option is which VCS to use and by default etckeeper is configured to use git. The repository is automatically initialized (and committed for the first time) during package installation. It is possible to undo this by entering the following command:

```
sudo etckeeper uninit
```

By default, etckeeper will commit uncommitted changes made to `/etc` daily. This can be disabled using the `AVOID_DAILY_AUTOCOMMITS` configuration option. It will also automatically commit changes before and after package installation. For a more precise tracking of changes, it is recommended to commit your changes manually, together with a commit message, using:

```
sudo etckeeper commit "Reason for configuration change"
```

The `vcs etckeeper` command allows to run any subcommand of the VCS that etckeeper is configured to run. `t` will be run in `/etc`. For example, in the case of git:

```
sudo etckeeper vcs log /etc/passwd
```

To demonstrate the integration with the package management system (APT), install postfix:

```
sudo apt install postfix
```

When the installation is finished, all the postfix configuration files should be committed to the repository:

```
[master 5a16a0d] committing changes in /etc made by "apt install postfix"
Author: Your Name <xyz@example.com>
36 files changed, 2987 insertions(+), 4 deletions(-)
create mode 100755 init.d/postfix
create mode 100644 insserv.conf.d/postfix
create mode 100755 network/if-down.d/postfix
create mode 100755 network/if-up.d/postfix
create mode 100644 postfix/dynamicmaps.cf
create mode 100644 postfix/main.cf
create mode 100644 postfix/main.cf.proto
create mode 120000 postfix/makedefs.out
create mode 100644 postfix/master.cf
create mode 100644 postfix/master.cf.proto
create mode 100755 postfix/post-install
create mode 100644 postfix/postfix-files
```



```

create mode 100755 postfix/postfix-script
create mode 100755 ppp/ip-down.d/postfix
create mode 100755 ppp/ip-up.d/postfix
create mode 120000 rc0.d/K01postfix
create mode 120000 rc1.d/K01postfix
create mode 120000 rc2.d/S01postfix
create mode 120000 rc3.d/S01postfix
create mode 120000 rc4.d/S01postfix
create mode 120000 rc5.d/S01postfix
create mode 120000 rc6.d/K01postfix
create mode 100755 resolvconf/update-libc.d/postfix
create mode 100644 rsyslog.d/postfix.conf
create mode 120000 systemd/system/multi-user.target.wants/postfix.service
create mode 100644 ufw/applications.d/postfix

```

For an example of how etckeeper tracks manual changes, add new a host to `/etc/hosts`. Using git you can see which files have been modified:

```
sudo etckeeper vcs status
```

and how:

```
sudo etckeeper vcs diff
```

If you are happy with the changes you can now commit them:

```
sudo etckeeper commit "added new host"
```

## Resources

- See the [etckeeper](#) site for more details on using etckeeper.
- For documentation on the git VCS tool see the [Git](#) website.

## Installation

Before installing Munin on *server01* apache2 will need to be installed. The default configuration is fine for running a munin server. For more information see the [Apache2 Web Server](#) guide.

First, on *server01* install munin. In a terminal enter:

```
sudo apt install munin
```

Now on *server02* install the munin-node package:

```
sudo apt install munin-node
```

## Configuration

On *server01* edit the `/etc/munin/munin.conf` adding the IP address for *server02*:

```
First our "normal" host.
[server02]
 address 172.18.100.101
```

### Note

Replace *server02* and *172.18.100.101* with the actual hostname and IP address for your server.

Next, configure munin-node on *server02*. Edit `/etc/munin/munin-node.conf` to allow access by *server01*:

```
allow ^172\.18\.100\.100$
```

### Note

Replace `^172\.18\.100\.100$` with IP address for your munin server.

Now restart munin-node on *server02* for the changes to take effect:

```
sudo systemctl restart munin-node.service
```

Finally, in a browser go to `http://server01/munin`, and you should see links to nice graphs displaying information from the standard *munin-plugins* for disk, network, processes, and system.

## Note

Since this is a new install it may take some time for the graphs to display anything useful.

## Additional Plugins

The `munin-plugins-extra` package contains performance checks additional services such as DNS, DHCP, Samba, etc. To install the package, from a terminal enter:

```
sudo apt install munin-plugins-extra
```

Be sure to install the package on both the server and node machines.

## References

- See the [Munin](#) website for more details.
- Specifically the [Munin Documentation](#) page includes information on additional plugins, writing plugins, etc.

## Installation

First, on *server01* install the nagios package. In a terminal enter:

```
sudo apt install nagios3 nagios-nrpe-plugin
```

You will be asked to enter a password for the *nagiosadmin* user. The user's credentials are stored in `/etc/nagios3/htpasswd.users`. To change the *nagiosadmin* password, or add additional users to the Nagios CGI scripts, use the `htpasswd` that is part of the `apache2-utils` package.

For example, to change the password for the *nagiosadmin* user enter:

```
sudo htpasswd /etc/nagios3/htpasswd.users nagiosadmin
```

To add a user:

```
sudo htpasswd /etc/nagios3/htpasswd.users steve
```

Next, on *server02* install the `nagios-nrpe-server` package. From a terminal on *server02* enter:

```
sudo apt install nagios-nrpe-server
```

## Note

NRPE allows you to execute local checks on remote hosts. There are other ways of accomplishing this through other Nagios plugins as well as other checks.

## Configuration Overview

There are a couple of directories containing Nagios configuration and check files.

- `/etc/nagios3`: contains configuration files for the operation of the nagios daemon, CGI files, hosts, etc.
- `/etc/nagios-plugins`: houses configuration files for the service checks.
- `/etc/nagios`: on the remote host contains the `nagios-nrpe-server` configuration files.
- `/usr/lib/nagios/plugins/`: where the check binaries are stored. To see the options of a check use the `-h` option.

For example: `/usr/lib/nagios/plugins/check_dhcp -h`

There are a plethora of checks Nagios can be configured to execute for any given host. For this example Nagios will be configured to check disk space, DNS, and a MySQL hostgroup. The DNS check will be on *server02*, and the MySQL hostgroup will include both *server01* and *server02*.

## Note

See ??? for details on setting up Apache, ??? for DNS, and ??? for MySQL.

Additionally, there are some terms that once explained will hopefully make understanding Nagios configuration easier:

- *Host*: a server, workstation, network device, etc that is being monitored.
- *Host Group*: a group of similar hosts. For example, you could group all web servers, file server, etc.
- *Service*: the service being monitored on the host. Such as HTTP, DNS, NFS, etc.

- *Service Group*: allows you to group multiple services together. This is useful for grouping multiple HTTP for example.
- *Contact*: person to be notified when an event takes place. Nagios can be configured to send emails, SMS messages, etc.

By default Nagios is configured to check HTTP, disk space, SSH, current users, processes, and load on the *localhost*. Nagios will also ping check the *gateway*.

Large Nagios installations can be quite complex to configure. It is usually best to start small, one or two hosts, get things configured the way you like then expand.

## Configuration

- First, create a *host* configuration file for *server02*. Unless otherwise specified, run all these commands on *server01*. In a terminal enter:

```
sudo cp /etc/nagios3/conf.d/localhost_nagios2.cfg \
/etc/nagios3/conf.d/server02.cfg
```

### Note

In the above and following command examples, replace “*server01*”, “*server02*” *172.18.100.100*, and *172.18.100.101* with the host names and IP addresses of your servers.

Next, edit */etc/nagios3/conf.d/server02.cfg*:

```
define host{
 use generic-host ; Name of host template to use
 host_name server02
 alias Server 02
 address 172.18.100.101
}

check DNS service.
define service {
 use generic-service
 host_name server02
 service_description DNS
 check_command check_dns!172.18.100.101
}
```

Restart the nagios daemon to enable the new configuration:

```
sudo systemctl restart nagio3.service
```

- Now add a service definition for the MySQL check by adding the following to */etc/nagios3/conf.d/services\_nagios2.cfg*:

```
check MySQL servers.
define service {
 hostgroup_name mysql-servers
 service_description MySQL
 check_command check_mysql_cmdlinecred!nagios!secret!$HOSTADDRESS
 use generic-service
 notification_interval 0 ; set > 0 if you want to be renotified
}
```

A *mysql-servers* hostgroup now needs to be defined. Edit */etc/nagios3/conf.d/hostgroups\_nagios2.cfg* adding:

```
MySQL hostgroup.
define hostgroup {
 hostgroup_name mysql-servers
 alias MySQL servers
 members localhost, server02
}
```

The Nagios check needs to authenticate to MySQL. To add a *nagios* user to MySQL enter:

```
mysql -u root -p -e "create user nagios identified by 'secret';"
```

## Note

The *nagios* user will need to be added all hosts in the *mysql-servers* hostgroup.

Restart nagios to start checking the MySQL servers.

```
sudo systemctl restart nagios3.service
```

- Lastly configure NRPE to check the disk space on *server02*.

On *server01* add the service check to `/etc/nagios3/conf.d/server02.cfg`:

```
NRPE disk check.
define service {
 use generic-service
 host_name server02
 service_description nrpe-disk
 check_command check_nrpe_larg!check_all_disks!172.18.100.101
}

```

Now on *server02* edit `/etc/nagios/nrpe.cfg` changing:

```
allowed_hosts=172.18.100.100
```

And below in the command definition area add:

```
command[check_all_disks]=usr/lib/nagios/plugins/check_disk -w 20% -c 10% -e
```

Finally, restart nagios-nrpe-server:

```
sudo systemctl restart nagios-nrpe-server.service
```

Also, on *server01* restart nagios:

```
sudo systemctl restart nagios3.service
```

You should now be able to see the host and service checks in the Nagios CGI files. To access them point a browser to `http://server01/nagios3`. You will then be prompted for the *nagiosadmin* username and password.

## References

This section has just scratched the surface of Nagios' features. The *nagios-plugins-extra* and *nagios-snmp-plugins* contain many more service checks.

- For more information see [Nagios website](#).
- Specifically the [Nagios Online Documentation](#) site.
- There is also a list of [books](#) related to Nagios and network monitoring:
- The [Nagios Ubuntu Wiki](#) page also has more details.

When logging into an Ubuntu server you may have noticed the informative Message Of The Day (MOTD). This information is obtained and displayed using a couple of packages:

- *landscape-common*: provides the core libraries of *landscape-client*, which is needed to manage systems with [Landscape](#) (proprietary). Yet the package also includes the *landscape-sysinfo* utility which is responsible for displaying core system data involving cpu, memory, disk space, etc. For instance:

```
System load: 0.0 Processes: 76
Usage of /: 30.2% of 3.11GB Users logged in: 1
Memory usage: 20% IP address for eth0: 10.153.107.115
Swap usage: 0%
```

Graph this data and manage this system at <https://landscape.canonical.com/>

## Note

You can run *landscape-sysinfo* manually at any time.

- *update-notifier-common*: provides information on available package updates, impending filesystem checks (fsck), and required reboots (e.g.: after a kernel upgrade).

*pam\_motd* executes the scripts in `/etc/update-motd.d` in order based on the number prepended to the script. The output of the scripts is written to `/var/run/motd`, keeping the numerical order, then concatenated with `/etc/motd.tail`.

You can add your own dynamic information to the MOTD. For example, to add local weather information:

- First, install the weather-util package:

```
sudo apt install weather-util
```

- The weather utility uses METAR data from the National Oceanic and Atmospheric Administration and forecasts from the National Weather Service. In order to find local information you will need the 4-character ICAO location indicator. This can be determined by browsing to the [National Weather Service](#) site.

Although the National Weather Service is a United States government agency there are weather stations available world wide. However, local weather information for all locations outside the U.S. may not be available.

- Create `/usr/local/bin/local-weather`, a simple shell script to use weather with your local ICAO indicator:

```
#!/bin/sh
#
#
Prints the local weather information for the MOTD.
#
#

Replace KINT with your local weather station.
Local stations can be found here: http://www.weather.gov/tg/siteloc.shtml

echo
weather KINT
echo
```

- Make the script executable:

```
sudo chmod 755 /usr/local/bin/local-weather
```

- Next, create a symlink to `/etc/update-motd.d/98-local-weather`:

```
sudo ln -s /usr/local/bin/local-weather /etc/update-motd.d/98-local-weather
```

- Finally, exit the server and re-login to view the new MOTD.

You should now be greeted with some useful information, and some information about the local weather that may not be quite so useful. Hopefully the local-weather example demonstrates the flexibility of `pam_motd`.

## Resources

- See the [update-motd man page](#) for more options available to `update-motd`.
- The Debian Package of the Day [weather](#) article has more details about using the weather utility.

Puppet is a cross platform framework enabling system administrators to perform common tasks using code. The code can do a variety of tasks from installing new software, to checking file permissions, or updating user accounts. Puppet is great not only during the initial installation of a system, but also throughout the system's entire life cycle. In most circumstances puppet will be used in a client/server configuration.

This section will cover installing and configuring Puppet in a client/server configuration. This simple example will demonstrate how to install Apache using Puppet.

## Preconfiguration

Prior to configuring puppet you may want to add a DNS *CNAME* record for `puppet.example.com`, where `example.com` is your domain. By default Puppet clients check DNS for `puppet.example.com` as the puppet server name, or *Puppet Master*. See [Domain Name Server](#) for more details.

If you do not wish to use DNS, you can add entries to the server and client `/etc/hosts` file. For example, in the Puppet server's `/etc/hosts` file add:

```
127.0.0.1 localhost.localdomain localhost puppet
192.168.1.17 puppetclient.example.com puppetclient
```

On each Puppet client, add an entry for the server:

```
192.168.1.16 puppetmaster.example.com puppetmaster puppet
```

### Note

Replace the example IP addresses and domain names above with your actual server and client addresses and domain names.

## Installation

To install Puppet, in a terminal on the *server* enter:

```
sudo apt install puppetmaster
```

On the *client* machine, or machines, enter:

```
sudo apt install puppet
```

## Configuration

Create a folder path for the apache2 class:

```
sudo mkdir -p /etc/puppet/modules/apache2/manifests
```

Now setup some resources for apache2. Create a file `/etc/puppet/modules/apache2/manifests/init.pp` containing the following:

```
class apache2 {
 package { 'apache2':
 ensure => installed,
 }

 service { 'apache2':
 ensure => true,
 enable => true,
 require => Package['apache2'],
 }
}
```

Next, create a node file `/etc/puppet/code/environments/production/manifests/site.pp` with:

```
node 'puppetclient.example.com' {
 include apache2
}
```

### Note

Replace `puppetclient.example.com` with your actual Puppet client's host name.

The final step for this simple Puppet server is to restart the daemon:

```
sudo systemctl restart puppetmaster.service
```

Now everything is configured on the Puppet server, it is time to configure the client.

First, configure the Puppet agent daemon to start. Edit `/etc/default/puppet`, changing *START* to yes:

```
START=yes
```

Then start the service:

```
sudo systemctl start puppet.service
```

View the client cert fingerprint

```
sudo puppet agent --fingerprint
```

Back on the Puppet server, view pending certificate signing requests:

```
sudo puppet cert list
```

On the Puppet server, verify the fingerprint of the client and sign puppetclient's cert:

```
sudo puppet cert sign puppetclient.example.com
```

On the Puppet client, run the puppet agent manually in the foreground. This step isn't strictly speaking necessary, but it is the best way to test and debug the puppet service.

```
sudo puppet agent --test
```

Check `/var/log/syslog` on both hosts for any errors with the configuration. If all goes well the `apache2` package and its dependencies will be installed on the Puppet client.

### Note

This example is *very* simple, and does not highlight many of Puppet's features and benefits. For more information see [Resources](#).

## Resources

- See the [Official Puppet Documentation](#) web site.
- See the [Puppet forge](#), online repository of puppet modules.
- Also see [Pro Puppet](#).

---

Generated from the online docs at <https://ubuntu.com/server/docs> on Sun Jun 11 09:05:36 UTC 2023